

HCO-7020RA

QHD (4MP) Analog IR Bullet Camera



Key Features

- QHD (2560 x 1440, 30fps) resolution
- 0.27 Lux@F2.0 (Color), 0 Lux (B/W : IR LED on)
- Built-in 4.0mm fixed lens
- Day & Night (ICR), DWDR, Motion detection
- IR Viewable Length 25m
- Transmission distance max.500m
- Easy installation (Plug & play), IP66, IK10

Accessories (Optional)



SBO-100B1



SBP-302PM

Video	
Imaging Device	1/3" 4MP CMOS
Resolution	2560x1440
Max. Framerate	30fps@4M(N), 25fps@4M(P)
Min. Illumination	Color: 0.27Lux(F2.0, 1/30sec) BW: 0Lux(IR LED on)
Video Out	BNC(AHD), additional CVBS for installation(2Pin connector type)
Video Transmission Distance	500m(5C2V Coaxial Cable)
Lens	
Focal Length (Zoom Ratio)	4.0mm fixed
Max. Aperture Ratio	F2.0
Angular Field of View	H: 78.22°, V: 41.21°, D: 87.91°
Min. Object Distance	0.5m(1.64ft)
Operational	
Day & Night	Auto(ICR)
Backlight Compensation	UserBLC, HLC, DWDR
Digital Noise Reduction	2DDNR
Motion Detection	4 zones
Privacy Masking	2 zones
Gain Control	Low / Middle / High / Very High
White Balance	ATW / AWC / Manual / Indoor / Outdoor
Electronic Shutter Speed	1/30 ~ 1/12,000sec(N), 1/25~ 1/12,000sec(P)
Video Rotation	H-Rev/V-Rev
Analytics	Motion detection
IR Viewable Length	25m(82.02ft)
Coaxial Protocol	ACP(AHD Coax Protocol), CVBS: Pelco-C(Coaxitron)
Environmental & Electrical	
Operating Temperature / Humidity	-30°C ~ +55°C (-22°F ~ +131°F) / Less than 90% RH * Start up should be done at above -10°C
Certification	IP66, IK10
Input Voltage	12VDC
Power Consumption	Max 5W
Mechanical	
Color / Material	Dark Gray / Aluminum
Product dimensions / weight	Ø70.0 x 246.0mm(Ø2.76"x9.69"), 670g(1.48 lb)

- The latest product information / specification can be found at hanwha-security.com
- Design and specifications are subject to change without notice.
- Wisenet is the proprietary brand of Hanwha Techwin, formerly known as Samsung Techwin.

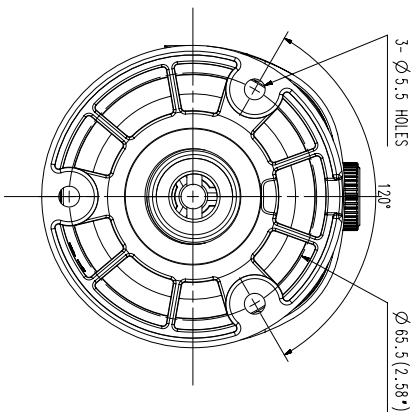
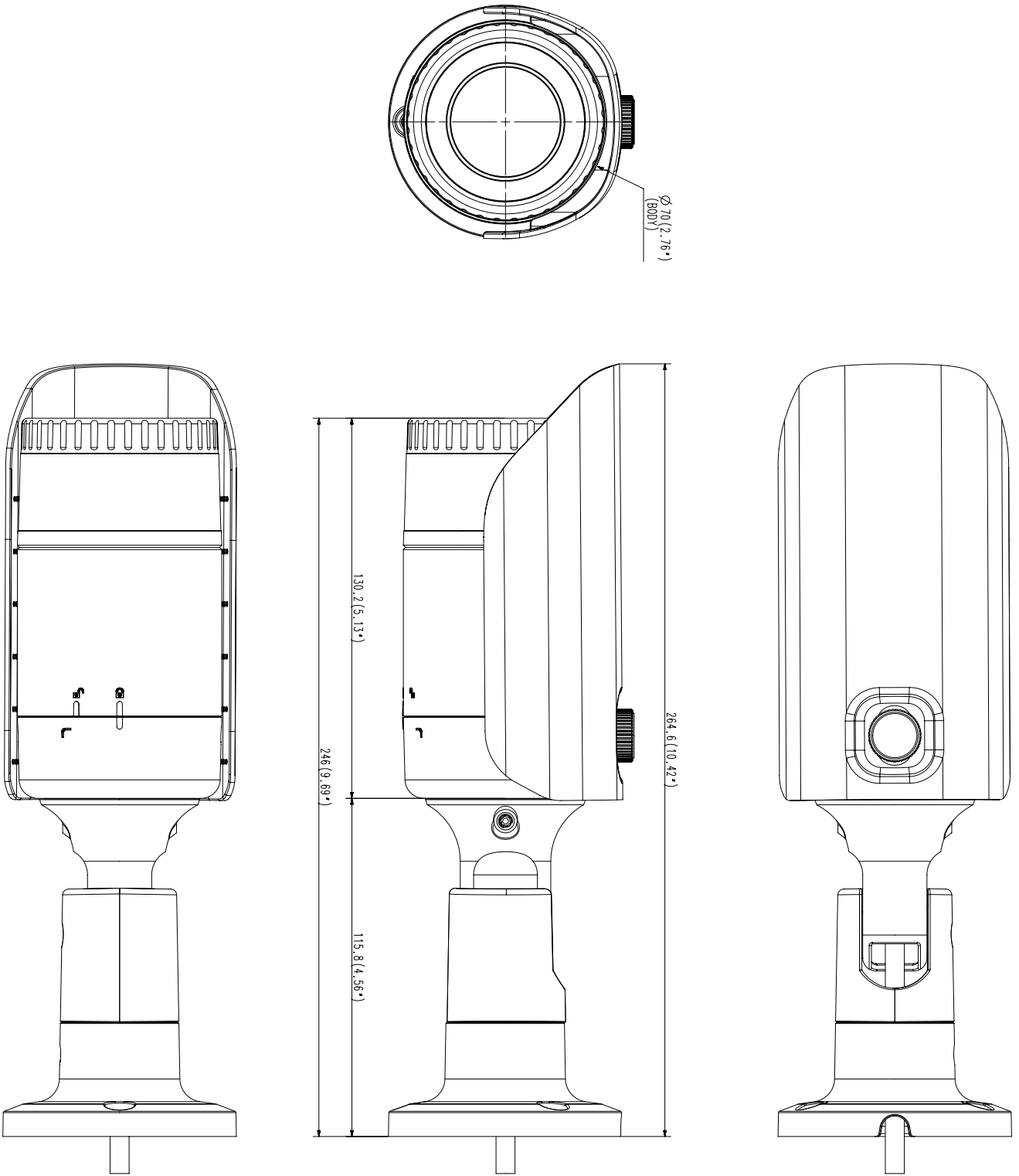

UNIT (inch)	MM	DESIGN	CHECK	APPROVAL	PART NAME
SCALE 1 / 1	HTW	-	-	-	-
17.07.26	17.07.26	17.07.26	17.07.26	17.07.26	HC0-7010R/7020R/7030R
Hanwha Techwin					CODE NO. 049964