

DS-2CD6412FWD-XX 1.3MP Covert Network Camera



Key Features:

- 1/3" Progressive Scan CMOS
- Up to 1280 × 960@30fps for real-time output
- IR cut filter with auto switch
- True WDR, up to 120dB
- PoE power supply is supportable
- Built-in Micro SD / SDHC / SDXC card slot, up to 128GB
- Support HLC, Defog and EIS
- Optional appearance of the front-end(the mini bullet and block) and brackets

DS-2CD6412FWD-XX is covert camera for ATM surveillance, key features including:

Single or dual lens camera body is optional, cylindrical, L-shaped and tube shape of lens are optional;

2m or 8m (between lens and camera body) cable is optional for flexible installation

DS-2CD6412FWD-XX HD resolution with up to 30fps for real-time output;

Rotate mode, BLC, True WDR are for different environment.



DS-2CD6412FWD-XX

1.3MP Separated Network Camera

Specification

Camera	
Image Sensor	1/3" Progressive Scan CMOS
Min. Illumination	-L10/L20/10/20: Color: 0.037 Lux @(F2.3,AGC ON); B/W: 0.0037Lux @(F2.3,AGC ON) -L30/30: Color: 0.028 Lux @(F2.0,AGC ON); B/W: 0.0028Lux @(F2.0,AGC ON)
Shutter Speed	1s ~ 1/100,000s
Slow Shutter	Support
Lens	-L10/L20/10/20: 2.8/3.7mm@ F2.3, angle of view: 80°/57° -L30/30: 2.0/2.8/4/6 mm@ F2.0, angle of view: 120°(2.0mm),92°(2.8mm),73° (4mm),46°(6mm)
Lens Mount	M12
Day & Night	Electronic
WDR	120dB
DNR	3D Digital Noise Reduction
Number of lenses	-C1: Camera body with single lens -C2: Camera body with dual lens
Length of Lens Cable	Optional 2m or 8m
Compression Standard	
Video Compression	H.264/MJPEG4/MPEG
H.264 Type	Baseline Profile / Main Profile / High Profile
Video Bit Rate	32 Kbps – 16 Mbps
Audio Compression	G.711/G.722.1/G.726/MP2L2
Audio Bit Rate	64Kbps(G.711) / 16Kbps(G.726) /64Kbps(MP2L2)
Image	
Max. Resolution	1280 × 960
Frame Rate	50Hz: 25fps (1280 × 960, 1280 × 720) 60Hz: 30fps (1280 × 960, 1280 × 720)
Third stream	Only single channel camera supports third stream, which is independent with main stream, up to 50Hz: 25fps (1280 × 960); 60Hz: 30fps (1280 × 960)
Image Setting	Rotate mode(first channel), saturation, brightness, contrast, sharpness and gray scale adjustable
BLC	Yes, zone optional
Defog	Support
EIS	Support(First channel)
Highlight Compensation	Support
Day / Night mode	Auto / Timing / Alarm trigger
Image Overlay	Support 128 × 128 size BMP with 24-bit depth image overlay, zone optional
ROI	Up to 4 fixed areas in each stream

Dimensions

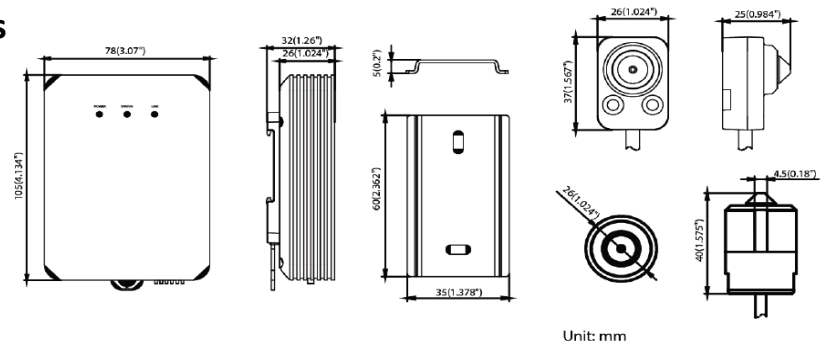

Unit: mm

Network	
Network Storage	Support Micro SD/SDHC/SDXC slot, up to 128GB, Edge recording, NAS (NFS, SMB/CIFS)
Alarm Trigger	Model with single lens: Intrusion detection, audio exception detection, defocus detection All models: motion detection, face detection, dynamic analysis, tampering alarm, network disconnect, IP address conflicts, storage full, storage error
Protocols	TCP/IP, ICMP, HTTP, HTTPS, FTP, DHCP, DNS, DDNS, RTP, RTSP, RTCP, PPPoE, NTP, UPnP, SMTP, SNMP, IGMP, 802.1X, QoS, IPv6, Bonjour
Standard	ONVIF (PROFILE S, PROFILE G), PSIA, CGI, ISAPI
General	Reset, flickerless, multi-stream, heartbeat, rotate, password protection, video masking, watermark, anonymous login, IP address filtering
Interface	
Communication	1 RJ45 10M/100M Ethernet interface/ 1 RS232/ 1 RS-485
Audio Interface	1 3.5mm audio in (Mic in/Line in)/out interface
Alarm Input	1
Alarm Output	1
General	
Working temperature and humidity	-30 °C – 60 °C (-22 °F – 140 °F) Humidity 95% or less (non-condensing)
Power Supply	12 VDC ± 10% / PoE (802.3af)
Power Consumption	Max. 8.26 W
Dimensions	78×105×32 mm (3.07" × 4.13" × 1.26")
Shipping Weight	2m cable: <570g 8m cable: <680g
Net Weight	Main body: 210g Cylindrical lens: 113g(2m), 233g(8m) L-shaped lens: 99g(2m), 220g(8m) Tube lens: 129g(2m), 242g(8m) Package + accessories: 224g

Order Models: (Different accessories included for each sensor unit)

- DS-2CD6412FWD-10: camera body with one cylindrical lens
- DS-2CD6412FWD-20: camera body with one L-shaped lens
- DS-2CD6412FWD-30: camera body with one Tube lens
- DS-2CD6412FWD-11: camera body with dual cylindrical lens
- DS-2CD6412FWD-21: camera body with one cylindrical & one L-shaped lens
- DS-2CD6412FWD-31: camera body with one cylindrical & one Tube lens
- DS-2CD6412FWD-L10: one cylindrical lens with connecting cable
- DS-2CD6412FWD-L20: one L-shaped lens with connecting cable
- DS-2CD6412FWD-L30: one Tube lens with connecting cable
- DS-2CD6412FWD-C1: Camera body with one interface of lens
- DS-2CD6412FWD-C2: Camera body with two interfaces of lens



L10

L20

L30