



Suprema

BIOMETRICS & SECURITY



WHY SUPREMA?



The World's Best Performing Fingerprint Algorithm

Suprema's fingerprint recognition algorithm has proven its superior performance by winning multiple awards and serves as a backbone for numerous fingerprint recognition devices. In addition, the advanced fingerprint recognition algorithm has also had its technology validated through obtaining international certifications such as FBI, IQS, STQC, FVC, and NIST MINEX. The algorithm boasts a level of stability far above other algorithms of its kind as well as the fastest authentication speed and the highest level of accuracy in the world.



The World's Most Widely Used Biometrics Technology

Suprema's biometrics technology is widely used in a variety of fields, including physical access control, ID card issuance, FinTech, forensic investigation, and mobile authentication, and is responsible for the security and safety of over one billion people around the world.



Complete Identification Solution Provider

Based on its biometrics technology, Suprema provides comprehensive solutions for identification with an extensive product lineup that encompasses fingerprint/face recognition devices, live scanners, embedded fingerprint recognition modules, and RFID devices.



Product Quality & Reliability

Suprema is committed to providing customers with reliable products of superior quality. We have obtained ISO 9001 and 14001 certifications and have already been recognized for the quality of our production process. We also run the largest biometrics research and production facility in South Korea with the aim of achieving better quality.



Global Brand Awareness

Having been recognized as a global leader in biometrics for more than a decade, Suprema is listed as one of the world's top 50 security companies by A&S, one of the world's most authoritative magazines in the field of security. In addition, Suprema was awarded the Best Product prize and the Innovation Prize at international security exhibitions such as Sweden's Detektor Award, Russia's All-over-IP, and Brazil's ISC Brazil, and we were also named one of the world's top biometrics companies by Forbes, Frost & Sullivan, and Deloitte.



Global Sales Channels

Suprema has more than 1,000 clients in 133 countries, and more than 75% of our sales come from our official distribution channels. To enhance the competitiveness and sales of our global sales partners, Suprema provides systematic product training sessions, webinars, and marketing support through partner programs.



Technology Partnerships

Suprema is building technical partnerships with world-renowned security companies in a wide range of fields to provide customized solutions for the varied environments of our clients. With more than 70 integrated solutions, we are capable of meeting the needs of diverse clients, and we provide our clients with solutions that have the best performance.



End-to-end Solution Provider

Suprema provides comprehensive biometrics-based security solutions. Based on our globally recognized biometrics technology, we blend hardware and software platforms to provide comprehensive security solutions.



Beyond Technology

At present, Suprema has more than 40% of its employees engaged in research and development and invest more than 16% of its sales in R&D each year. Based on years of expertise in biometrics and security, Suprema has acquired over 100 technology patents and constantly endeavors to employ and develop new technologies.



Financial Stability & Growth Rate

Based on our innovative products and technology, Suprema has recorded a phenomenal mean annual growth rate (CAGR) of 38%. Recognized as a global leader in biometrics, Suprema is estimated to have a market capitalization of 350 million dollars (on the KOSDAQ as of 2014), boasting excellent financial stability.

ACCESS CONTROL SOLUTION FOR GENERAL DATA PROTECTION REGULATION (GDPR)

WHAT IS GDPR?

The General Data Protection Regulation (GDPR) is a regulation in EU law on data protection and privacy for all individuals within the European Union (EU) and the European Economic Area (EEA).

Effective from May 25, 2018, GDPR also addresses the export of personal data outside the EU and EEA. The GDPR aims primarily to give control to citizens and residents over their personal data and to simplify the regulatory environment for international business by unifying the regulation within the EU. Fines for offences related to non-compliance with key provisions, will be up to 4% of annual revenue or 20 million Euros, whichever is greater.

HOW SUPREMA CAN HELP YOU TO PREPARE FOR GDPR COMPLIANCE?

When it comes to access control, GDPR requires that organization to implement appropriate technical and regulatory measure to provide security level against certain risk. Suprema's latest access control security solution now provides comprehensive GDPR-compliant features including below.



Secure biometric data protection by templates

Raw images of the fingerprints / faces are never stored in the device or server. All data is stored in templates which encrypted by 128bit AES, 256bit AES, DES/3DES depending on the designated storage location. (i.e. Device, Server and/or Smartcard)



Protection against transactions, malware and data breaches

TCP communication of data within the system is secured with the use of TLS 1.2 (including SSL/HTTPS). This ensures that no sensitive data is compromised during the communication between the devices and the central server.



Physical protection of privacy data on edge devices

All Suprema devices are equipped with a secure tamper feature, which ensures the security of data stored in the devices. If the device is removed from the wall and tampered with, the secure data (biometric templates, User ID, Logs) within the device will automatically be deleted.



Providing proof of compliance

BioStar 2 delivers comprehensive audit logs compliant to GDPR



Personal data protection by 'access on card'

With Access on Card (AoC) technology, Suprema provides system designers with option to store personal data only on smartcards. All personal data and credential is not stored on servers or devices but only on his/her smartcard of own possession.



Management of personal data lifecycle

In accordance with GDPR, Suprema makes it possible in BioStar 2 so that event logs and data stored in the server is automatically deleted after a certain period of time (set by the administrator). This is in line with the 'right to be forgotten' requirement in the GDPR.



Authentication for data access

With the latest update of BioStar 2, Suprema's open-architecture security platform, system administrators can fully customize level of right on access to personal data information according to their organizational requirements.

Visit Suprema website to learn more how we can help you to prepare GDPR compliance.
www.supremainc.com/GDPR

SUPREMA TECHNOLOGIES

Fingerprint Recognition Algorithm

Suprema's sophisticated fingerprint recognition algorithm has acquired international certifications such as FVC and NIST MINEX, and boasts the world's highest accuracy and fastest authentication speed. This algorithm has a false acceptance rate (FAR) of only 0.00001% and can match up to 150,000 people* per second.

* BioStation A2 (when the usage conditions are met)

Live Finger Detection Technology

Suprema's leading-edge live finger detection technology enables you to identify fake fingerprints forged with various materials by comparing and analyzing the irregular fingerprint patterns and characteristics of fake fingerprints and real fingerprints. This live finger detection technology has been created by combining a fake fingerprint detection algorithm with sensor imaging processing technology. Sensor imaging technology identifies fake fingerprints by comparing fingerprint images obtained via infrared light and white light. This technology enables quick and accurate identification of fake fingerprints made with materials such as paper, film, rubber, clay, silicone, and adhesives. The cutting-edge fingerprint sensor applied to Suprema's fingerprint recognition terminal can reduce image distortion and uniformly correct the contrast, which in turn results in enhanced authentication performance as well as more effective detection of various kinds of fake fingerprints.

Open Supervised Device Protocol (OSDP) support

Suprema's terminals and readers support OSDP, a standard RS-485 communication protocol, in order to enhance interoperability between devices. OSDP enables you to use Suprema's card readers and biometrics terminals by connecting them to third-party control panels and security systems without additional system integration or system development. In addition, with its encrypted bi-directional communication, it also provides enhanced security features and enables you to design more flexible systems.

Face Recognition Technology

Suprema's face recognition technology bases itself on our own proprietary patented adaptive IR technology. This technology boasts the levels of speed and accuracy that far exceed those of any existing facial recognition method. It provides fast and accurate face recognition at any level of brightness, and it also provides live face detection, making it ideal for environments that require a high level of security. Suprema's face recognition terminal has a false acceptance rate (FAR) of only 0.00002% and can match up to 3,000* people per second.

* FaceStation 2 (when the usage conditions are met)

Face Detection

Suprema's access control terminal with a built-in high-definition camera detects the user's face upon their authentication attempt and then performs authentication. It can save the circumstances in which authentication has been performed as an image log. Authentication based on face detection technology provides an efficient type of audit trail as well as enhanced security.

Live Face Detection Technology

Live face detection technology applied to Suprema's face recognition terminal detects forged faces using advanced analysis algorithms. This technology identifies forged faces through combining information, such as the curves, skin tone, and skin quality of the user's face, which is acquired using the IR LED built into the face recognition terminal.

Power over Ethernet (PoE)

Suprema's IP terminal performs both stable power delivery and data transmission at once via an Ethernet cable. Its PoE* feature eliminates the need for extra wiring and therefore enables you to build a system with ease at low installation cost.

* IEEE 802.3af compliant

Distributed System

In distributed systems, IP terminal and readers perform the roles of a controller and reader simultaneously. Therefore, you can undertake functions such as user management, access control management, and biometrics with a single terminal. Suprema's IP terminals and readers improve system reliability with easy system configuration and distributed management. It also provides the benefits of simple wiring and low installation/maintenance costs.

Centralized System

With Suprema's CoreStation and readers, you can build a centralized system, which is a system based on access control units (ACU). Suprema's centralized system not only provides the benefits of biometrics, but it also provides enhanced security and excellent system scalability. In addition, the centralized system also enables you to upgrade your existing systems at lower installation cost.

BioStar 2 Platform

BioStar 2 is a web-based security platform that provides comprehensive functionality for access control and time & attendance. Featuring a modular, flexible framework, the platform supports both the BioStar 2 Device SDK, which is used to integrate Suprema's terminals with third-party systems and web APIs that are used to integrate the functionality of the BioStar 2 platform with third-party systems. In addition, in step with the mobile era, the mobile app for BioStar 2 has been designed to enable you not only to remotely control the BioStar 2 platform but also to get a mobile card issued to you for use.



Time & Attendance Management License				
Item	Starter (free of charge)	Standard	Advanced	Professional
No. of Users	100	500	1,000	Unlimited

Video Log License		
Item	Starter (free of charge)	Video License
Video Logs	-	v

Visitor License		
Item	Starter (free of charge)	Visitor License
Visitor Management	-	v

Access Control License							
Item		Starter (free of charge)	Basic	Standard	Advanced	Professional	Enterprise
Access Control	No. of Doors	5	20	50	100	300	1,000
	Maximum No. of Connected Devices	1,000	1,000	1,000	1,000	1,000	1,000
	Maximum No. of Access Levels ¹⁾	2,048	2,048	2,048	2,048	2,048	2,048
	Maximum No. of Access Groups ¹⁾	2,048	2,048	2,048	2,048	2,048	2,048
	Maximum No. of Access Groups per User	16	16	16	16	16	16
	Maximum No of Access Levels per Access Group	128	128	128	128	128	128
	Access Group Auto Sync	v	v	v	v	v	v
Users	Maximum No. of Cards per User	8	8	8	8	8	8
	Maximum No. of Fingerprints per User	10	10	10	10	10	10
	User Auto Sync	v	v	v	v	v	v
	Access-on-Card	v	v	v	v	v	v
	Security Credential Cards	v	v	v	v	v	v
	iCLASS Seos Card	v	v	v	v	v	v
	Inactivation User Reports	v	v	v	v	v	v
Custom Field	v	v	v	v	v	v	
Elevator Control	Elevators	-	-	-	v	v	v
	Maximum No. of Floors per Elevator	-	-	-	192	192	192
	Maximum No. of Floor Levels	-	-	-	128	128	128
Zones	Anti-Passback	Δ(Door)	Δ(Door)	v	v	v	v
	Fire Alarm	-	-	v	v	v	v
	Schedule Lock/Unlock	-	-	v	v	v	v
	Intrusion Alarm Zone	-	-	v	v	v	v
	Interlock Zone	-	-	v	v	v	v
	Muster Zone	-	-	v	v	v	v
Advanced Features	Dashboard	v	v	v	v	v	v
	Cloud	-	-	v	v	v	v
	Server Matching	-	-	-	v	v	v
	Audit Trail	v	v	v	v	v	v
	Daylight Saving Time	v	v	v	v	v	v
	Dual Authentication	v	v	v	v	v	v
Monitoring	Graphic Map	-	-	-	v	v	v

¹⁾ Available from BioStar 2.7.0. (Requires latest firmware)

BioStar 2 AC | Access Control

You can use the advanced access control features of the BioStar 2 access control module by purchasing a license. With the purchase of a license, in addition to BioStar 2's basic license features, you can also use elevator control, advanced anti-passback zone control, fire alarm zone, scheduled lock/unlock zone, intrusion alarm zone, server matching, and video log features. Moreover, because you can use both distributed and centralized access control system configurations, you can provide your clients with optimal access control systems that can accommodate various environments and customer needs.



Customized System Architecture



Elevator Control



Improved Zone Management



Server Matching



Video Logs



BioStar 2 TA | Time & Attendance

You can use the BioStar 2 time & attendance module when you intend to build a more flexible time & attendance system by purchasing a license. In addition to BioStar 2's basic license features, the BioStar 2 time & attendance module also provides features that enable you to set an unlimited number of schedules and specify the number of users for each schedule. Therefore, the BioStar 2 time & attendance module is ideal for when you want to build an enterprise-class system or create a variety of time & attendance rules.



Setting Various Shifts



Convenient Overtime Setting



Easy Shift Type Setting







Timesheet Calendar View



BioStar 2 Mobile









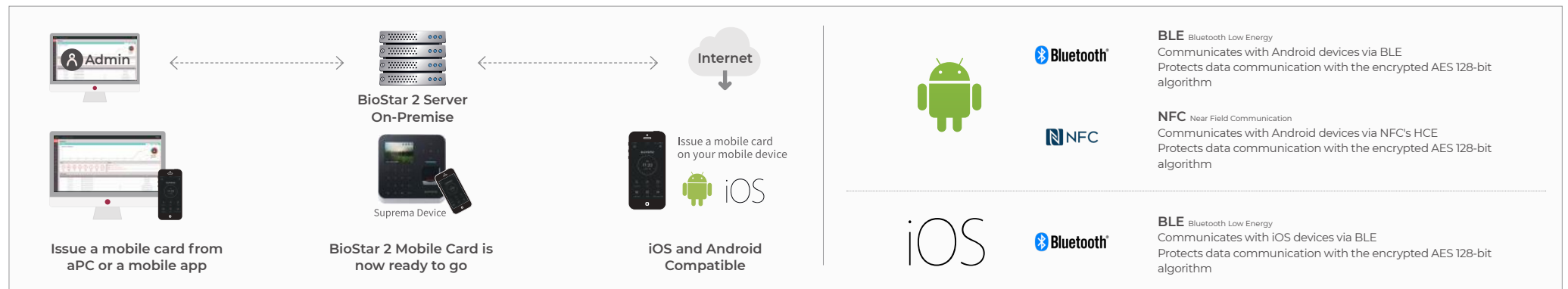

BioStar 2 Mobile enables you to freely control BioStar 2 anywhere, at any time on your smart device. Developed based on BioStar 2's web APIs, BioStar 2 Mobile provides services appropriate for the mobile era, including user information registration, BioMini-based fingerprint registration, door control, real-time door and zone status notification, and access control event monitoring. In addition, mobile cards, which you can issue via BioStar 2, are an authentication means capable of completely replacing existing plastic cards, and they help you build the most convenient and innovative mobile access control solutions.



- 
Remote User Registration
- 
Remote Door Control
- 
Real-time Door and Zone Status Notification
- 
Access Control Event Monitoring
- 
Mobile Cards

BioStar 2 Mobile Card



- | Supported Products | FaceStation 2 | FaceLite | BioStation A2 | BioStation 2 | BioStation L2 | BioLite N2 | BioEntry W2 | BioEntry P2 | BioEntry R2 | XPass D2 / XPass 2 |
|--------------------|---|---|---|---|---|---|---|---|---|---|
| |  |  |  |  |  |  |  |  |  |  |
| | Bluetooth NFC | Bluetooth NFC | NFC | NFC | NFC | Bluetooth NFC | NFC | NFC | NFC | Bluetooth NFC |

BioStar 2 Device SDK

The BioStar 2 Device SDK is a development tool that enables you to control the core features of Suprema's terminal through third-party software. This development framework can be applied to both Suprema's access control and time & attendance terminals, and it opens up unlimited possibilities for building powerful access control and time & attendance solutions.

Builds Powerful Solutions

The BioStar 2 Device SDK enables you to control the powerful functions provided by Suprema's terminal through your existing management software. The BioStar 2 Device SDK enables you to manage access control, time & attendance, and device settings with ease as well as to build solutions that suit your needs.

Various Programming Languages and OS Supported

The BioStar 2 Device SDK supports C++ and C#, two of the most widely used programming languages in the world, and it also supports Windows operating systems.

Standalone Data Architecture and API

With the BioStar 2 Device SDK, you can develop software using concise code instead of complex branching statements. In addition, because the property information of each device is provided as a single architecture, you do not have to modify the UIs or logic of your existing applications even when a new device has been added.

BioStar 2 API

The BioStar 2 API is a Web API that enables you to integrate the core features of BioStar 2 with third-party software as well as to control them. It is the perfect tool that enables you to develop mobile access control applications based on BioStar 2's powerful features.

The Perfect Tool for Development

You can use the BioStar 2 API to integrate BioStar 2 with existing security solutions as well as to develop new security solutions.

Provides Optimized Development Environments

The standardized BioStar 2 API enables you to directly communicate with BioStar 2 using REST and JSON without going through the SDK of your device. This makes it easy to integrate with other web-based solutions and enables you to develop apps in Android and iOS as well.

Open Source

With the exception of the access control feature, which is one of BioStar 2's core features, all supplementary features are provided as modular applications. Because most of the applications have been developed using the BioStar 2 API, they can be used as open source software, thereby creating new value or increasing platform scalability.

Centralized System | Access Control and Time & Attendance

With Suprema's CoreStation and readers, you can build a centralized system, which is a system based on access control units (ACU). Suprema's centralized system not only provides the benefits of biometrics, but it also provides enhanced security and excellent system scalability. In addition, the centralized system also enables you to upgrade your existing systems at lower installation cost. Integrated with BioStar 2, this system safely stores all information about each user including the user's name, ID, PIN, access rights and fingerprint data by storing it on a single device. Suprema's intelligent biometric controller, CoreStation, is capable of performing fingerprint matching as well as RFID cards. It provides differentiated performance and features based on a 4-channel module that boasts superior hardware performance and scalability.



Biometrics-Based System



Enterprise-Class Performance



Outstanding Scalability



Improved Security



Low Installation and Maintenance Costs

Performance of a CoreStation, Not Just a Number

- Performs 400,000 match/sec
- Controls up to 132 Wiegand devices (DM-20 connection required)
- Stores up to 500,000 users and RFID cards
- Controls up to 64 RS-485 devices
- Stores up to 5,000,000 text logs
- Processes fingerprint authentication on up to 8 devices simultaneously within 1 second

CoreStation Specs	
CPU	1.4 GHz Octa Core
Memory	8 GB Flash + 1 GB RAM
Max. Users	500,000 (1:1) and 100,000 (1:N)
Max. Templates	1,000,000 (1:1) and 200,000 (1:N)*
Max. Text Logs	5,000,000 (text)
Serial Communication Protocol	OSDP V2
Ethernet	10/100 Mbps and Auto MDI/MDI-X
RS-485	5ch
Wiegand	4ch Input
Relay	4 Relays
TTL Input	8ch (Supervised input selectable)
TTL Output	8ch
AUX Input	2ch (AC power fail and tamper)

* Two templates per finger

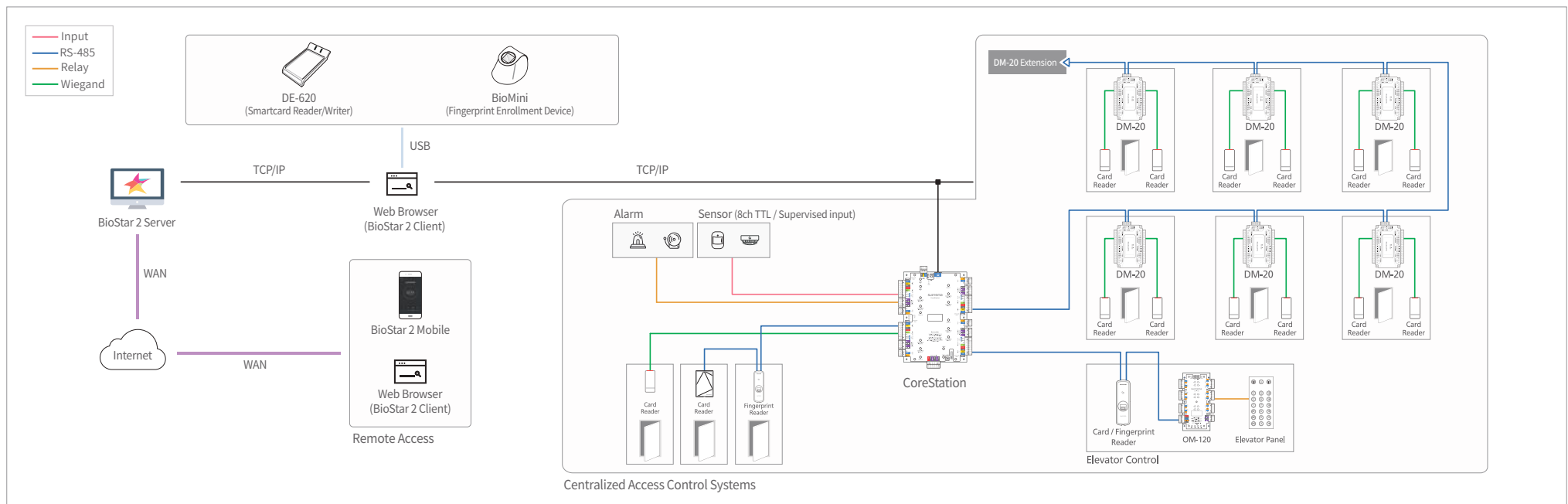



Supported Products



Intelligent Biometric Controller
CoreStation



Compact Fingerprint Reader
BioEntry R2



Outdoor Compact RFID Reader
XPass D2

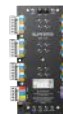

Secure Multi-output Module
OM-120



Secure Multi-door I/O Module
DM-20

Accessory



Dedicated Cabinet
ENCR-10

Distributed System | Access Control and Time & Attendance

In distributed systems, IP terminal and readers perform the roles of a controller and reader simultaneously. Therefore, you can undertake functions such as user management, access control management, and biometrics with a single terminal. Suprema's IP terminals and readers improve system reliability with easy system configuration and distributed management. It also provides the benefits of simple wiring and low installation/maintenance costs.

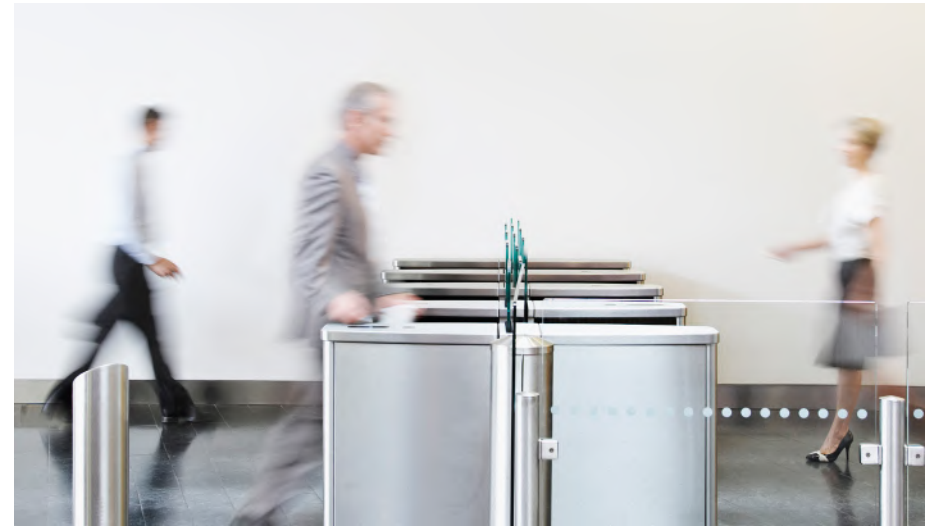



Biometrics-Based System

Easy Installation

Outstanding Scalability

Various Biometrics Devices available

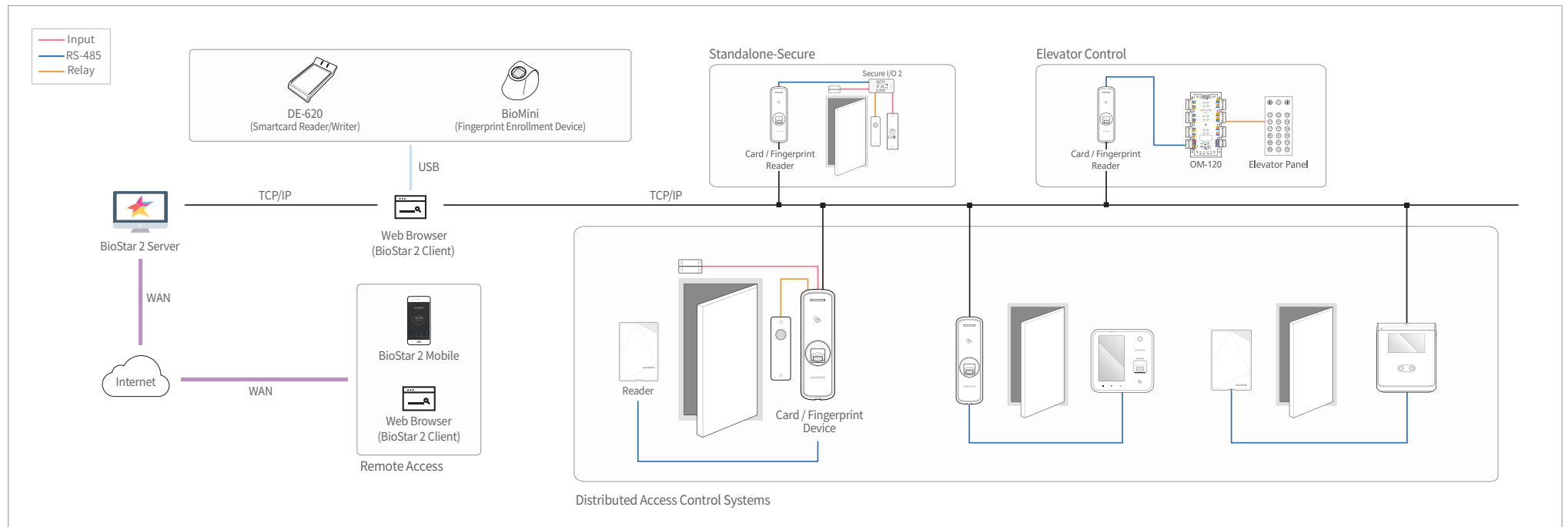
Low Installation and Maintenance Costs





Supported Products



IP Face Recognition Terminal
FaceStation 2



Compact IP Face Recognition Terminal
FaceLite



IP Fingerprint Terminal
BioStation A2



Outdoor IP Fingerprint Terminal
BioStation 2



IP Fingerprint Terminal
BioStation L2



Outdoor IP Fingerprint Terminal
BioLite N2



Outdoor IP Fingerprint Device
BioLite Net



Outdoor IP Fingerprint Device
BioEntry W2



Compact IP Fingerprint Device
BioEntry P2



Outdoor Compact RFID Device
XPass 2

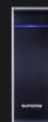

IP RFID Device
Xpass



IP RFID Device
Xpass S2











Secure Door Control Module
Secure I/O 2



Secure Multi Output Module
OM-120

Performance and Specification Comparison

Product						
Product Name		FaceStation 2	FaceLite	BioStation A2	BioStation 2	BioStation L2
General	Biometrics	Face	Face	Fingerprint	Fingerprint	Fingerprint
	LFD (Live Finger Detection)	-	-	Yes	-	Yes
	Protection Class	-	-	-	IP65	-
	RF Options	FS2-D: 125kHz EM & 13.56MHz MIFARE, MIFARE Plus, DESFire/EV1, FeliCa, NFC FS2-AWB: 125kHz EM, MIFARE Plus, HID Prox & 13.56MHz MIFARE, DESFire/EV1, FeliCa, iCLASS SE/SR/Seos, NFC & 2.4GHz BLE	FL-DB: 125kHz EM & 13.56MHz MIFARE, MIFARE Plus, DESFire/EV1, FeliCa, NFC & 2.4GHz BLE	BSA2-OEPW: 125kHz EM BSA2-OHPW: 125kHz HID Prox BSA2-OIPW: 13.56MHz iCLASS SE/SR/Seos, NFC BSA2-OMPW: 13.56MHz MIFARE, MIFARE Plus, DESFire/EV1, FeliCa, NFC	BS2-OEPW: 125kHz EM BS2-OHPW: 125kHz HID Prox BS2-OIPW: 13.56MHz iCLASS SE/SR/Seos, NFC BS2-OMPW: 13.56MHz MIFARE, MIFARE Plus, DESFire/EV1, FeliCa, NFC	BSL2-OE: 125kHz EM BSL2-OM: 13.56MHz MIFARE, MIFARE Plus, DESFire/EV1, FeliCa, NFC
Capacity	Max. Users (1:1)	30,000	30,000	500,000	500,000	500,000
	Max. Users (1:N)	3,000	3,000	100,000	20,000	100,000
	Max. Templates (1:1)	900,000 ⁺	900,000 ⁺	1,000,000*	1,000,000*	1,000,000*
	Max. Templates (1:N)	90,000 ⁺	90,000 ⁺	200,000*	40,000*	200,000*
	Max. Text Logs	5,000,000	5,000,000	5,000,000	3,000,000	1,000,000
	Max. Image Logs	50,000	-	50,000	-	-
Interfaces	Wi-Fi	Yes (Built-in)	-	Yes (Built-in)	Yes (Built-in)	-
	TCP/IP	Yes	Yes	Yes	Yes	Yes
	RS-485	1ch Host or 1ch Slave	1ch Host or 1ch Slave	1ch Host or Slave	1ch Host or Slave	1ch Host or Slave
	Wiegand	1ch In and 1ch Out	1ch In and 1ch Out	1ch In and 1ch Out	1ch In and 1ch Out	1ch In or Out
	I/O	2 Inputs	2 Inputs	2 Inputs	2 Inputs or 2 Outputs	2 Inputs
	Relay	1 Relay	1 Relay	2 Relays	1 Relay	1 Relay
	USB	Host	Host	Host	Host	-
Hardware	CPU	1.4 GHz Quad Core	1.2 GHz Quad Core	1 GHz Quad Core	1.0 GHz	1.2 GHz Quad Core
	Memory	8 GB Flash + 1 GB RAM	8 GB Flash + 1 GB RAM	8 GB Flash + 1 GB RAM	8 GB Flash + 128 MB RAM	2 GB Flash + 256 MB RAM
	Audio	24 bit/Voice DSP (echo cancellation)	24 bit/Voice DSP (echo cancellation)	24 bit/Voice DSP (echo cancellation)	16-bit Hi-Fi	16-bit Hi-Fi
	Operating Temperature	-20°C ~ 50°C	-20°C ~ 50°C	-20°C ~ 50°C	-20°C ~ 50°C	-20°C ~ 50°C
	Tamper	Yes	Yes	Yes	Yes	Yes
	Power	24VDC	24VDC	12VDC	12VDC	12VDC
	PoE	-	-	Yes	Yes	-
	Dimensions (W x H x D mm)	141 x 164 x 125	80 x 160.3 x 71.8	155 x 155 x 40	142 x 145 x 45	71 x 201 x 44
Certifications	CE, FCC, KC, RoHS, REACH, WEEE, BT SIG	CE, FCC, KC, RoHS, REACH, WEEE, BT SIG	CE, FCC, KC, RoHS, REACH, WEEE	CE, FCC, KC, RoHS, REACH, WEEE	CE, FCC, KC, RoHS, REACH, WEEE	

					
BioLite N2	BioEntry W2	BioEntry P2	XPass 2	Xpass	Xpass S2
Fingerprint	Fingerprint	Fingerprint	-	-	-
-	Yes	-	-	-	-
IP67	IP67, IK09	-	IP65, IP67, IK08	IP65	IP65
BLN2-ODB: 125kHz EM & 13.56MHz MIFARE, MIFARE Plus, DESFire/EV1, FeliCa, NFC & 2.4GHz BLE	BEW2-OHP: 125kHz HID Prox	BEP2-OD: 125kHz EM & 13.56MHz MIFARE, MIFARE Plus, DESFire/EV1, FeliCa, NFC	XP2-MDPB, XP2-GDPB, XP2-GKDPB: 125kHz EM & 13.56MHz MIFARE, MIFARE Plus, DESFire/EV1, FeliCa, NFC & 2.4GHz BLE	XPE-PoE: 125kHz EM	XPS2M: 13.56MHz MIFARE, MIFARE Plus, DESFire/EV1 (CSN), FeliCa
BLN2-OAB: 125kHz EM, HID Prox & 13.56MHz MIFARE, MIFARE Plus, DESFire/EV1, FeliCa, iCLASS SE/SR/Seos, NFC & 2.4GHz BLE	BEW2-ODP: 125kHz EM & 13.56MHz MIFARE, MIFARE Plus, DESFire/EV1, FeliCa, NFC	BEP2-OA: MIFARE Plus, DESFire/EV1, 125kHz EM, HID Prox & 13.56MHz MIFARE, FeliCa, iCLASS SE/SR/Seos, NFC		XPM-PoE: 13.56MHz MIFARE, DESFire/EV1 (CSN)	
BLN2-PAB: 125kHz EM, HID Prox & 13.56MHz MIFARE, MIFARE Plus, DESFire/EV1, FeliCa, iCLASS SE/SR, iCLASS Seos, NFC & 2.4GHz BLE	BEW2-OAP: 125kHz EM, MIFARE Plus, HID Prox & 13.56MHz MIFARE, DESFire/EV1, FeliCa, iCLASS SE/SR/Seos, NFC			XPH-PoE: 125kHz HID Prox	
10,000	500,000	10,000	200,000	40,000	50,000
10,000	100,000	10,000	200,000	40,000	50,000
20,000*	1,000,000*	20,000*	-	-	-
20,000*	200,000*	20,000*	-	-	-
1,000,000	1,000,000	1,000,000	1,000,000	50,000	100,000
-	-	-	-	-	-
-	-	-	-	-	-
Yes	Yes	Yes	Yes	Yes	Yes
1ch Host or Slave	1ch Host or Slave	1ch Host or Slave	1ch Master or Slave	1ch Host or Slave	1ch Host or Slave
1ch In or Out	1ch In or Out	1ch In or Out	1ch In or Out	1ch In or Out	1ch In or Out
2 Inputs	2 Inputs	2 Inputs	2 Inputs	2 Inputs	2 Inputs
1 Relay	1 Relay	1 Relay	1 Relay	1 Relay	1 Relay
-	-	-	-	-	-
1.2 GHz	1.2 GHz Quad Core	1.0 GHz	1.0 GHz	533 MHz DSP	533 MHz DSP
4GB Flash + 64MB RAM	2 GB Flash + 256 MB RAM	8 GB Flash + 64 MB RAM	4 GB Flash + 64 MB RAM	8 MB Flash + 16 MB RAM	16 MB Flash + 16 MB RAM
16-bit Hi-Fi	Multi-tone Buzzer	Multi-tone Buzzer	Multi-tone Buzzer	Multi-tone Buzzer	Multi-tone Buzzer
-20°C ~ 50°C	-20°C ~ 50°C	-20°C ~ 50°C	-35°C ~ 65°C	-20°C ~ 50°C	-35°C ~ 65°C
Yes	Yes	Yes	Yes	Yes	Yes
12VDC	12VDC	12VDC	12VDC	12VDC	12VDC
-	Yes	-	Yes	Yes	-
58 x 190 x 44	50 x 172 x 43.5	50 x 164 x 37.5	XP2-MDPB: 48 x 145 x 27 XP2-GDPB/GKDPB: 80 x 130 x 25	45 x 130 x 27	80 x 120 x 11.4
CE, FCC, KC, RoHS, REACH, WEEE	CE, FCC, KC, RoHS, REACH, WEEE, UL 294	CE, FCC, KC, RoHS, REACH, WEEE	CE, FCC, KC, RoHS, REACH, WEEE, SIG	CE, FCC, KC, RoHS, REACH	CE, FCC, KC, RoHS, REACH, WEEE

* Thirty templates per face * Two templates per finger

Suprema Systems UK Ltd

3100 Vyse Terrace, Branston Court Business Centre,
Branston Street, Jewellery Quarter, Birmingham B18 6BA

T +44 800 368 8123
E sales_uk@supremainc.com

Suprema America LLC

250 International Pkwy, Suite 134 Lake Mary, FL 32746

T +1 (800) 490-6971
E sales_na@supremainc.com

Suprema Systems Germany GmbH

Königsallee 14, 40212 Düsseldorf

T +49 211-13 86 62 63
E sales_eu@supremainc.com

Suprema Brazil

E sales_br@supremainc.com

Suprema France SARL

16bis rue Grange Dame Rose,
78140 Vélizy-Villacoublay, France

T +33 78 135 2345
E sales_fr@supremainc.com

Suprema Mexico

E sales_sa@supremainc.com

Suprema Middle East

Dubai Airport Freezone Building 1E, #206
PO Box: 371157

T +971 50 940 5133
E sales_me@supremainc.com

Suprema Japan

105-0004 Tokyo, Minato-ku, Shinbashi,
4 Chome-21-3 #337

T +81 03 6895 7527
E sales_jp@supremainc.com

Suprema Inc.

17F Parkview Tower, 248, Jeongjail-ro, Bundang-gu, Seongnam-si, Gyeonggi-do, 13554, Rep. of KOREA

T +82 31 783 4502 F +82 31 783 4503 E sales_sys@supremainc.com www.supremainc.com

suprema
BIOMETRICS & SECURITY

©2019 Suprema, Inc. Suprema and identifying product names and numbers herein are registered trade marks of Suprema, Inc. All non-Suprema brands and product names are trademarks or registered trademarks of their respective companies. Product appearance, build status and/or specifications are subject to change without notice. [SUPREMA-AMB-LB-EN-REV21]