

REDFSCAN Pro

LONG RANGE INDOOR / OUTDOOR LIDAR SERIES

Extremely reliable and versatile, the REDSCAN PRO security sensors are using LiDAR technology to create a high resolution virtual laser wall or plane up to 100m long, ideal to protect perimeters, buildings, roofs and assets.

Featuring onboard sensing analytics, the LiDAR will detect accurately, even in changing weather and lighting conditions, the size, speed and distance of the moving or loitering objects and track them to the exact X and Y coordinates.

Available Models:

RLS-50100V : 50 x 100 m (approx. 165 x 330 ft.)

RLS-3060V : 30 x 60 m (approx. 100 x 200 ft.)



FOR OUTDOOR AND INDOOR HIGH SECURITY APPLICATIONS

REDSKAN PRO series detects accurately and consistently, without gap, in the near and far.

Precise detection over a large area

The REDSCAN PRO models provide respectively 30x60m (RLS-3060V) and 50x100m (RLS-50100V) detection area, allowing the protection of large areas such as fence line, building façade, open area or roofs/ceilings. Wherever the moving object is located within the detection area, it will be detected with the same accuracy and with right perspective. Variable lighting will not affect the detection.

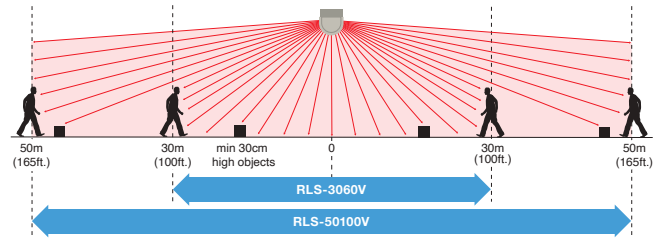

Visual shows the REDSCAN Pro in a vertical mounting

Vertical or horizontal mount is selectable

REDSKAN Pro series can be installed vertically, horizontally or at an angle up to 45°.

Selectable installation method

RLS-3060V and RLV-50100V have 3 installation methods: Wall, Ceiling and Pole mount. You can select the best method to match the installation site.

Vertical detection area

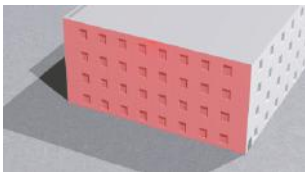

Horizontal detection area

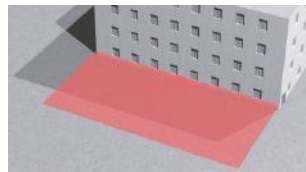

Wall mount

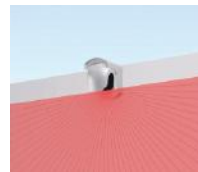

Ceiling mount



Pole mount



Eight independent detection zones

The detection area can be divided in up to 8 independent zones and for each of them the object target size, sensitivity and output can be customised. With this flexibility one sensor can act as multiple sensors and easily adapt to the site's requirements

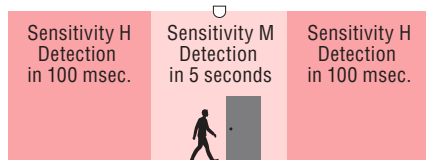

A specific detection zone, such as a door or window can be set at a different sensitivity level.

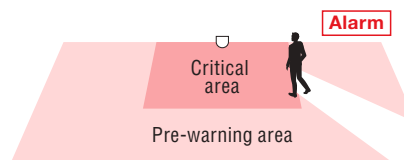

Some detection zones can be set as pre-warning and others as immediate alarm.

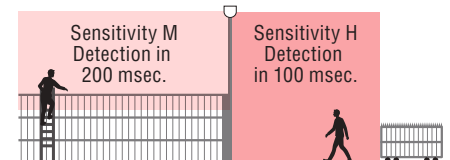

The sensitivity can be adjusted to the assessed risk per zone: high sensitivity to detect a running person and medium for a climbing intruder for instance.

High performance and environmental resistance

Auto area adjustment

Throughout the seasons, changes can happen to the ground or the detection area, with accumulation of leaves or snow. The auto area adjustment allows the REDSCAN Pro unit to continuously adjust the detection area between the object height and revised line of the ground. Adjustment range 1m (3.3ft) as default but can range from 0 to 20m (0 to 65ft).



Small Animal Tolerance

When the REDSCAN PRO is set in vertical mode, there is a Small Animal Tolerance function enabling to ignore small animals moving on the ground.

By default this function is enabled but it could be disabled if there is the requirement to increase the detection sensitivity near to the ground.



Environmental Resistance Function

This function provides additional detection stability during adverse weather conditions such as fog or snow. Different settings are available to adjust the detection algorithm depending on the severity and density of such weather.



Easy installation and configuration

Visualisation of detection area

The REDSCAN Pro series features an assistance camera that provides a laser guide line on the detected area. It allows a quick rough alignment.



Assistance camera (2 MP, Panoramic View)

Built-in angle adjustment function

The built-in bracket within the housing allows a tilt of -5° to 95° . A side adjustment of $\pm 5^{\circ}$ is provided by the software.

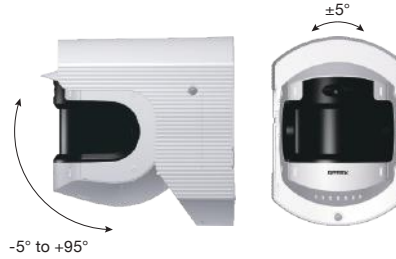

Intuitive Web User Interface

All settings are done via Web Browser, allowing easy and flexible configuration and maintenance.

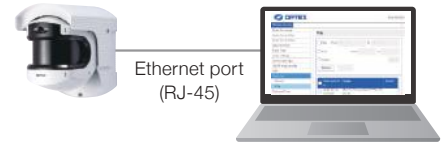

ONVIF (Profile S) compliant



ONVIF is a trademark of Onvif, Inc.
www.onvif.org/profiles/profile-s/

The REDSCAN Pro LiDARs are ONVIF profile S compliant sensors allowing them to send alarm outputs via the ONVIF protocol to any ONVIF compliant networked video system or IP network devices.

Verification of the cause of detection signal

Event log function

The alarm event logs are recorded on the device.

Date and time	Trigger	Result
2019/05/18 04:58:08	MO/A1/AA/CC/DQ/AR/AM/TR/SO/TA	
2019/05/18 20:58:08	MO/A1/AA/CC/DQ/AR/AM/TR/SO/TA	
2019/05/19 07:58:08	MO/A1/AA/CC/DQ/AR/AM/TR/SO/TA	

Assistance camera (2 MP, 170°)

Pre- and post events images are stored with the log for alarm verification and analysis.

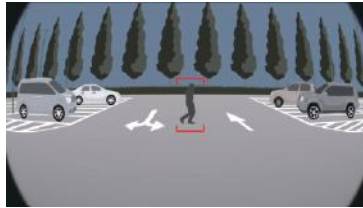

High-capacity memory

Logs and images/videos are saved in the internal memory, up to 500 events can be stored.

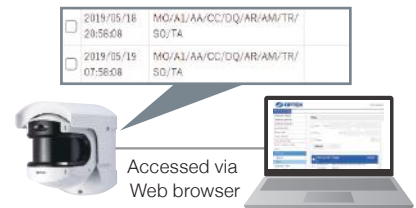

Applications

Through the high resolution, speed of detection and precision of its laser technology, the REDSCAN Pro can protect high security sites against multiple types of intrusion and unauthorised access.

Detect a crawling person



Detect a running person

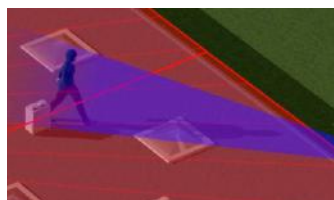

Thrown object detection



Quick intrusion detection

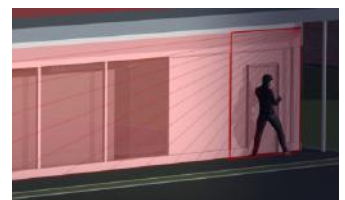

Detection areas

RLS-50100V

- 50 x 100 m (approx. 165 x 330 ft.)
- Very high detection resolution: 0.125°
- Rectangular detection area
- Log function with camera
- Setting by Internet browser

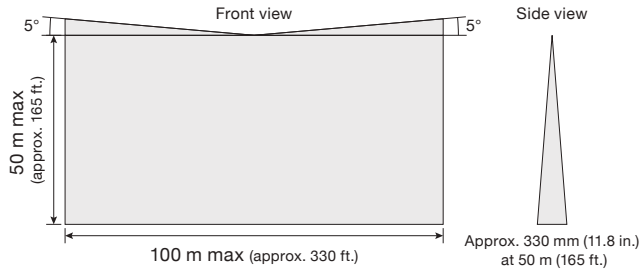

RLS-3060V

- 30 x 60 m (approx. 100 x 200 ft.)
- High detection resolution: 0.25°
- Rectangular detection area
- Log function with camera
- Setting by Internet browser

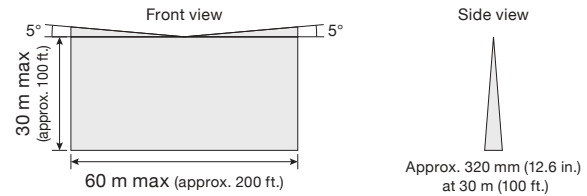

Options

LAC-1	RLS-LWV	RLS-LWVH
Laser Area Checker for all RLS series	Replacement Window for RLS-3060V and RLS-50100V	Replacement Window with heater unit for RLS-3060V and RLS-50100V
		

Dimensions

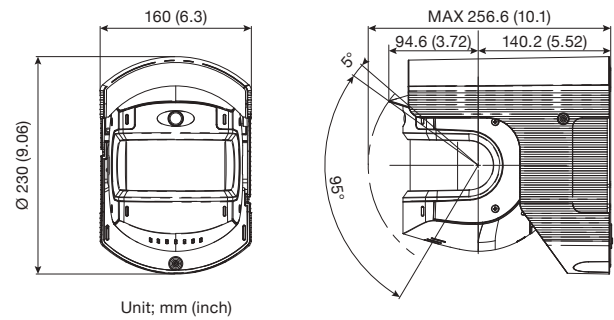

Specifications

Model	RLS-50100V	RLS-3060V
Installation location	Indoor / Outdoor	
Detection method	Infrared Laser Scan	
Laser protection class	Class 1	
Power input	19.2-30 VDC, PoE+ (IEEE 802.3at compliant)	
Current draw	500 mA max. (24 VDC), 12 W max. (PoE+) with heater option: 1.25 A max. (24 VDC), 25.5 W max. (PoE+)	
Mounting method	Ceiling mount, Wall mount, Pole mount	
Detection area	50 x 100 m, 190 degree (approx. 165 x 330 ft.)	30 x 60 m, 190 degree (approx. 100 x 200 ft.)
Detection range	Radius 1 to 50 m (approx. 3.3 to 165 ft.) at 10% reflectivity	Radius 1 to 30 m (approx. 3.3 to 100 ft.) at 10% reflectivity
Detection resolution / Response time	0.125 degrees / within 100 msec. to 15 min.	0.25 degrees / within 100 msec. to 15 min.
Mounting height (Vertical mode)	Indoor: 2 m (approx. 6.7 ft.) or higher/Outdoor: 4 m (approx. 13 ft.) or higher (Recommended)	
Communication port	Ethernet RJ-45 10BASE-T/100BASE-TX (Auto negotiation)	
Protocol	UDP/TCP/HTTP/HTTPS/IPV4/DNS/DHCP/SNMPv1-v3/NTP/WS-Discovery/ONVIF	
Output	6 outputs, 28 VDC 0.2A max. N.O./N.C. Selectable	
Input	1 Non-voltage contact input	
Alarm period	Approx. 2 second delay timer	
Operating temperature	-20°C to 60°C (-4°F to 140°F) with RLS-LWVH: -40 °C to 60°C (-40°F to 140°F)	
Dimensions (H×W×D) , Weight	230 × 160 × 256.6 mm max. (9.1 × 6.3 × 10.1 inch), 2.6 kg (92 oz.)	
IP rating	IP66	



OPTEX CO., LTD. (JAPAN)

www.optex.co.jp/e

OPTEX INC. / AMERICAS HQ (U.S.)
www.optexamerica.com
OPTEX EMEA Security Headquarters
OPTEX (EUROPE) LTD (UK)
OPTEX Security B.V. (Netherlands)
www.optex-europe.com

OPTEX SECURITY SAS (France)
www.optex-europe.com/fr
OPTEX SECURITY Sp.z o.o. (Poland)
www.optex-europe.com/pl
OPTEX/ Fiber Sensys (Middle East)
www.optex-fsi.com
OPTEX PINNACLE INDIA, PVT., LTD. (India)
www.optexpinnacle.com
OPTEX KOREA CO., LTD. (Korea)
www.optexkorea.com

OPTEX (DONGGUAN) CO., LTD.
SHANGHAI OFFICE (China)
www.optexchina.com
OPTEX (Thailand) CO., LTD. (Thailand)
www.optex.co.th