

Detectors

dual technology detectors

KX15DT

INDUSTRIAL / COMMERCIAL / RESIDENTIAL

**Dual Element Blue Wave Technology
Combined PIR and Microwave Detector**



Main Features

- Dual Element Pyro-electric Sensor
- Blue Wave Technology
- Selectable EOL (End of Line) Resistors
- 15m Detection Range
- Patented Independent Floating Thresholds (IFT)
- Adjustable Sensitivity Settings
- Digital Temperature Compensation
- Selectable NO or NC Relay
- Triple LED Indication
- Frequency Options
- X-band DRO Based Microwave
- Sealed Optics
- Tamper Proof Brackets Included
- ABS Plastics

Product Features

Features	Description	Benefits
Selectable EOL Resistors	The KX15DT incorporates selectable alarm resistor values of 6K8, 5K6, 4K7 & 1K & tamper values of 5K6, 4K7, 2K2 and 1K catering for most control panels on the market	Completely eliminates the need for separate resistors, therefore reducing installation time
Blue Wave Technology (BWT)	The very latest technological development from Pyronix	See reverse for more detailed information
Patented Independent Floating Thresholds (IFT)	This technology patented by Pyronix allows the detector to respond to the environmental changes by automatically adjusting its levels of immunity to background disturbances.	Greater stability, reduces risk of false alarm activations
Adjustable Sensitivity Settings	High sensitivity for use in areas where fast detection is required Adjustable sensitivity settings for installations in a more hostile environment	Ensures suitability for most environments
Digital Temperature Compensation	When the product is used in a hot environment this technology digitally adjusts the detector's sensitivity allowing it to regain its range even when the external temperature equals the external body temperature of 32°C	Guarantees optimum performance at all times
Selectable NO or NC relay	The solid state relay can be selected as Normally Open (NO) or Normally Closed (NC) simply by moving the header link supplied	Ideal for switching electrical devices
Triple LED indication	Microwave - orange, PIR - green, alarm - blue	The technology activated can be easily identified
Frequency options	The KX15DT is available in 3 different frequencies	Eliminates the risk of 'cross talk' between detectors located within the same room / environment
X-band DRO based microwave	Metallised microwave housing	Eliminates back lobe radiation
Tamper Proof Brackets	Supplied with both wall and ceiling mount brackets which provides access for up to two 8 core cables. (Tamper kit optional)	Allows ease of installation whilst enhancing tamper protection

Lens Coverage

Supplied

15m Volumetric

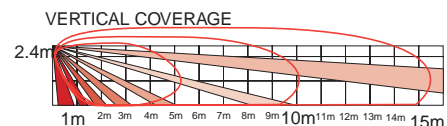
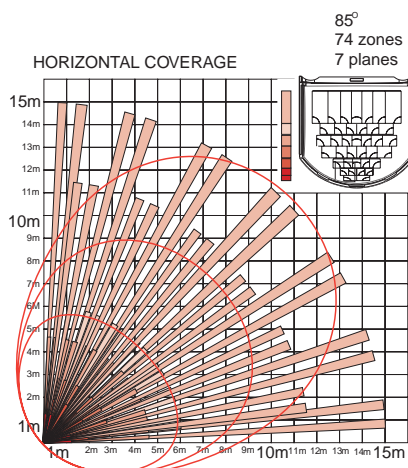

Pyronix Dual Element

The KX15DT has a pyro-electric sensor containing two sensing elements and when projected through a lens form zones as illustrated on the right. In order for an alarm to be triggered two or more of these zones would need to be crossed.

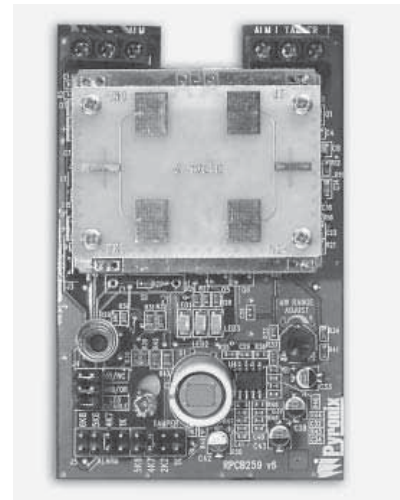

Technical Specifications

ELECTRICAL	
Operating Voltage	9 - 16VDC (12V nominal)
Current Consumption - No Alarm State	23mA
Current Consumption - Alarm State	30mA
Relay	Solid State
Relay Output	60VDC, 50mA, Protected
Tamper Switch	12V max, 50mA max
RFI Immunity to Continuous Wave (CW) 80 - 2000MHz	75V/m
RFI Immunity to Amplitude Modulation (AM) 80 - 2000MHz	25V/m
RFI Immunity to Pulse Modulation (PM) 80 - 2000MHz	25V/m
DTI approved frequencies:	10.680, 10.687, 10.695GHz
FCC approved frequencies:	10.515, 10.525, 10.535GHz
PTT approved frequencies:	9.87, 9.90, 9.91GHz
OPERATING FEATURES	
Alarm period of	2.5 seconds
Detection Speed	0.3 - 3m/s
Operating Temperature	-30°C to +70°C
Storage Temperature	-40°C to +80°C
OPTICAL	
White Light Filter	6500 Lux
Optics	Sealed
Lens	Fresnel array, 'Grooves in' infrared compensated
Protection	Ultraviolet Light Filter
Tilt Adjustment	0° - 12°
MOUNTING	
Optimum Coverage Height	1.8-2.4m

Weights & Dimensions

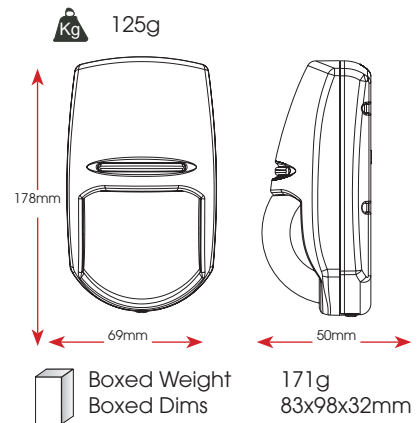

Applications

Features	Applications
AND / OR technology	In high security environments where there is a risk of PIR detection being blocked, the KX15DT's in-built intelligence enables it to switch to microwave detection only. The KX will overcome any cloaking attempts masking IR radiation and software algorithms add MW stability to detect genuine intruder movement.
Blue Wave Technology (BWT)	This further enhances the detector's immunity to infra-red noise in the environment. BWT comprises of 2 key components: 1. The new 3D optics system enables perfect focusing of the infra-red signal onto the pyro-electric sensor. This allows BWT to clearly identify the positive and negative signal edges. 2. Powerful software embedded into a microprocessor is used to process the received information from the pyro-electric sensor. The result of this combination is lower infra-red signal noise amplification and therefore better immunity. 3. A blue LED on the KX digital detectors signifies Blue Wave Technology .

Volumetric

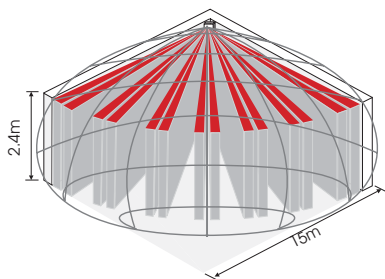

Brackets

Wall Bracket

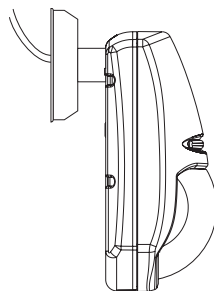

Ceiling Bracket

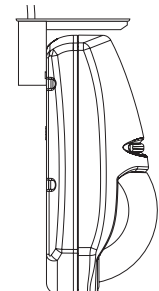

COMPLIANCE	PYRONIX PRODUCT CODE
Europe CE	FPKX15DT
Belgium / Holland INCERT	FPKX15DT2B

PACKING INFORMATION	
Min Pack:	10
Pack Weight:	1.9kg
Accessories:	N/A
Colour:	White
Casing:	3mm ABS Electrostatic Shielded
Warranty:	5 Years
Manufactured:	UK

As part of the continued development programme
specifications may change.

Matrix, PCX, Sterling, Vocaliser, KX, Colt, ME, Magnum, Kudos, Octopus,
Eclipse, Veritec, Break Glass 2000, Twin Alert, Belle and Decibell are all
trade marks of Pyronix Ltd