

WISENET

SÍŤOVÁ KAMERA

Stručná příručka

XND-6080/6080V/6080R/6080RV/8080R/8080RV
XNV-6080/6080R/8080R

CE

KOMPONENT

Příslušenství není pro všechny země prodeje stejné.

- XND-6080/6080R/8080R



- I** Volitelné (není součástí dodávky)



- Nezahmuto : SD kartě

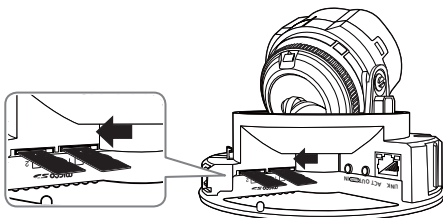

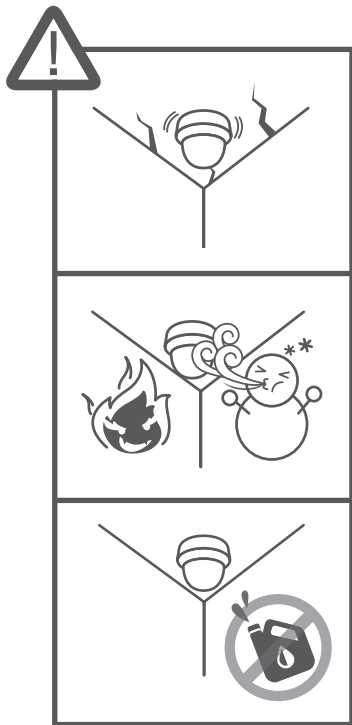

INSTALACE

1-1

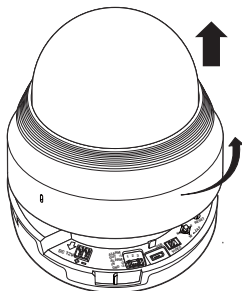

1-2

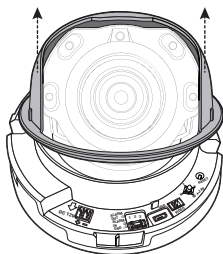

INSTALACE

1-3

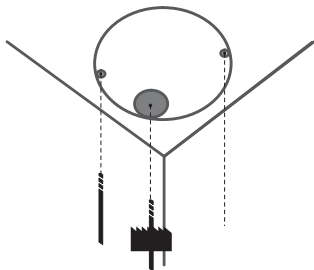

1-4

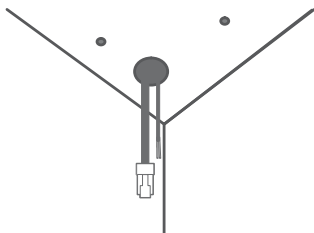

INSTALACE

1-5

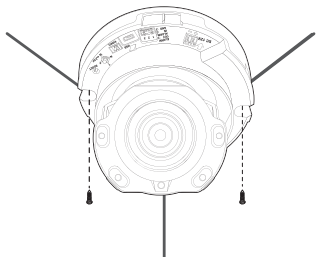

1-6

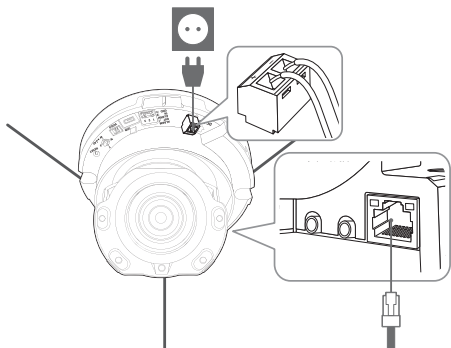

INSTALACE

1-7

- Není součástí balení: klíč WiFi, zařízení OTG

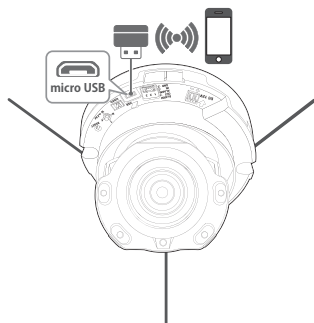

1-8



INSTALACE



1-9

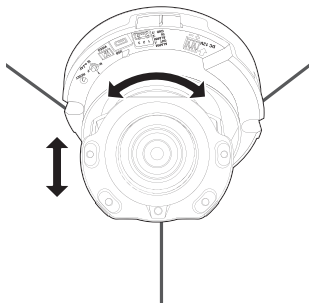

INSTALACE

1-10

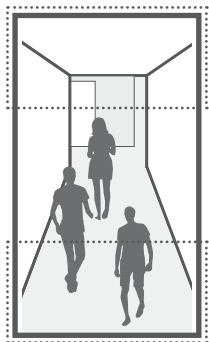
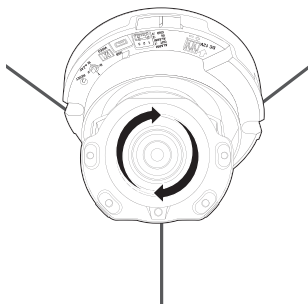

INSTALACE

1-11

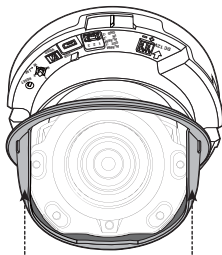

1-12

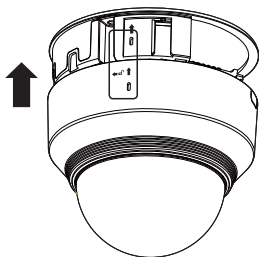



KOMPONENT

Příslušenství není pro všechny země prodeje stejné.

- XND-6080V/6080RV/8080RV



- I** Volitelné (není součástí dodávky)



- Nezahmuto : SD kartě

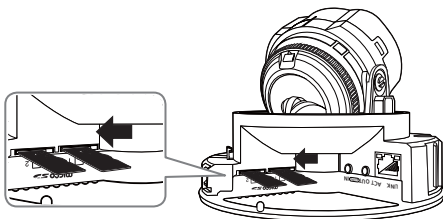

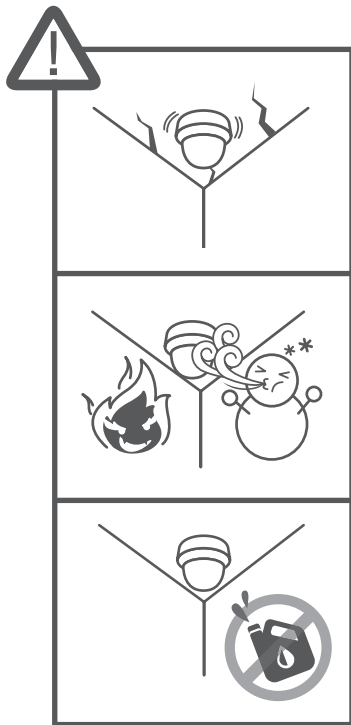

INSTALACE

1-1

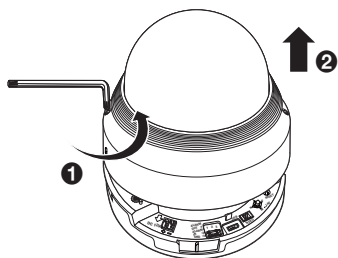

1-2

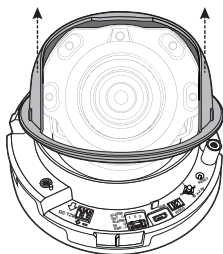

INSTALACE

1-3

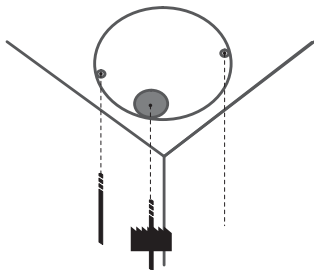

1-4

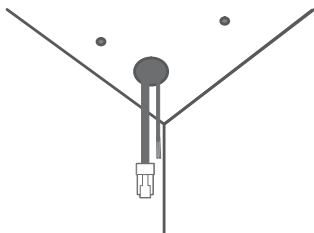

INSTALACE

1-5

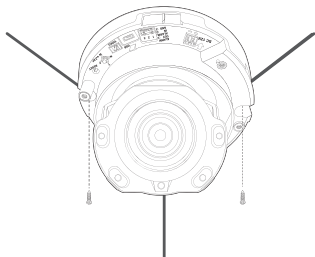

1-6

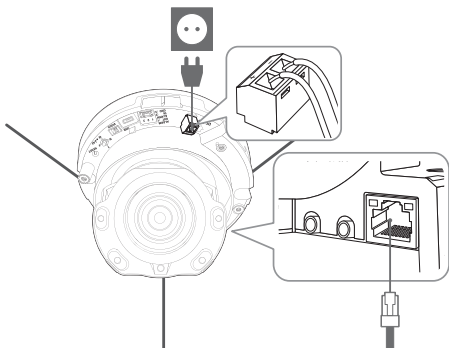

INSTALACE

1-7

- Není součástí balení: klíč WiFi, zařízení OTG

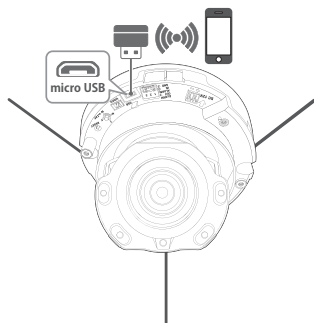

1-8



INSTALACE



1-9

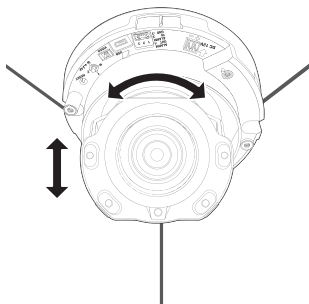

INSTALACE

1-10

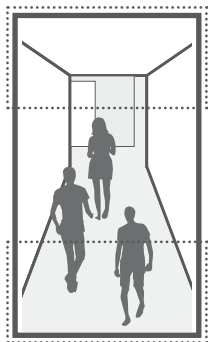
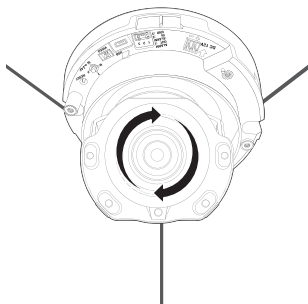

1-11

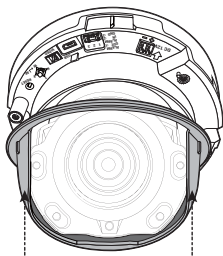

1-12

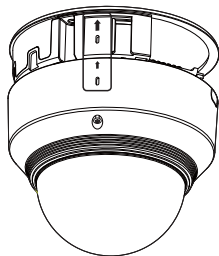

INSTALACE

1-13

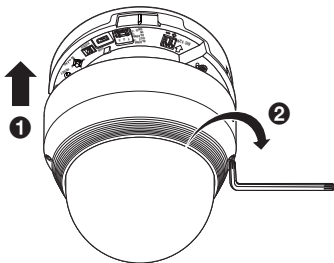

1-14



KOMPONENTY

Příslušenství není pro všechny země prodeje stejné.

- XNV-6080/6080R/8080R

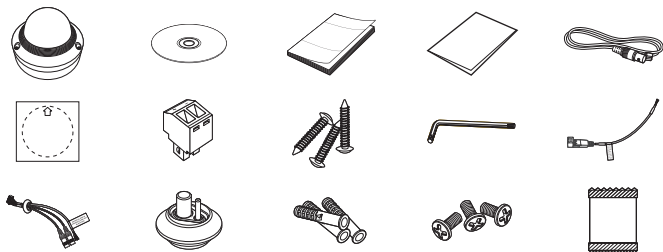

I Volitelné (není součástí dodávky)



- Nezahmuto : SD kartě

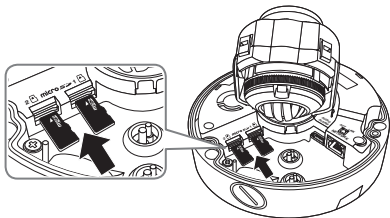

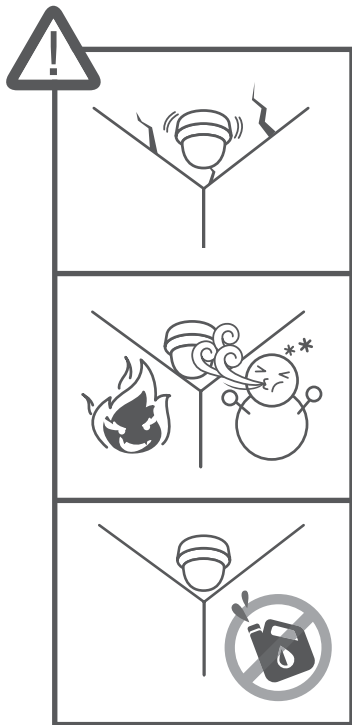

INSTALACE

1-1

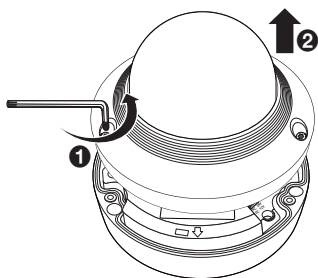

1-2

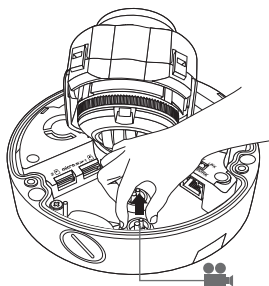

INSTALACE

1-3

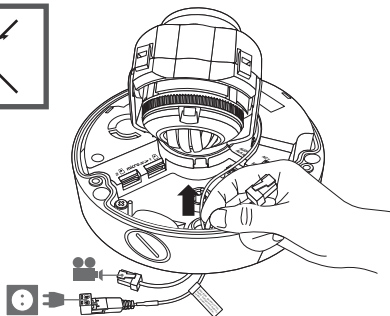
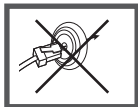
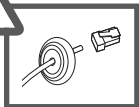

1-4

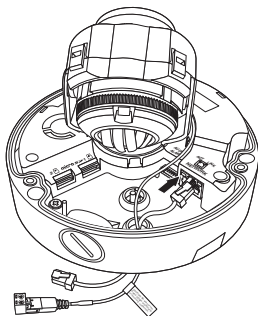

INSTALACE

1-5

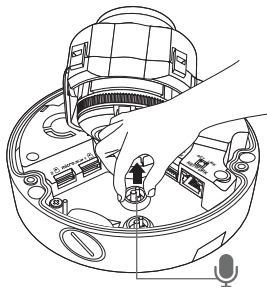

1-6

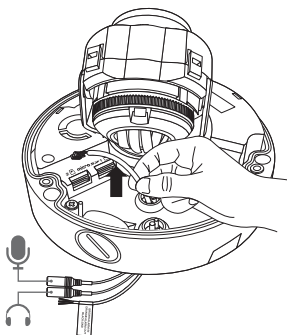

INSTALACE

1-7

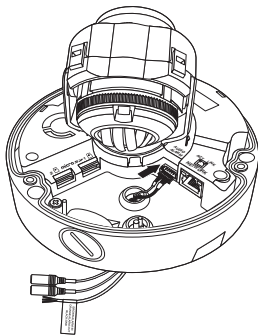

1-8

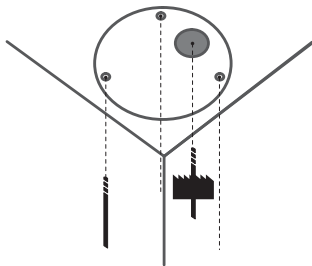

INSTALACE

1-9

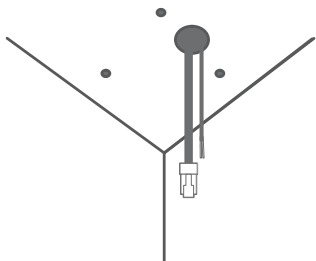

1-10

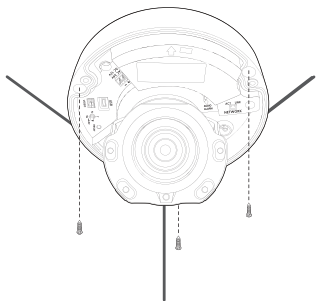

INSTALACE

1-11

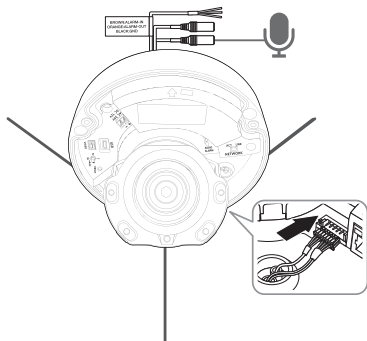

1-12

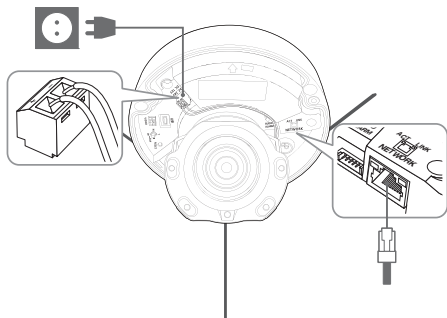

INSTALACE

- 1-13** • Není součástí balení: klíč WiFi, zařízení OTG

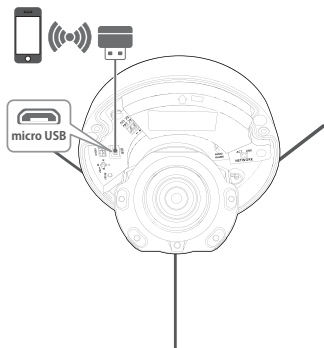

- 1-14**



INSTALACE



1-15

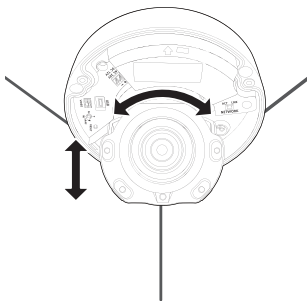
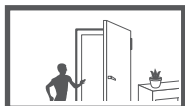

1-16

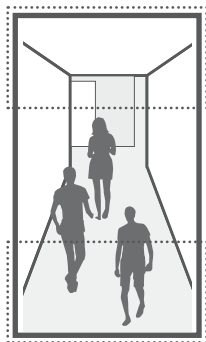
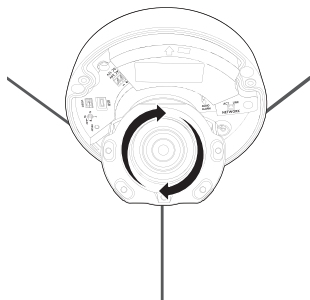

INSTALACE

1-17

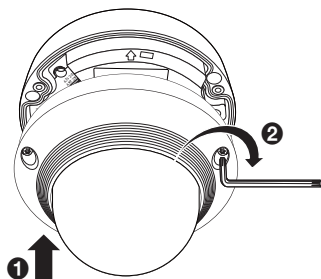

1-18



INSTALACE

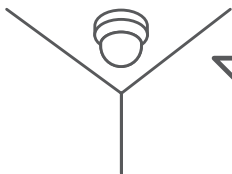
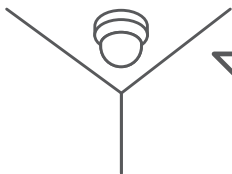

NASTAVENÍ HESLA

Při prvním otevření produktu musíte zaregistrovat přihlašovací heslo.

Když se objeví okno „Změna hesla“, zadejte nové heslo.

Administrator password change

New password

Confirm new password

If the password is 8 to 9 letters long, then it should be a combination of at least three types upper/lower case alphabets, numbers and special characters.
If the password is 10 to 15 letters long, then it should be a combination of at least two types upper/lower case alphabets, numbers and special characters.
User name should be different from password.
The following special characters are available for use: ~!@#%&'()*_-+=[]?.
Don't use 4 or more characters consecutive together. (examples : 1234, abcd)
Don't use 4 or more characters repeated. (examples : 1111, aaaa)



- U nového hesla s 8 nebo 9 znaky musíte použít alespoň 3 z následujících: velká písmena/malá písmena, čísla a speciální znaky. U hesla s 10 až 15 znaky musíte použít alespoň 2 typy z dříve uvedeného.
 - Povolené speciální znaky: ~!@#%&'()*_-+=[]?/?
- Pro vyšší zabezpečení nedoporučujeme při zadávání hesla opakovat stejné znaky nebo po sobě jdoucí klávesy.
- Pokud jste ztratili své heslo, stiskněte tlačítko **[RESET]** a spusťte produkt. Neztratíte tedy své heslo, použijte poznámkový blok nebo si ho zapamatujte.

PŘIHLÁŠENÍ

Při pokusu o přístup ke kameře se zobrazí okno pro přihlášení.

Pro přístup ke kameře zadejte uživatelské jméno a heslo.

- Vepište „admin“ do vstupního pole <User Name>.
- Zadejte heslo do pole <Password>.
- Klepněte na tlačítko **[OK]**.

PŘIPOJOVÁNÍ K WIFI

Nastavení kamery

- Připojte OTG (5 pin) a klíč WiFi k terminálu Micro USB.

Nastavení smartphonu

- Proveďte instalaci instalační aplikace Wisenet.
- Po zapnutí WiFi vyberte SSID kamery.
- Spusťte instalační aplikaci Wisenet.
- Když se přihlásíte ke kameře, video se připojí (původní heslo:4321)
 - Video se bude během původního připojení přehrávat bez přihlášení.
- Pomocí smartphonu lze nastavit úhel kamery.



Společnost Hanwha Techwin dbá při všech fázích výroby na ochranu životního prostředí a přijala řadu opatření k tomu, aby mohla svým zákazníkům dodávat produkty šetrné k životnímu prostředí. Značka Eco je výrazem odhodlání společnosti Hanwha Techwin vyrábět produkty šetrné k životnímu prostředí a znamená, že tento přístroj splňuje požadavky evropské směrnice RoHS.



Správná likvidace tohoto přístroje (Odpad z elektrických a elektronických zařízení)

(Platí v Evropské unii a dalších evropských zemích se systémy děleného sběru odpadu)

Toto označení na přístroji, příslušenství nebo dokumentaci signalizuje, že přístroj a elektronické příslušenství (např. nabíječ, náhlavní souprava, kabel USB) na konci jejich životnosti nepatří do běžného domovního odpadu. Aby se předešlo možnému poškození životního prostředí nebo lidského zdraví, způsobeného nekontrolovanou likvidací odpadu, prosím oddělte tyto položky od jiných typů odpadu a recyklujte je zodpovědně, abyste podpořili udržitelné opětovné použití materiálových zdrojů.

Pro podrobnější informace o tom, kde a jak mohou ekologicky recyklovat tyto položky, by měli domácí uživatelé kontaktovat buď maloobchodníka, u něhož tento produkt koupili, nebo svůj místní úřad.

Podnikoví uživatelé by měli kontaktovat svého dodavatele a zkontrolovat podmínky kupní smlouvy. Tento přístroj a jeho elektronické příslušenství při likvidaci nemíchejte s komerčním odpadem.



Správná likvidace baterií v tomto výrobku

(Platí v Evropské unii a dalších evropských zemích s vlastními systémy zpětného odběru baterií.)

Tato značka na baterii, návodu nebo obalu znamená, že baterie v tomto výrobku nesmí být na konci své životnosti likvidovány společně s jiným domovním odpadem. Případně vyznačené symboly chemikálií Hg, Cd nebo Pb upozorňují na to, že baterie obsahuje rtuť, kadmium nebo olovo v množství překračujícím referenční úroveň stanovené směrnicí ES 2006/66. Pokud baterie nejsou správně zlikvidovány, mohou tyto látky poškodit zdraví osob nebo životní prostředí.

Pro ochranu přírodních zdrojů a pro podporu opakovaného využívání materiálů oddělte, prosím, baterie od ostatních typů odpadu a nechte je recyklovat prostřednictvím místního bezplatného systému zpětného odběru baterií.

Head Office

6, Pangyo-ro 319 beon-gil, Bundang-gu, Seongnam-si,
Gyeonggi-do, 463-400 Rep. of KOREA
Tel : +82.70.7147.8753 Fax : +82.31.8018.3740
<http://hanwha-security.com>

Hanwha Techwin America

500 Frank W. Burr Blvd. Suite 43 Teaneck, NJ 07666
Toll Free : +1.877.213.1222 Direct : +1.201.325.6920
Fax : +1.201.373.0124
www.hanwhasecurity.com

Hanwha Techwin Europe

Heriot House, Heriot Road, Chertsey, Surrey, KT16 9DT, United Kingdom
Tel : +44.1932.57.8100 Fax : +44.1932.57.8101
www.hanwha-security.eu

Hanwha TehchwIn(Tianjin) Co.Ltd

No.11, Weiliu Rd., Micro-Electronic Industrial Park, Jingang Road Tianjin 300385, China
Tel : +86.22.2388.7788
www.hanwha-security.cn

Hanwha Techwin Middle East FZE

JAFZA View 18, 20th floor, office 2001, 2002, 2003, Downtown Jebel Ali,
Dubai, United Arab Emirates
<http://hanwha-security.com>
