

**WISENET**

# **NETWORK CAMERA**

User Manual

PNM-9002VQ  
SLA-2M2400Q/2M2800Q/2M3600Q/  
2M6000Q/5M3700Q/5M4600Q/5M7000Q



# Network Camera

## User Manual

---

### Copyright

©2020 Hanwha Techwin Co., Ltd. All rights reserved.

### Trademark

Each of trademarks herein is registered. The name of this product and other trademarks mentioned in this manual are the registered trademark of their respective company.

### Restriction

Copyright of this document is reserved. Under no circumstances, this document shall be reproduced, distributed or changed, partially or wholly, without formal authorization.

### Disclaimer

Hanwha Techwin makes the best to verify the integrity and correctness of the contents in this document, but no formal guarantee shall be provided. Use of this document and the subsequent results shall be entirely on the user's own responsibility. Hanwha Techwin reserves the right to change the contents of this document without prior notice.

❖ Design and specifications are subject to change without prior notice.

❖ The initial administrator ID is "admin" and the password should be set when logging in for the first time.

Please change your password every three months to safely protect personal information and to prevent the damage of the information theft.

Please, take note that it's a user's responsibility for the security and any other problems caused by mismanaging a password.

## IMPORTANT SAFETY INSTRUCTIONS

1. Read these instructions.
2. Keep these instructions.
3. Heed all warnings.
4. Follow all instructions.
5. Do not use this apparatus near water.
6. Clean the contaminated area on the product surface with a soft, dry cloth or a damp cloth. (Do not use a detergent or cosmetic products that contain alcohol, solvents or surfactants or oil constituents as they may deform or cause damage to the product.)
7. Do not block any ventilation openings, Install in accordance with the manufacturer's instructions.
8. Do not install near any heat sources such as radiators, heat registers, stoves, or other apparatus (including amplifiers) that produce heat.
9. Do not defeat the safety purpose of the polarized or grounding-type plug. A polarized plug has two blades with one wider than the other. A grounding type plug has two blades and a third grounding prong. The wide blade or the third prong are provided for your safety. If the provided plug does not fit into your outlet, consult an electrician for replacement of the obsolete outlet.
10. Protect the power cord from being walked on or pinched particularly at plugs, convenience receptacles, and the point where they exit from the apparatus.
11. Only use attachments/ accessories specified by the manufacturer.
12. Use only with the cart, stand, tripod, bracket, or table specified by the manufacturer, or sold with the apparatus. When a cart is used, use caution when moving the cart/ apparatus combination to avoid injury from tip-over.
13. Unplug this apparatus during lightning storms or when unused for long periods of time.
14. Refer all servicing to qualified service personnel. Servicing is required when the apparatus has been damaged in any way, such as power-supply cord or plug is damaged, liquid has been spilled or objects have fallen into the apparatus, the apparatus has been exposed to rain or moisture, does not operate normally, or has been dropped.
15. This product is intended to be supplied by a Listed Power Supply Unit marked "Class 2" or "LPS" and rated from PoE, 0.45A. (PNM-9002VQ)
16. This Lens module has to be connected with equipment, which supplied by a power supply unit marked "Class 2" or "LPS". (SLA-2M2400Q/2M2800Q/2M3600Q/2M6000Q/5M3700Q/5M4600Q/5M7000Q)
17. This product is intended to be supplied by isolation power.
18. If you use excessive force when installing the product, the camera may be damaged and malfunction. If you forcibly install the product using non-compliant tools, the product may be damaged.
19. Do not install the product in a place where chemical substances or oil mist exists or may be generated. As edible oils such as soybean oil may damage or warp the product, do not install the product in the kitchen or near the kitchen table. This may cause damage to the product.
20. When installing the product, be careful not to allow the surface of the product to be stained with chemical substance. Some chemical solvents such as cleaner or adhesives may cause serious damage to the product's surface.
21. If you install/disassemble the product in a manner that has not been recommended, the production functions/ performance may not be guaranteed. Install the product by referring to "Installation & connection" in the user manual.
22. Installing or using the product in water can cause serious damage to the product.



## WARNING

TO REDUCE THE RISK OF FIRE OR ELECTRIC SHOCK, DO NOT EXPOSE THIS PRODUCT TO RAIN OR MOISTURE. DO NOT INSERT ANY METALLIC OBJECT THROUGH THE VENTILATION GRILLS OR OTHER OPENINGS ON THE EQUIPMENT.

Apparatus shall not be exposed to dripping or splashing and that no objects filled with liquids, such as vases, shall be placed on the apparatus.

To prevent injury, this apparatus must be securely attached to the Wall/ceiling in accordance with the installation instructions.

## CAUTION

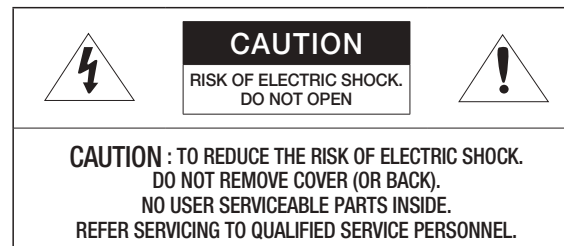

## EXPLANATION OF GRAPHICAL SYMBOLS



The lightning flash with arrowhead symbol, within an equilateral triangle, is intended to alert the user to the presence of "dangerous voltage" within the product's enclosure that may be of sufficient magnitude to constitute a risk of electric shock to persons.



The exclamation point within an equilateral triangle is intended to alert the user to the presence of important operating and maintenance (servicing) instructions in the literature accompanying the product.

## Class I construction

An apparatus with CLASS I construction shall be connected to a MAINS socket outlet with a protective earthing connection.

## Battery

Batteries(battery pack or batteries installed) shall not be exposed to excessive heat such as sunshine, fire or the like.

The battery cannot be replaced.

## Disconnection Device

Disconnect the main plug from the apparatus, if it's defected. And please call a repair man in your location.

**When used outside of the U.S., it may be used HAR code with fittings of an approved agency is employed.**

## CAUTION

RISK OF EXPLOSION IF BATTERY IS REPLACED BY AN INCORRECT TYPE.  
DISPOSE OF USED BATTERIES ACCORDING TO THE INSTRUCTIONS.

## ATTENTION

IL Y A RISQUE D'EXPLOSION SI LA BATTERIE EST REMPLACÉE PAR UNE BATTERIE DE TYPE INCORRECT.  
METTRE AU REBUT LES BATTERIES USAGÉES CONFORMÉMENT AUX INSTRUCTIONS.

These servicing instructions are for use by qualified service personnel only.

To reduce the risk of electric shock do not perform any servicing other than that contained in the operating instructions unless you are qualified to do so.

The Test Monitor Out port of the product is provided for easier installation, and is not recommended for monitoring purposes.

Please use the input power with just one camera and other devices must not be connected.

**The ITE is to be connected only to PoE networks without routing to the outside plant.**

**The wired LAN hub providing power over the Ethernet (PoE) in accordance with IEEE 802.3.af shall be a UL Listed device with the output evaluated as a Limited Power Source as defined in UL60950-1 or PS2 as defined in UL62368-1.**

**Unit is intended for installation in a Network Environment 0 as defined in IEC TR 62102. As such, associated Ethernet wiring shall be limited to inside the building.**

Please read the following recommended safety precautions carefully.

- Do not place this apparatus on an uneven surface.
- Do not install on a surface where it is exposed to direct sunlight, near heating equipment or heavy cold area.
- Do not place this apparatus near conductive material.
- Do not attempt to service this apparatus yourself.
- Do not place a glass of water on the product.
- Do not install near any magnetic sources.
- Do not block any ventilation openings.
- Do not place heavy items on the product.
- Please wear protective gloves when installing/removing the camera.  
The high temperature of the product surface may cause a burn.

User's Manual is a guidance book for how to use the products.

The meaning of the symbols are shown below.

- Reference : In case of providing information for helping of product's usages
- Notice : If there's any possibility to occur any damages for the goods and human caused by not following the instruction

※ Please read this manual for the safety before using of goods and keep it in the safe place.

We do not guarantee the quality of third-party products (e.g. lenses, accessories) that you separately purchase.

# CONTENTS

---

<b>OVERVIEW</b> 3	3	Important Safety Instructions
	6	Recommended PC Specifications
	6	Recommended Micro SD/SDHC/SDXC Memory Card Specifications
	7	What's Included
	8	What's Included (Lens module -optional)
	8	At a Glance
	9	At a Glance (Lens module)

<b>INSTALLATION &amp; CONNECTION</b> 10	10	Installation
	17	Connecting with other Device

<b>NETWORK CONNECTION AND SETUP</b> 18	18	Connecting the Camera Directly to Local Area Networking
	18	Connecting the Camera Directly to a DHCP Based DSL/Cable Modem
	19	Using Device Manager
	19	Automatically searching camera
	19	Configuring IP address
	20	Manually registering camera
	20	Automatically configuring IP
	21	Port Range Forward (Port Mapping) Setup
	22	Connecting to the Camera from a Shared Local PC
22	Connecting to the Camera from a Remote PC via the Internet	

<b>WEB VIEWER</b> 23	23	Connecting to the Camera
	24	Password setting
	24	Login
	24	Camera Web Viewer Setup

<b>APPENDIX</b> 25	25	Troubleshooting
-----------------------	----	-----------------

## RECOMMENDED PC SPECIFICATIONS

---

- CPU : Intel(R) Core(TM) i7 3.4 GHz or higher
  - Supported OS : MS Windows, Mac OS X
  - Recommended browser : Google Chrome
  - Supported browsers : MS Edge, Mozilla Firefox (Windows 64bit only), Apple Safari (Mac OS X only)
  - VGA : PCIe 256MB GDDR3 video graphics card or higher
- ※ Some functions may be restricted even in supported browsers.









## RECOMMENDED MICRO SD/SDHC/SDXC MEMORY CARD SPECIFICATIONS



---

- Recommended capacity : 16GB to 256GB (MLC type required)
- Recommended Manufacturers : SanDisk, Transcend
- Product Type : High endurance
- It is recommended to use a memory card of 16GB or more that conforms to the UHS-3 class (MLC type) specification.
- The compatibility varies depending on the card manufacturers and types.







## WHAT'S INCLUDED

Please check if your camera and accessories are all included in the product package.  
(As for each sales country, accessories are not the same.)

Appearance	Item Name	Quantity	Description
	Camera	1	
	Quick Guide (Optional)	1	
	Cable for the testing monitor	1	Used to test the camera connection to a portable display device
	Template	1	Product installation guide
	Torx L Wrench	1	Used to remove and replace the dome cover
	Tapping Screw	4	Used for installation on the wall or ceiling
	Plastic Anchor	4	For fixing a screw, Inserted in a hole (reinforced anchoring force)
	Machine Screws	4	Used for assembling the dome case when installing the product on the pipe, wall mount, etc. or blocking a hole.
	Cap Installer	1	Used to connect the RJ45 cable.

Appearance	Item Name	Quantity	Description
	Card-type moisture absorbent	1	Attached when installed.
	Screw bit	1	Used for dome cover disassembly, assembly and camera installation.
	Cable Bushing	1	Used to connect the LAN cable with a diameter of $\varnothing 7-8.5$ .

**WHAT'S INCLUDED (LENS MODULE -OPTIONAL)**

Appearance	Item Name	Quantity	Description	Model Name
	Lens module	1	Mounted to PNM-9002VQ	SLA-2M2400Q
		1		SLA-2M2800Q
		1		SLA-2M3600Q
		1		SLA-2M6000Q
		1		SLA-5M3700Q
		1		SLA-5M4600Q
		1		SLA-5M7000Q

**AT A GLANCE**

**Appearance**

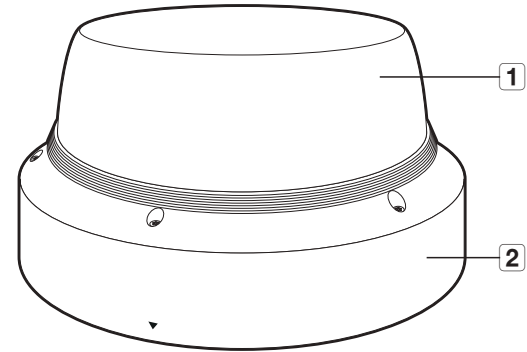

Item	Description
<b>1</b> Dome cover	Case cover used to protect the lens and the main unit.
<b>2</b> Camera Case	Housing part that covers the camera body.



## Components

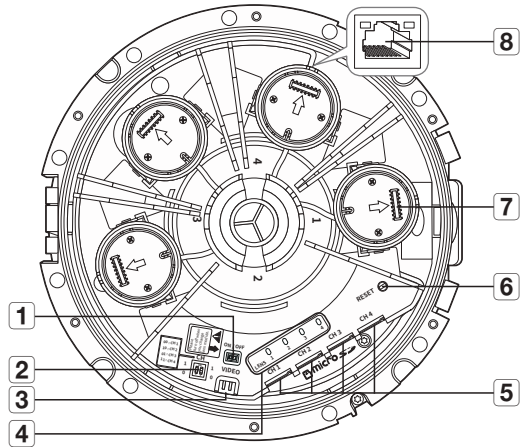

Item	Description
<b>1</b> Power On/Off switch	Switch used to turn the product On/off. <b>!</b> Use it only to replace your lens module.
<b>2</b> Channel DIP Switch	Change the DIP switches to specify the channel you want to use to view the installation video.
<b>3</b> Test Monitor Out Port	Output port for test monitoring the video output. Use the test monitor cable to connect to a mobile display and check the test video.
<b>4</b> Status Indicators for Lens Module (normal: green, abnormal: red)	If the lens module is attached correctly, the green LED will illuminate and then turn off after approximately 40 seconds. (to prevent undesirable reflections)
<b>5</b> Micro SD Card slot	Compartment for the Micro SD card.
<b>6</b> Reset Button	The button restores all camera settings to the factory default. Press and hold for about 5 seconds to reboot the system. <b>!</b> If you reset the camera, the network settings will be adjusted so that DHCP can be enabled. If there is no DHCP server in the network, you must run the Device Manager program to change the basic network settings such as IP address, Subnet mask, Gateway, etc., before you can connect to the network.
<b>7</b> Lens module mounting portion	This is the terminal to mount the lens module.
<b>8</b> PoE+ port	The terminal connects power and network through the PoE+ cable.

## AT A GLANCE (LENS MODULE)

### Appearance

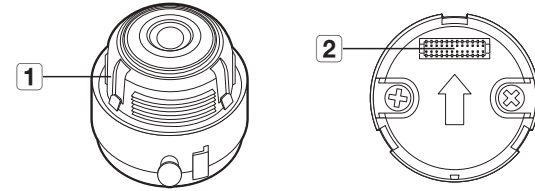

Item	Description
<b>1</b> Lens module	This is a lens module that records video.
<b>2</b> Camera connector	This is a terminal to connect with the camera.

## INSTALLATION

- ! This camera is waterproof and in compliance with the IP66 spec, but the jack connected to the external cable is not. You are recommended to install this product below the edge of eaves to prevent the cable from being externally exposed.

### Precautions before installation

Ensure you read out the following instructions before installing the camera:

- Select an installation site that can hold at least 5 times the camera's weight.
- Stuck-in or peeled-off cables can cause damage to the product or a fire.
- For safety purposes, keep anyone else away from the installation site. And put aside personal belongings from the site, just in case.
- If the product is installed with excessive force, it may cause damage to the camera due to malfunction. Forcing assembly using non-compliant tools may damage the product.
- Do not remove the lens module while the power is on.

### Disassembling

1. Remove the dome cover by loosening the fastening bolt of the dome cover. This can be done by turning it counterclockwise using the Torx L Wrench or screw bit provided.

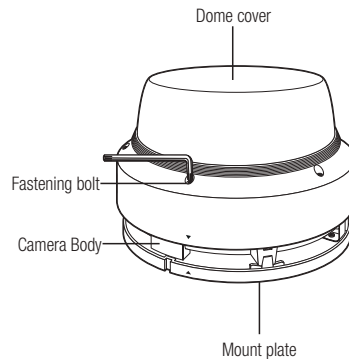

2. Loosen the fastening screw on the camera body.

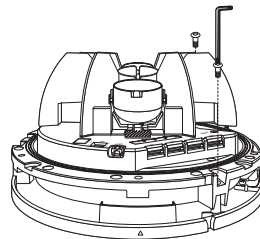

3. Remove the camera body and mounting plate by pulling the mounting clip, as shown in the figure.

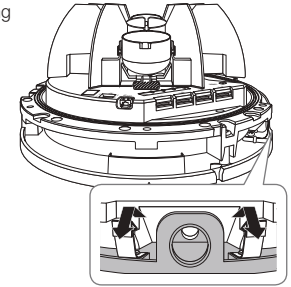

### Inserting a Micro SD card

1. Remove the dome cover of the camera.
2. Insert a Micro SD card in the arrow direction shown in the figure.

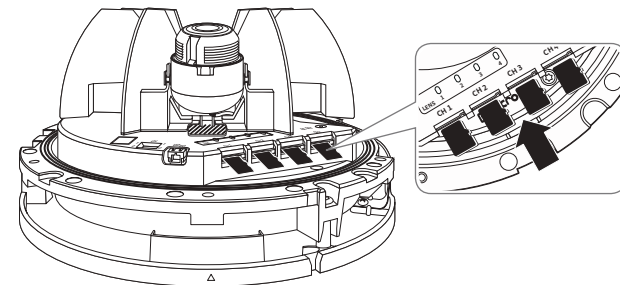

- !
  - Disconnect the power cable from the camera before inserting the Micro SD card.
  - Do not forcefully insert it in the reverse direction. It might damage your Micro SD card and your product.
  - When it rains or the humidity is high, insertion or ejection of a Micro SD card is not recommended.
  - Disassembly of the product cover should be finished within 5 minutes, or there will be the risk of internal dew condensation.

## Removing a Micro SD card

Gently press down on the exposed end of the Micro SD card as shown in the diagram to eject the Micro SD card from the slot.

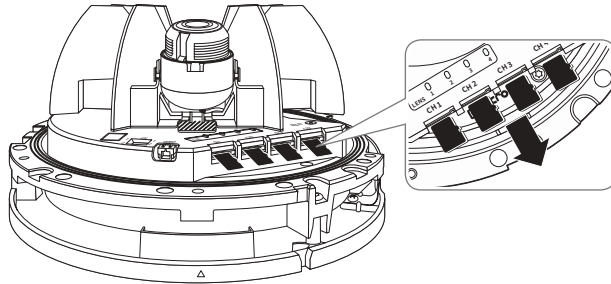

- ! You should save an SD card for each channel.
- Before removing the Micro SD card, in <Storage>, set the device to <Off> and press the [Apply] button and turn the camera off.
- If you turn off the camera or remove the Micro SD card that contains data from the product, the data may be lost or damaged.

## Mounting lens module

1. Align and fasten the connector of the lens module with the connector of the camera body.

- ! Install the lens module while power is not connected (PoE+).
- Check if the power switch is "OFF" before installing the lens module.
- You are recommended to avoid touching the lens separately, as it is shipped from the factory with the focus adjusted during the manufacturing inspection.

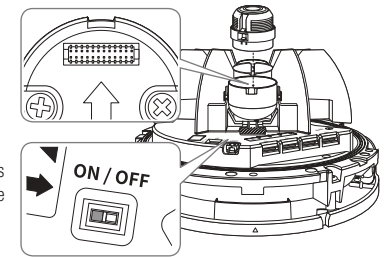

2. Complete the lens mounting process.  
3. Connect power to the product (PoE+).

- ! If you want to replace the lens module while connecting power to the product (PoE+), turn the power switch "OFF", replace the lens module, and then turn the power switch "ON".
- Be careful not to use any tool with a sharp point when handling the switch since it might be damaged.
- Be careful not to forcefully handle the switch since it might be damaged.

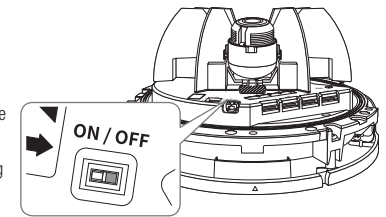

## How to install using the perpendicular falling method

You can move the lens for only one channel to see the video after installing it in the direct-lit manner. In this case, the lens direction of the moved channel can be tilted up to 90 degrees.

1. Tilt the lens module part forward-facing and then pull it.

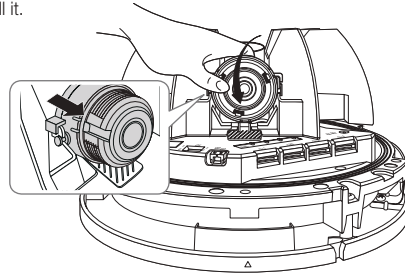

2. Align the groove with the center of the rotating part.

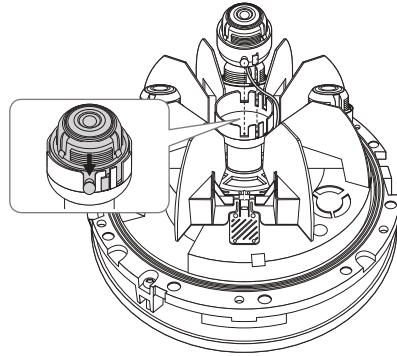

3. Lift the part with diagonal lines to release the frame wall.
4. Move the three channel lenses along the bottom rail.

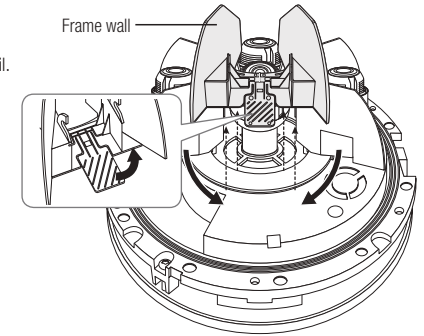

## How to install using the tilting method

You can move the lenses of CH1 - CH4 along the bottom rail to view videos by installing them using the tilting method.

In this case, the orientation of the lens cannot be tilted by 90 degrees.

1. Mount the frame wall.
2. Remove the direct-lit lens from the rotation center.
3. Move the four channel lenses along the bottom rail.

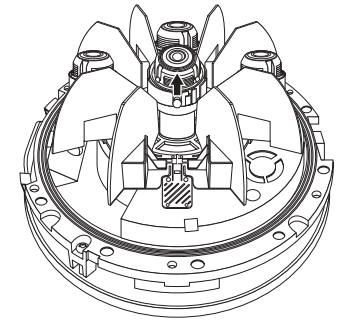

## Installation on a ceiling or wall

1. Use the provided template to drill holes for installation (diameter 6 mm and minimum depth 45mm) and insert the supplied plastic anchors to the end.

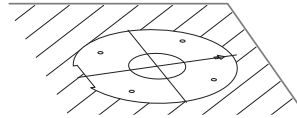

2. Align the holes of the mount plate for installation with the holes inserted with plastic anchors, and fasten the tapping screws.

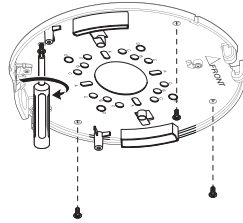

3. Connect the safety wire.

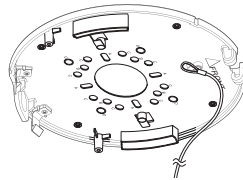

4. Mount the camera body to the mount plate.  
■ Mount it to fit the hinges as shown in the image.

5. Connect the terminal inside camera with the required cable.

! ■ If the lens module is not attached correctly, the lens module status light will illuminate red, as shown in the figure. If this occurs, turn off the power switch and reattach the lens module. If attached normally, it will illuminate green and then turn off after approximately 40 seconds.

6. Push in the mounting clip.

7. Adjust the lens to the desired direction by referring to "Adjusting the monitoring direction for the camera". (Page 17)

■ If you tilt the lens, you may need to adjust the lens as this may block the screen.

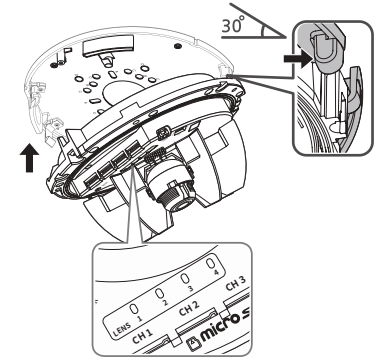

8. Assemble the dome cover.

■ Align the arrows when assembling the dome cover.

■ To ensure there are no issues with waterproofing, tighten the fastening bolts tightly using the Torx L wrench or screw bit.

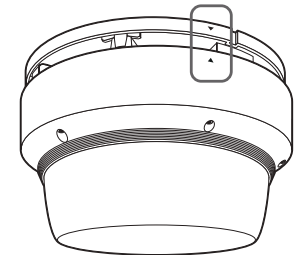

## Attaching to the unbundled adapter

Choose and purchase a necessary one of the following options (unbundled) that is suitable to the installation site or for your convenience.

1. Install the hanging mount to the wall mount adapter.
  - Wall mount adapters and hanging mounts are sold separately.

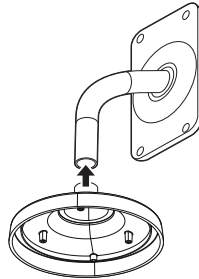

2. Connect the mounting plate and the hanging mount.

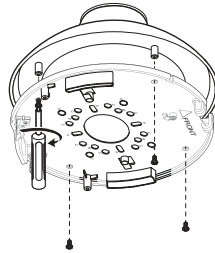

3. Connect the safety wire.

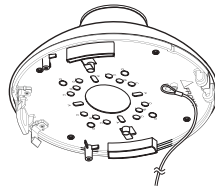

4. Mount the camera body to the mount plate.
  - Mount it to fit the hinges as shown in the image.
5. Connect the terminal inside camera with the required cable.
6. Push in the mounting clip.
7. Adjust the lens to the desired direction by referring to "Adjusting the monitoring direction for the camera". (Page 17)
  - If you tilt the lens, you may need to adjust the lens as this may block the screen.

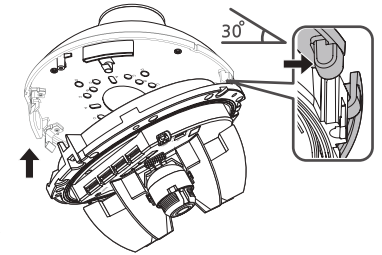

8. Assemble the dome cover.
  - Align the arrows when assembling the dome cover.
  - To ensure there are no issues with waterproofing, tighten the fastening bolts tightly using the Torx L wrench or screw bit.

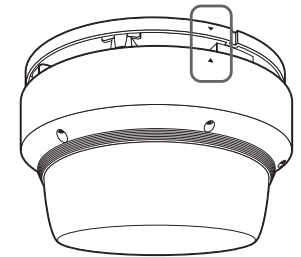

## Method 1. Connecting the LAN cable

1. Remove the dome cover and the case.
2. Pull out the long projected part of the rubber plug on the bottom and remove it as shown in the figure.

- !** ■ Use an appropriate cable bushing for the LAN cable to be connected.
- Basic camera : Use the cable with a diameter of  $\varnothing 5\sim 6.5$ .
  - Components provided : Use the cable with a diameter of  $\varnothing 7\sim 8.5$ .

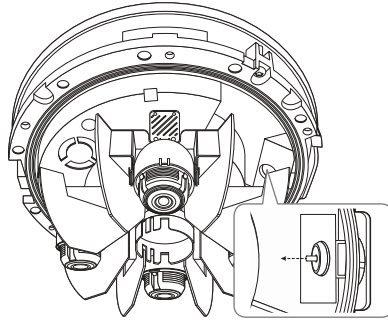

3. Insert the LAN cable through the hole appeared after removing the projected part in step 2 above.
4. Remove the sheath with a cable cutter, and align the cables.
5. Connect the LAN cable with a LAN connector, and insert it into the LAN tool.
6. Connect the finished cable to the Ethernet port.

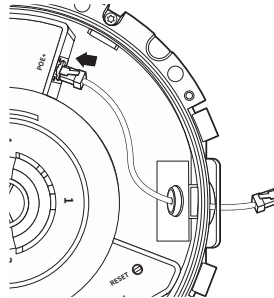

## Method 2. Connecting the LAN cable

1. Remove the dome cover and the case.
2. Pull out the long projected part of the rubber plug on the bottom and remove it as shown in the figure.
3. Pull the rubber cover over the hole to remove it.

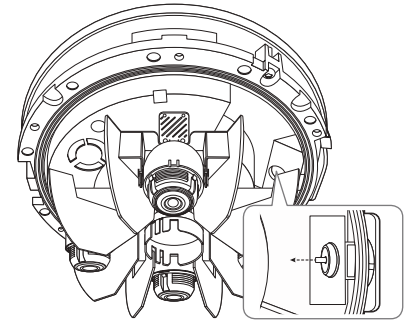

4. Use the Cap Installer to allow the RJ45 cable to pass through.

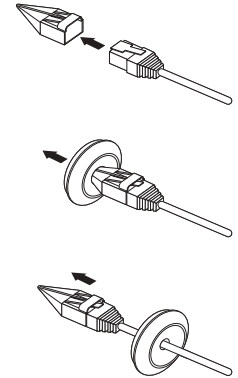

5. Insert the rubber stopper again and connect the LAN cable to the Ethernet terminal.

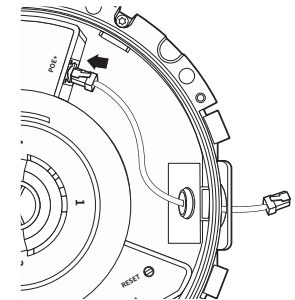

## How to set up channels to monitor for installation

The camera body has a channel DIP switch, as shown in the figure.

You can change the channel of the camera using the channel DIP switches.

CH1	CH2	CH3	CH4
00	01	10	11

-  ■ If a DIP switch is not fully On/Off, the product may malfunction. After installation, check the DIP switches at the back.
- Be careful, as you will risk damaging a DIP switch if you manipulate it using a sharp tool.
- Be careful, as a DIP switch may be damaged if you operate it with excessive force.

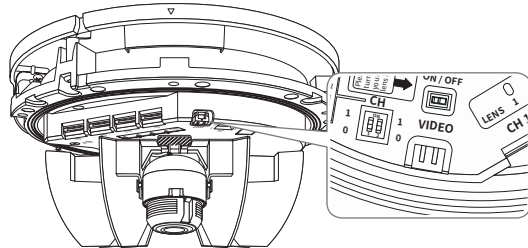

## Outdoor installation

When you install it outside of the building, please waterproof it with waterproof butyl rubber tape (can be purchased in stores) so that water does not leak from the gap of the cable connected to the outside.

1. Connect the PoE cable.
2. Wrap the black cable jacket (Area A) and the cable connection area with waterproof (butyl rubber) tape so that more than half of the butyl rubber tape is overlapped.



-  ■ If the cable jacket is not waterproofed properly, then it can directly cause leakage. Make sure to protect the cable with a dense layer of taping.
- Waterproof butyl tape is made of butyl rubber that can be stretched to twice its normal length.

## Optional Accessories for Installation

For your easier installation, you can purchase appropriate optional accessories available.

1. WALL MOUNT ADAPTOR(SBP-300WM/SBP-300WM1)/HANGING MOUNT(SBP-276HM)  
This adaptor is used when installing the dome camera onto a wall.

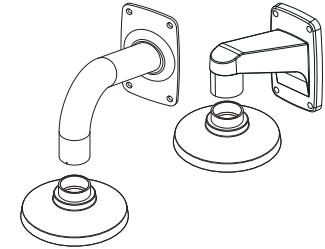

2. CEILING MOUNT ADAPTOR(SBP-300CM)/HANGING MOUNT(SBP-276HM)  
This adaptor is used when installing the dome camera on a concrete ceiling.

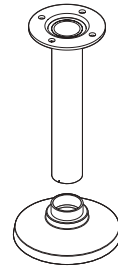

3. The POLE MOUNT ADAPTOR(SBP-300PM) is the adapter to be used when installing the WALL MOUNT ADAPTOR (SBP-300WM or SBP-300WM1) on an 80mm or larger column.

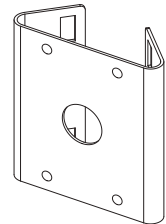

4. CORNER MOUNT ADAPTOR (SBP-300KM)  
This is an adaptor for WALL MOUNT ADAPTOR (SBP-300WM or SBP-300WM1) installation on the corner of wall joint.

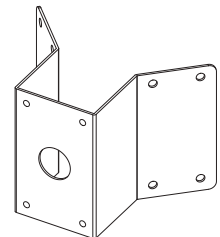



## Adjusting the monitoring direction for the camera

Moving the camera module (Pan)

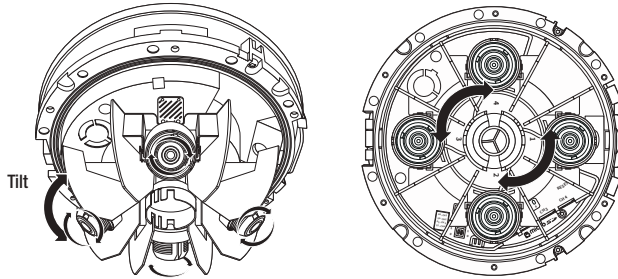

### Adjusting the monitoring direction

You can adjust the camera direction only when the camera is fixed on the ceiling.  
The act of moving the camera module is called "Pan"; adjusting its angle "Tilt"; rotating the lens along the axis "Rotate".

- The rotation angle of Pan is  $-90^{\circ}$  to  $+90^{\circ}$  for each module.
- The rotation angle of Rotation is  $-180^{\circ}$  to  $+180^{\circ}$ .
- The rotation angle of Tilt varies for each lens.

- !** The image can be covered up by the camera case depending on the angle.
- Do not pan over the specified rotation angle. It might damage the cable leading to a product malfunction.

### Methods of adjustment

1. After installing the camera in consideration of the direction to monitor, adjust the Pan angle along the bottom rail.
2. Adjust the horizontal angle so that the image does not appear to be reversed during rotation.
3. Adjust the tilt angle so that it points in the direction to be monitored.

## CONNECTING WITH OTHER DEVICE

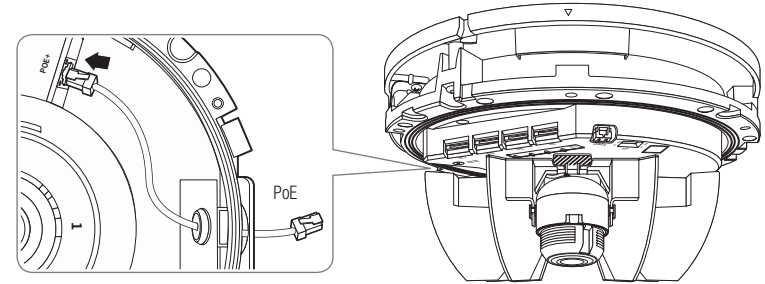

- !** The Test Monitor Out port of the product is provided for easier installation, and is not recommended for monitoring purposes.

### Powering and networking

Connect the PoE+ device with the PoE terminal of the camera.

- !** Connect and use a PoE+-enabled router.
- Use a PoE+ device that complies with the IEEE802.3at standard.

### Network Cable Specification

Item	Contents	Remark
Connector	RJ45 (10/100/1000BASE-T)	
Ethernet	10/100/1000BASE-T	To operate with 1000BASE-T, a cable of UTP-6 or higher should be used for the Giga hub.
Cable	Category 6	
Max Distance	100M	DC Resistance $\leq 0.125 \Omega/m$
PoE+ Support	IEEE 802.3at	

# network connection and setup

You can set up the network settings according to your network configurations.

## CONNECTING THE CAMERA DIRECTLY TO LOCAL AREA NETWORKING

### Connecting to the camera from a local PC in the LAN

1. Launch an Internet browser on the local PC.
2. Enter the IP address of the camera in the address bar of the browser.

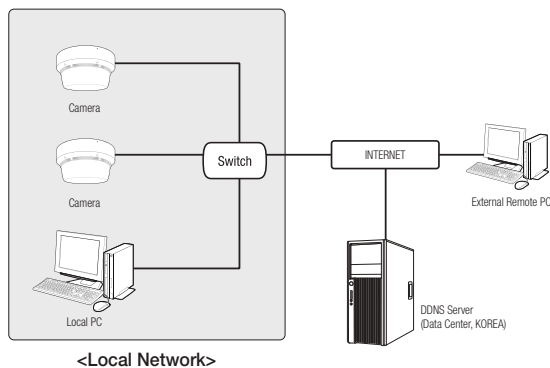

- A remote PC in an external Internet out of the LAN network may not be able to connect to the camera installed in the intranet if the port-forwarding is not properly set or a firewall is set. In this case, to resolve the problem, contact your network administrator.
- By factory default, the IP address will be assigned from the DHCP server automatically. If there is no DHCP server available, the IP address will be set to 192.168.1.100. To change the IP address, use the Device Manager. For further details on Device Manager use, refer to "Using Device Manager". (Page 19)

## CONNECTING THE CAMERA DIRECTLY TO A DHCP BASED DSL/CABLE MODEM

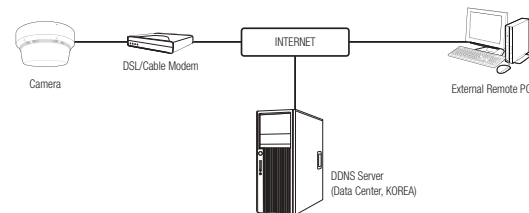

1. Connect the user PC directly with the network camera.
2. Run the Device Manager and change the IP address of the camera so that you can use the web browser on your desktop to connect to the Internet.
3. Use the Internet browser to connect to the web viewer.
4. Move to [Setup] page.
5. Move to [Network] – [DDNS] and configure the DDNS settings.
6. Move to [Basic] – [IP & Port], and set the IP type to [DHCP].
7. Connect the camera, which was removed from your PC, directly to the modem.
8. Restart the camera.

- For information on how to set DDNS, refer to the online help of Web Viewer.
- For information on how to set the IP format, refer to the online help of Web Viewer.

## USING DEVICE MANAGER

- Device manager program can be downloaded from <Technical Guides>-<Online Tool> menu at Hanwha Techwin website (<http://www.hanwha-security.com>).
- More instructions of Device Manager can be found at <Help> menu of the main page.

## AUTOMATICALLY SEARCHING CAMERA

If a camera is connected to the same network of the PC where device manager is installed, you can find network camera by using search function.

1. Click <Search> at the main page of device manager.
2. Check the camera from the list.
  - Check MAC address at the sticker attached to the camera.

## CONFIGURING IP ADDRESS

If you want to change camera network setting, <Login OK> sign must be displayed at <Status>. Click <Authentication> at the main page to log in.

### Configuring Static IP

Manually insert and configure IP address & port information.

1. Click the camera from the list that you want the change the IP setting.
2. Click <IP Assign> at the main page of device manager.
3. Select <Assign the following IP address>.
  - IP information of the camera will be displayed as previously set.
4. Fill in IP & Port related categories.



### If not using a Broadband Router

For setting <IP Address>, <Subnet Mask>, and <Gateway>, contact your network administrator.

- HTTP Port : Used to access the camera using the Internet browser, defaulted to 80.
- RTSP Port : A port that controls real-time streaming. The initial value is 554.

### If using a Broadband Router

- IP Address : Enter an address falling in the IP range provided by the Broadband Router.  
ex) 192.168.1.2~254, 192.168.0.2~254, 192.168.XXX.2~254
- Subnet Mask : The <Subnet Mask> of the Broadband Router will be the <Subnet Mask> of the camera.
- Gateway : The <Local IP Address> of the Broadband Router will be the <Gateway> of the camera.

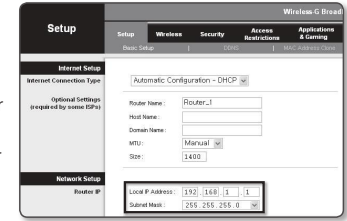

- The settings may differ depending on the connected Broadband Router model. For more information, refer to the user manual of the applicable router.
- For more information about port forwarding of the broadband router, refer to "Port Range Forward (Port Mapping) Setup". (Page 21)

### If the Broadband Router has more than one camera connected

Configure the IP related settings and the Port related settings distinctly with each other.

ex)

	Category	Camera #1	Camera #2
IP related settings	IP Address	192.168.1.100	192.168.1.101
	Subnet Mask	255.255.255.0	255.255.255.0
	Gateway	192.168.1.1	192.168.1.1
Port related settings	HTTP Port	8080	8081
	RTSP Port	554	555

- If the <HTTP Port> is set other than 80, you must provide the <Port> number in the address bar of the Internet browser before you can access the camera.  
ex) http://IP address : HTTP Port  
http://192.168.1.100:8080

5. Click [Apply] Button.
6. If the success message is displayed, click [OK].

## Configuring Dynamic IP

Receive IP address from DHCP

- Example of the Dynamic IP environment
  - If a Broadband Router, with cameras connected, is assigned an IP address by the DHCP server
  - If connecting the camera directly to modem using the DHCP protocols
  - If IPs are assigned by the internal DHCP server via the LAN

1. Click the camera from the list that you want to change the IP setting.
2. Click **<IP Assign>** at the main page of device manager.
3. Select **<Obtain an IP address automatically (DHCP)>**.
4. Click **[Apply]** button.
5. If the success message is displayed, click **[OK]**.



## AUTOMATICALLY CONFIGURING IP

1. Click the camera from the list that you want to automatically configure the IP.
2. Click **< + >** at the main page of device manager.
  - Equipment Setting menu appears.
3. At the menu, click **<Auto IP Configure>**.
4. Click **[Close]** button.

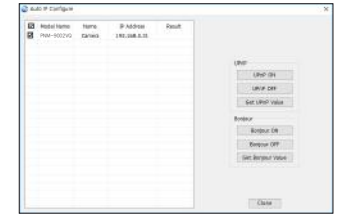

## MANUALLY REGISTERING CAMERA

If the camera cannot be found using search function, the camera can be registered remotely by manually inserting IP information, if the camera is connected to external network.

1. Click **<Add Devices>** - **<Manually Add Device>** at the main page of device manager.
2. Insert the range of IP address that you search.
3. Select the **<Model Name>** of the camera that you register, and insert HTTP port, ID, and password.
4. Click **[Register]** button.
5. Check if camera is registered.
  - Check MAC address at the sticker attached to the camera.

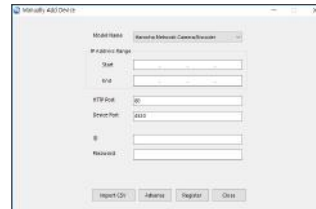

## PORT RANGE FORWARD (PORT MAPPING) SETUP

If you have installed a Broadband Router with a camera connected, you must set the port range forwarding on the Broadband Router so that a remote PC can access the camera in it.

### Manual Port Range Forwarding

- From the Setup menu of the Broadband Router, select **<Applications & Gaming>** - **<Port Range Forward>**.  
For setting the port range forward for a third-party Broadband Router, refer to the user guide of that Broadband Router.
- Select **<TCP>** and **<UDP Port>** for each connected camera to the Broadband Router.  
The number of each port to be configured to the IP router should be set according to the port number designated in **<Setup>** - **<Basic>** - **<IP & Port>** on the camera web viewer.
- When done, click **[Save Settings]**.  
Your settings will be saved.

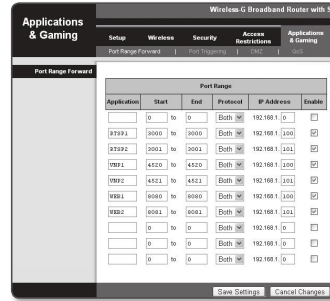

- Port forwarding setting is an example of setting CISCO IP router.
- The settings may differ depending on the connected Broadband Router model.  
For more information, refer to the user manual of the applicable router.

### Setting up Port Range Forward for several network cameras

- You can set a rule of Port Forwarding on the Broadband Router device through its configuration web page.
- A user can change each port using the camera setting screen.

When Camera1 and Camera2 are connected to a router :

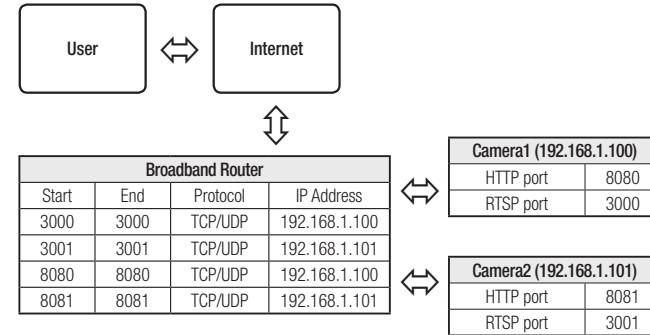

- Port forwarding can be done without additional router setup if the router supports the UPnP (Universal Plug and Play) function.  
After connecting the network camera, select the checkbox from the menu **<Quick connect>** in **<Wisenet DDNS>** in **"Settings -> Network -> DDNS"**.

## CONNECTING TO THE CAMERA FROM A SHARED LOCAL PC

---

1. Run device manager.  
It will scan for connected cameras and display them as a list.
2. Double-click a camera to access.  
The Internet browser starts and connects to the camera.

 ■ Access to the camera can also be gained by typing the camera's IP address in the address bar of the Internet browser.

## CONNECTING TO THE CAMERA FROM A REMOTE PC VIA THE INTERNET

---

On a remote computer that is not in the Broadband Router's network cluster is not allowed, users can access cameras within a Broadband Router's network by using the camera's DDNS URL.

1. Before you can access a camera in the Broadband Router network, you should have set the port range forward for the Broadband Router.
2. From the remote PC, launch the Internet browser and type the DDNS URL address of the camera, or the IP address of the Broadband Router in the address bar.  
ex) <http://ddns.hanwha-security.com/ID>

 ■ To use Wisenet DDNS, sign up at the Wisenet DDNS homepage (<http://ddns.hanwha-security.com>) and register the product at **[My DDNS]>[Register Product]**.

## CONNECTING TO THE CAMERA

### Normally, you would

1. Launch the Internet browser.
2. Type the IP address of the camera in the address bar.
  - ex) • IP address (IPv4) : 192.168.1.100 → http://192.168.1.100
  - the Login dialog should appear.
  - IP address (IPv6) : 2001:230:abcd:ffff:0000:0000:ffff:1111 → http://[2001:230:abcd:ffff:0000:0000:ffff:1111] - the Login dialog should appear.

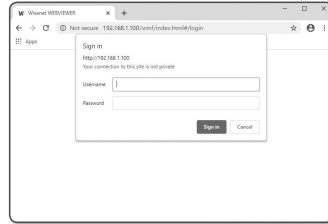

### If the HTTP port is other than 80

1. Launch the Internet browser.
2. Type the IP address and HTTP port number of the camera in the address bar.
  - ex) IP address : 192.168.1.100:HTTP Port number(8080)
  - http://192.168.1.100:8080 - the Login dialog should appear.

### Using URL

1. Launch the Internet browser.
2. Type the DDNS URL of the camera in the address bar.
  - ex) URL address : http://ddns.hanwha-security.com/ID
  - the Login dialog should appear.



- Network connection is disabled in the LAN only environment.

### Connecting via UPnP

1. Run the client or operating system in support of the UPnP protocol.
2. Click the camera name for search.
  - In the Windows operating system, click the camera name searched from the network menu.
  - The login window is displayed.

### Connecting via Bonjour

1. Run the client or operating system in support of the Bonjour protocol.
2. Click the camera name for search.
  - In the Mac operating system, click the camera name searched from the Bonjour tab of Safari.
  - The login window is displayed.

### To check the DDNS address

If the camera is connected directly to a DHCP-based cable modem or DSL modem, the IP address will change each time it tries to connect to the ISP (the company you subscribed to). If this is the case, you will not be informed of the IP address changed by DDNS.

Once you register a dynamic IP-based device with the DDNS server, you can easily check the changed IP when you try to access the device.

To register your device to the <DDNS> server, visit <http://ddns.hanwha-security.com> and register your device first, and then set the Web Viewer's <Network> - <DDNS> to <Wisenet DDNS>, as well as providing <Product ID> that had been used for DDNS registration.

## PASSWORD SETTING

When you access the product for the first time, you must register the login password.

- For a new password with 8 to 9 digits, you must use at least 3 of the following: uppercase/lowercase letters, numbers and special characters. For a password with 10 to 15 digits, you must use at least 2 types of those mentioned.
  - Special characters that are allowed: ~!@#%&^\*()\_+={}|[]?/
- For higher security, you are not recommended to repeat the same characters or consecutive keyboard inputs for your passwords.
- If you lost your password, you can press the **[RESET]** button to initialize the product. So, don't lose your password by using a memo pad or memorizing it.

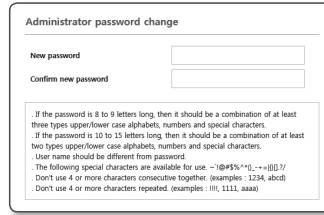

## LOGIN

Whenever you access the camera, the login window appears. Enter the User ID and password to access the camera.

1. Enter "admin" in the <User name> input box. The administrator ID, "admin", is fixed and can not be changed.
2. Enter the password in the <Password> input field.
3. Click **[Sign in]**.  
If you have logged in successfully, you will the Live Viewer screen.



- When you access the camera web viewer, pay special attention to the security by checking whether the image data is encrypted.
- You will experience the best video quality if the screen size is 100%. Reducing the ratio may cut the image on the borders.

## CAMERA WEB VIEWER SETUP

1. Click the **[Setup (⚙️)]** icon.
2. The Settings window appears.
3. You can configure settings for the camera's basic information, video, audio, network, event, analysis, and system over the network.
4. Click **<Help (🔗)>** to view detailed descriptions of each function.



## TROUBLESHOOTING

PROBLEM	SOLUTION
<b>No video is displayed when accessing the plug-in free webviewer on Safari via HTTPS.</b>	<ul style="list-style-type: none"> <li>On the authentication popup window prompted when initially accessing https, click "View Authentication Certificate" and select the "Always trust when connecting to the designated webviewer IP" check box.</li> <li>If the webviewer continues failing to display a video after you select "Next" on the message window below, press the command key + Q to exit the Safari browser, access again and follow the procedures stated above.</li> </ul>
<b>I can't access the camera from a web browser.</b>	<ul style="list-style-type: none"> <li>Check to make sure that the camera's Network settings are appropriate.</li> <li>Check to make sure that all network cables have been connected properly.</li> <li>If connected using DHCP, verify that the camera is able to acquire dynamic IP addresses without any problem.</li> <li>If the camera is connected to a Broadband Router, verify that port forwarding is properly configured.</li> </ul>
<b>Viewer got disconnected during monitoring.</b>	<ul style="list-style-type: none"> <li>Connected Viewers become disconnected upon any change to camera or network configurations.</li> <li>Check all network connections.</li> </ul>
<b>The camera connected to the network is not detected in the Device Manager program.</b>	<ul style="list-style-type: none"> <li>Turn off the firewall settings on your PC and then search the camera again.</li> </ul>

PROBLEM	SOLUTION
<b>Images overlap.</b>	<ul style="list-style-type: none"> <li>Check whether two or more cameras are set to a single multicast address instead of different addresses. If a single address is used for multiple cameras, the images may overlap.</li> </ul>
<b>No image appears.</b>	<ul style="list-style-type: none"> <li>If the transmission method is set to multicast, check whether there is a router that supports multicast in the LAN the camera is connected to.</li> <li>Check whether the lens module is operating normally.</li> </ul>
<b>&lt;Motion detection&gt; of &lt;Analytics&gt; is set to &lt;Enable&gt;, but no notification e-mail reaches me even when an analysis event had occurred.</b>	<ul style="list-style-type: none"> <li>Verify the settings in the following sequence:                             <ol style="list-style-type: none"> <li>Check &lt;Data &amp; Time&gt; settings.</li> <li>The &lt;Motion detection&gt; should be set to &lt;Enable&gt;.</li> <li>Check if the &lt;E-mail&gt; option of &lt;Event setup&gt; menu is checked to use.</li> </ol> </li> </ul>
<b>Cannot record into the Micro SD card.</b>	<ul style="list-style-type: none"> <li>Check if the Micro SD card is defective.</li> </ul>
<b>Micro SD card is inserted but the camera does not operate properly.</b>	<ul style="list-style-type: none"> <li>Check if the Micro SD card is inserted in the proper direction. Operation of Micro SD card that is formatted by other devices is not guaranteed with this camera unit</li> <li>Format the Micro SD card again in &lt;Setup&gt; → &lt;Event&gt; → &lt;Storage&gt; menu.</li> </ul>



Any changes or modifications in construction of this device which are not expressly approved by the party responsible for compliance could void the user's authority to operate the equipment.

This device complies with part 15 of the FCC Rules. Operation is subject to the following two conditions: (1) This device may not cause harmful interference, and (2) this device must accept any interference received, including interference that may cause undesired operation.

This equipment has been tested and found to comply with the limits for a Class A digital device, pursuant to part 15 of the FCC Rules. These limits are designed to provide reasonable protection against harmful interference when the equipment is operated in a commercial environment.

This equipment generates, uses, and can radiate radio frequency energy and, if not installed and used in accordance with the instruction manual, may cause harmful interference to radio communications. Operation of this equipment in a residential area is likely to cause harmful interference in which case the user will be required to correct the interference at his own expense.

- Reorient or relocate the receiving antenna.
- Increase the separation between the equipment and receiver.
- Connect the equipment into an outlet on a circuit different from that to which the receiver is connected.
- Consult the dealer or an experienced radio/TV technician for help.



Hanwha Techwin cares for the environment at all product manufacturing stages, and is taking measures to provide customers with more environmentally friendly products.

The Eco mark represents Hanwha Techwin's devotion to creating environmentally friendly products, and indicates that the product satisfies the EU RoHS Directive.



#### Correct Disposal of This Product (Waste Electrical & Electronic Equipment)

(Applicable in the European Union and other European countries with separate collection systems)

This marking on the product, accessories or literature indicates that the product and its electronic accessories (e.g. charger, headset, USB cable) should not be disposed of with other household waste at the end of their working life. To prevent possible harm to the environment or human health from uncontrolled waste disposal, please separate these items from other types of waste and recycle them responsibly to promote the sustainable reuse of material resources.

Household users should contact either the retailer where they purchased this product, or their local government office, for details of where and how they can take these items for environmentally safe recycling.

Business users should contact their supplier and check the terms and conditions of the purchase contract. This product and its electronic accessories should not be mixed with other commercial wastes for disposal.



#### Correct disposal of batteries in this product

(Applicable in the European Union and other European countries with separate battery return systems.)

This marking on the battery, manual or packaging indicates that the batteries in this product should not be disposed of with other household waste at the end of their working life. Where marked, the chemical symbols Hg, Cd or Pb indicate that the battery contains mercury, cadmium or lead above the reference levels in EC Directive 2006/66. If batteries are not properly disposed of, these substances can cause harm to human health or the environment.

To protect natural resources and to promote material reuse, please separate batteries from other types of waste and recycle them through your local, free battery return system.

