

WISENET

4-Channel Multi-Directional Camera

User Manual

HCM-9020VQ

CE

4-Channel Multi-Directional Camera

User Manual

Copyright

©2017 Hanwha Techwin Co., Ltd. All rights reserved.

Trademark

Each of trademarks herein is registered. The name of this product and other trademarks mentioned in this manual are the registered trademark of their respective company.

Restriction

Copyright of this document is reserved. Under no circumstances, this document shall be reproduced, distributed or changed, partially or wholly, without formal authorization.

Disclaimer

Hanwha Techwin makes the best to verify the integrity and correctness of the contents in this document, but no formal guarantee shall be provided. Use of this document and the subsequent results shall be entirely on the user's own responsibility. Hanwha Techwin reserves the right to change the contents of this document without prior notice.

❖ Design and specifications are subject to change without prior notice.

Safety information



CAUTION

RISK OF ELECTRIC SHOCK.
DO NOT OPEN



CAUTION:

TO REDUCE THE RISK OF ELECTRIC SHOCK, DO NOT REMOVE COVER (OR BACK) NO USER SERVICEABLE PARTS INSIDE. REFER SERVICING TO QUALIFIED SERVICE PERSONNEL.



This symbol indicates that dangerous voltage consisting a risk of electric shock is present within this unit.



This exclamation point symbol is intended to alert the user to the presence of important operating and maintenance (servicing) instructions in the literature accompanying the appliance.

WARNING

- To prevent damage which may result in fire or electric shock hazard, do not expose this appliance to rain or moisture.
- To prevent injury, this apparatus must be securely attached to the floor/wall in accordance with the installation instructions.

WARNING

1. Be sure to use only the standard adapter that is specified in the specification sheet.
Using any other adapter could cause fire, electrical shock, or damage to the product.
2. Incorrectly connecting the power supply or replacing battery may cause explosion, fire, electric shock, or damage to the product.
3. Do not connect multiple cameras to a single adapter. Exceeding the capacity may cause abnormal heat generation or fire.
4. Securely plug the power cord into the power receptacle. insecure connection may cause fire.
5. When installing the camera, fasten it securely and firmly. The fall of camera may cause personal injury.

Safety information

6. Do not place conductive objects (e.g. screwdrivers, coins, metal parts, etc.) or containers filled with water on top of the camera. doing so may cause personal injury due to fire, electric shock, or falling objects.
7. Do not install the unit in humid, dusty, or sooty locations. doing so may cause fire or electric shock.
8. If any unusual smells or smoke come from the unit, stop using the product. in such case, immediately disconnect the power source and contact the service center. continued use in such a condition may cause fire or electric shock.
9. If this product fails to operate normally, contact the nearest service center. never disassemble or modify this product in any way. (samsung is not liable for problems caused by unauthorized modifications or attempted repair.)
10. When cleaning, do not spray water directly onto parts of the product. doing so may cause fire or electric shock.

CAUTION

1. Do not drop objects on the product or apply strong shock to it. Keep away from a location subject to excessive vibration or magnetic interference.
2. Do not install in a location subject to high temperature (over 55°C), low temperature (below -30°C), or high humidity. Doing so may cause fire or electric shock.
3. If you want to relocate the already installed product, be sure to turn off the power and then move or reinstall it.
4. Remove the power plug from the outlet when there is a lightning. Neglecting to do so may cause fire or damage to the product.
5. Keep out of direct sunlight and heat radiation sources. It may cause fire.
6. Install it in a place with good ventilation.
7. Avoid aiming the camera directly towards extremely bright objects such as sun, as this may damage the CMOS image sensor.
8. Apparatus shall not be exposed to dripping or splashing and no objects filled with liquids, such as vases, shall be placed on the apparatus.
9. The Mains plug is used as a disconnect device and shall stay readily operable at any time.
10. Do not expose the camera to radioactivity. Radioactivity exposure may damage the CMOS.

FCC Statement

This device complies with part 15 of the FCC Rules. Operation is subject to the following two conditions :

- 1) This device may not cause harmful interference, and
- 2) This device must accept any interference received including interference that may cause undesired operation.

CAUTION

This equipment has been tested and found to comply with the limits for a Class A digital device, pursuant to part 15 of FCC Rules. These limits are designed to provide reasonable protection against harmful interference when the equipment is operated in a commercial environment. This equipment generates, uses, and can radiate radio frequency energy and, if not installed and used in accordance with the instruction manual, may cause harmful interference to radio communications. Operation of this equipment in a residential area is likely to cause harmful interference in which case the user will be required to correct the interference at his own expense.



IC Compliance Notice

This Class A digital apparatus meets all requirements of the Canadian Interference-Causing Equipment Regulations of ICES-003.

Correct Disposal of This Product (Waste Electrical & Electronic Equipment)



(Applicable in the European Union and other European countries with separate collection systems)

This marking on the product, accessories or literature indicates that the product and its electronic accessories (e.g. charger, headset, USB cable) should not be disposed of with other household waste at the end of their working life. To prevent possible harm to the environment or human health from uncontrolled waste disposal, please separate these items from other types of waste and recycle them responsibly to promote the sustainable reuse of material resources.

Household users should contact either the retailer where they purchased this product, or their local government office, for details of where and how they can take these items for environmentally safe recycling.

Business users should contact their supplier and check the terms and conditions of the purchase contract. This product and its electronic accessories should not be mixed with other commercial wastes for disposal.

Correct disposal of batteries in this product



(Applicable in the European Union and other European countries with separate battery return systems.)

This marking on the battery, manual or packaging indicates that the batteries in this product should not be disposed of with other household waste at the end of their working life. Where marked, the chemical symbols Hg, Cd or Pb indicate that the battery contains mercury, cadmium or lead above the reference levels in EC Directive 2006/66. If batteries are not properly disposed of, these substances can cause harm to human health or the environment.

To protect natural resources and to promote material reuse, please separate batteries from other types of waste and recycle them through your local, free battery return system.

Important safety instructions

1. Read these instructions.
2. Keep these instructions.
3. Heed all warnings.
4. Follow all instructions.
5. Do not use this apparatus near water.
6. Clean only with dry cloth.
7. Do not block any ventilation openings. Install in accordance with the manufacturer's instructions.
8. Do not install near any heat sources such as radiators, heat registers, or other apparatus (including amplifiers) that produce heat.
9. Do not defeat the safety purpose of the polarized or grounding-type plug. A polarized plug has two blades with one wider than the other. A grounding type plug has two blades and a third grounding prong. The wide blade or the third prong is provided for your safety. If the provided plug does not fit into your outlet, consult an electrician for replacement of the obsolete outlet.
10. Protect the power cord from being walked on or pinched particularly at plugs, convenience receptacles, and the point where they exit from the apparatus.
11. Only use attachments/accessories specified by the manufacturer.
12. Use only with cart, stand, tripod, bracket, or table specified by the manufacturer, or sold with the apparatus.
13. Unplug this apparatus when a card is used. Use caution when moving the cart/ apparatus combination to avoid injury from tip-over.
14. Refer all servicing to qualified service personnel. Servicing is required when the apparatus has been damaged in any way, such as powersupply cord or plug is damaged, liquid has been spilled or objects have fallen into the apparatus, the apparatus has been exposed to rain or moisture, does not operate normally, or has been dropped.
15. This product is intended to be supplied by a Listed Power Supply Unit marked "Class 2" or "LPS" and rated from 24 Vac (50/60 Hz) min.0.6 A or 12 Vdc, min.0.7 A.
16. If you use excessive force when installing the product, the camera may be damaged and malfunction.
If you forcibly install the product using non-compliant tools, the product may be damaged.
17. Do not install the product in a place where chemical substances or oil mist exists or may be generated. As edible oils such as soybean oil may damage or warp the product, do not install the product in the kitchen or near the kitchen table.
This may cause damage to the product.
18. When installing the product, be careful not to allow the surface of the product to be stained with chemical substance.
Some chemical solvents such as cleaner or adhesives may cause serious damage to the product's surface.
19. If you install/disassemble the product in a manner that has not been recommended, the production functions/performance may not be guaranteed.
Install the product by referring to "Installation & connection" in the user manual.
20. Installing or using the product in water can cause serious damage to the product.



Apparatus shall not be exposed to dripping or splashing and no objects filled with liquids, such as vases, shall be placed on the apparatus

Precautions for Installation and Use

1. Users should not disassemble the camera arbitrarily.
2. Users should be careful of handling the camera. Users should not punch or shake the camera. They should be careful of not causing damage due to careless keeping or wrong operation.
3. The camera should not be installed in places where it rains or there is high humidity. It should not be operated under wet environments.
4. The camera surface should not be cleaned by harsh abrasive. When it gets dirty, it should be cleaned with dry towel.
5. The camera is installed in cool places where there is no direct sunlight.
The direct sunlight may cause bad affect on the product.



Hanwha Techwin cares for the environment at all product manufacturing stages, and is taking measures to provide customers with more environmentally friendly products. The Eco mark represents Hanwha Techwin's devotion to creating environmentally friendly products, and indicates that the product satisfies the EU RoHS Directive.

Contents

INTRODUCTION	9	Characteristics
	10	Components
	12	Names and Designations of each parts
	9	
INSTALLATION	13	Precautions before installation
	13	How to install the camera
	16	How to adjust camera angle of 4 sensor module
	17	How to adjust the camera monitoring direction
	13	
CONNECTION	18	How to connect cables
	19	How to connect alarm output terminal
	20	How to connect monitors
	18	
CAMERA OPERATION	21	How to configure OSD menu of each camera
	23	Menu configuration
	24	How to configure functions
	25	Exposure compensation
	29	Color
	30	Day and night mode
	31	Image ADJ
	32	Motion
	33	Privacy
	35	Setup
	36	Exit
	21	
TROUBLESHOOTING	37	Troubleshooting
	37	
SPECIFICATIONS	38	Specifications
	40	Dimension
	38	

Introduction







Characteristics





- High Definition AHD over Coax Technology
- Four Cameras in One, One Installation
- 1/3" 2M CMOS sensor x 4
- Flexible Sensor Positioning with Magnets
- 8 Megapixel Resolution at 30fps (4x 2.1MP)
- 4.0mm X 2, 6.0mm X 2 Fixed Lenses
- OSD Control Via Coaxial (UTC)
- OSD Menu with Built-in Joystick
- Secondary Video-BNC Output
- SENS-UP Super Low Light Technology
- True Day/Night Mechanical IR Cut Filter
- Dynamic Range Compressor (DRC) Reveals Low Light Detail
- Wide Dynamic Range (WDR)
- Smart DNR™ 3D Digital Noise Reduction
- High Light Compensation (HLC)
- Programmable Privacy Zones
- Auto Gain Control (AGC)
- Backlight Compensation (BLC)
- Auto White Balance (AWB)
- RS-485 Built-in
- Auto Sensing 12V DC/24V AC with Line Lock
- Defog Extreme Weather Image Compensation
- IP66 Certified (Weather Resistant)

Introduction

Components

Unpack the box, and check whether all components are included as follows.

Appearance	Product Name	Quantity	Use
	Camera	1	4-Channel Multi-Directional Camera
	Simple Instructions	1	
	Tapping screws	3	Used to install on ceilings, walls, etc.
	Plastic anchors	3	To tighten screws to installation places. Inserted to holes (To reinforce the installation)
	Template	1	Installation Guide
	L wrench	1	Used for assembly and disassembly of dome covers

Appearance	Product Name	Quantity	Use
	For test monitoring Cable	1	Camera test by connecting with a portable display
	Card-type moisture absorbent	2	Attached to the inner side of a dome cover
Option			
	Power adapter and power cord	1	Used for power connection (Solely used in Korea / optional)
	Gang mount box plate	1	Plate for Gang mount box installation (Solely used in Area of the Americas / optional)
	Machine screws	3	Used to fix the camera when it is installed on gang mount box plate

Introduction

Names and Designations of each parts

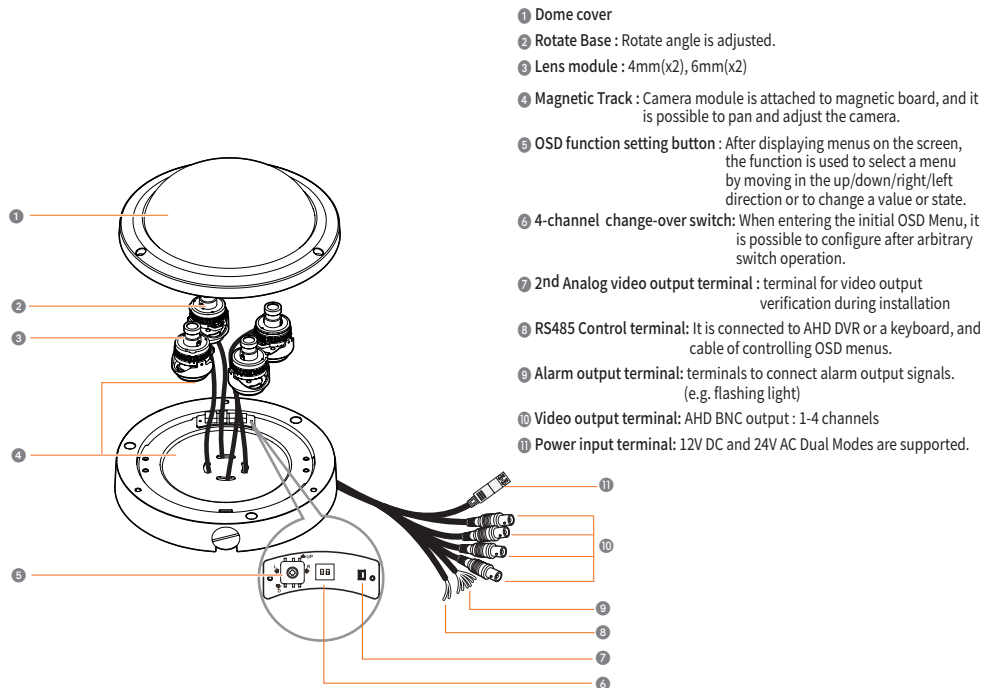

Installation

Precautions before installation

Be well-informed of precautions before installation as follows.

- The camera should be installed to a wall or ceiling that wears as much as 5-times weight of the camera.
- When a cable is trapped in improper location or its skin is damaged, it may cause the product damage or fire.
- Before installation, focus, zoom, etc. of the camera should be adjusted.
- During installation, access by unnecessary persons should be prevented.

How to install the camera

How to disassemble

1. Use L wrench to loosen camera dome cover screws.
2. Remove the camera module protection PEfoam.
3. Remove the camera cap.
4. Remove the dome cover inner protection sticker.
5. Remove the dome cover outer protection sticker.

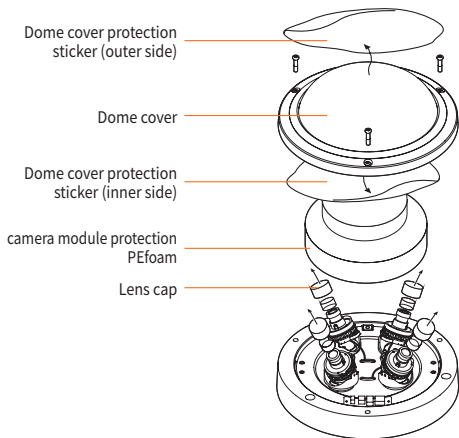

Installation

When installing on a ceiling or a wall

1. Attach an installation template on a place you want, and drill 3 holes as shown in the picture.
2. 3 anchors are driven into 3 holes above.
3. 3 given tapping screws are driven into anchors above to fix the camera.
4. Connect a cable to the camera. Be careful not to damage the cable. It should be trimmed up.
5. Refer to "How to adjust monitoring direction of the camera", and adjust the lens in a direction you want.
6. Assemble the dome cover into the body.
7. Remove the dome cover protection sticker.



- If a wall or ceiling is not strong enough to sustain the camera, it may fall. So, after the installation surface is reinforced, it should be installed.
- Use L wrench to tightly fix dome cover screws.

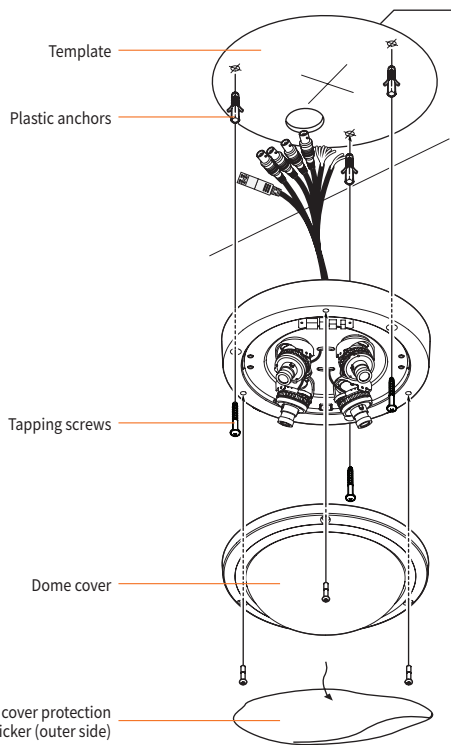

When installing on gang mount box

1. Use 3 given screws to fix the camera into 3 gang mount box plates (optional).
2. Connect a cable to the camera. Be careful not to damage the cable. It should be trimmed up.
3. Refer to "How to adjust monitoring direction of the camera", and adjust the lens in a direction you want.
4. Assemble the dome cover into the body.
5. Remove the dome cover protection sticker.



- Use L wrench to tightly fix dome cover screws.

Gang mount box plate
(solely used in area of the
Americas / optional)

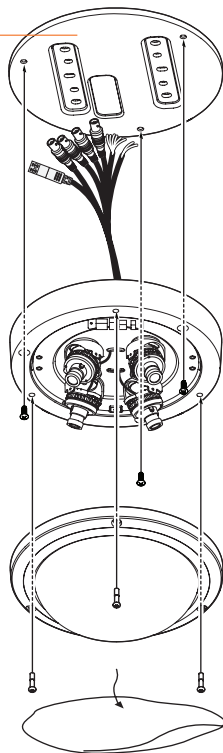

Installation

How to adjust camera angle of 4 sensor module

It is possible to tilt and rotate the angle of each sensor module as follows.

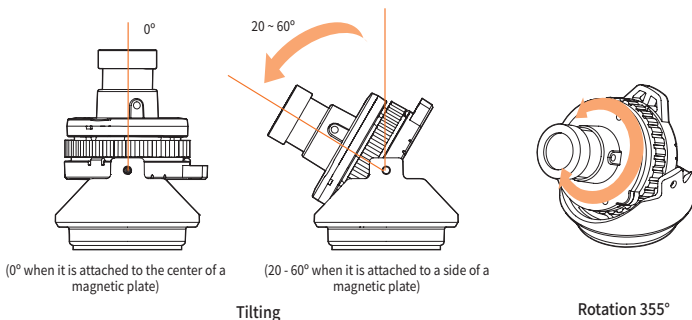

▪ Monitoring direction adjustment

When a camera is fixed onto the ceiling, it is possible to adjust its direction. Panning means rotation of the camera body left or right. Tilt means up and down inclination. Rotation means turning on the lens pivot.

- Panning angle is total 360°.

- Rotation angle is total 355°.

- Tilting angle is

- 1) fixed to 0° when it is attached to the center of a magnetic plate.
- 2) 20 - 60° when it is attached to a side of a magnetic plate.

▪ How to adjust

1. After attaching the camera on Magnetic board, the panning angle is adjusted considering the monitoring direction.
2. The horizontal angle is adjusted such that the video reversal does not occur during rotation.
3. Adjust the tilting angle to face on the monitoring direction.



- Since the camera module is made of magnet, it should be careful for cable damage during disassembly.

How to adjust the camera monitoring direction

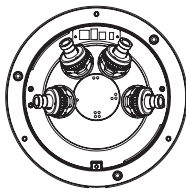

1. 180° configuration

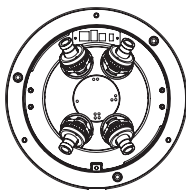

2. Random configuration

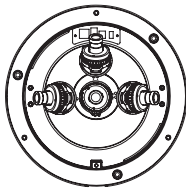

3. Random configuration

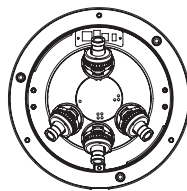

4. Random configuration

INSTALL GUIDE ANGLE

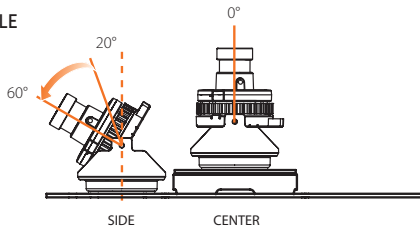

- When mounting the camera module on the side, the quality of the image will not be guaranteed if the tilt angle of the camera exceeds the recommended angle.
- When a camera module is installed at the right angle of 0°, it should be located on the center.

Connection

How to connect cables

Refer to the following figure to connect the camera to external devices.

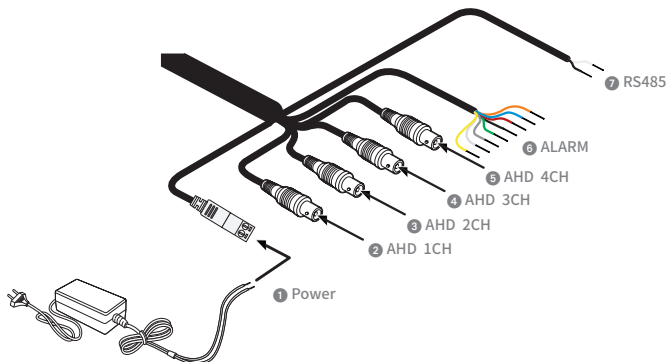

- ① Power : The camera is connected to a proper power source. The camera supports both 12V DC and 24V AC. Following is the maximum power of the power supply equipment.

DC12V : 0.7A / 6.7W (MAX_TDN ON)
AC24V : 0.6A / 7.3W (MAX_TDN ON)

- ② ~ ⑤ 1-4 ch AHD BNC outputs : AHD_Ch 1 to AHD_Ch 4 of each camera are connected to a DVR that supports AHD video.

- ⑥ How to connect alarm terminal :

Alarm terminal connection method : Camera alarm cables are connected to (+) and (-) terminals of sensor/alarm devices, and it operates in short- or open-circuit method according to alarm occurrence or not.

1# DOUT +	ORANGE	3# DOUT +	GREEN
1# DOUT -	RED	3# DOUT -	GRAY
2# DOUT +	YELLOW	4# DOUT +	WHITE
2# DOUT -	BLUE	4# DOUT -	BLACK

- ⑦ RS485 device connection method : RS485 cables are connected to (+) and (-) terminals of a controller or DVR equipment.

1) WHITE cable : RS485 -
2) BLACK cable : RS485 +

How to connect alarm output terminal

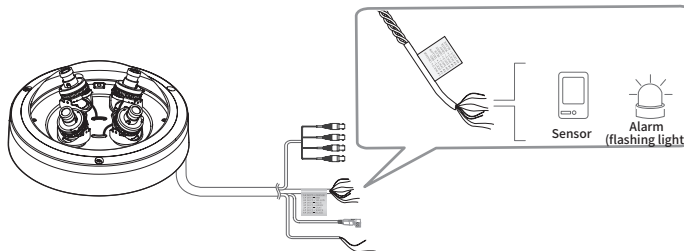

- Alarm output terminal:(+): terminal to connect alarm output signals. (e.g. flashing light)
- Alarm output terminal:(-): common terminal to connect alarm output signals.



- When it is connected to devices (flashing light, siren, etc.) that use excessive voltage or current in Open-Collector method, it may be broke down. When it is connected to devices that use excessive voltage or current, please refer to "Alarm output connection diagram".

1. Alarm operation :

Alarm terminal connection method : Camera alarm cables are connected to (+) and (-) terminals of sensor/alarm devices, and it operates in short- or open-circuit method according to alarm occurrence or not.

- 1) Short circuit : for alarm output (50Ω short circuit)
- 2) Open circuit : for no alarm output (open circuit)

2. Alarm output load spec : 400V / 100mA

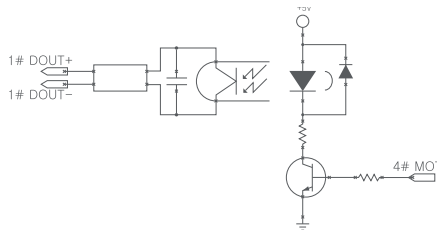

<Inside of the camera>

Connection

How to connect monitors

Refer to the following figure to connect monitors through AHD DVR.

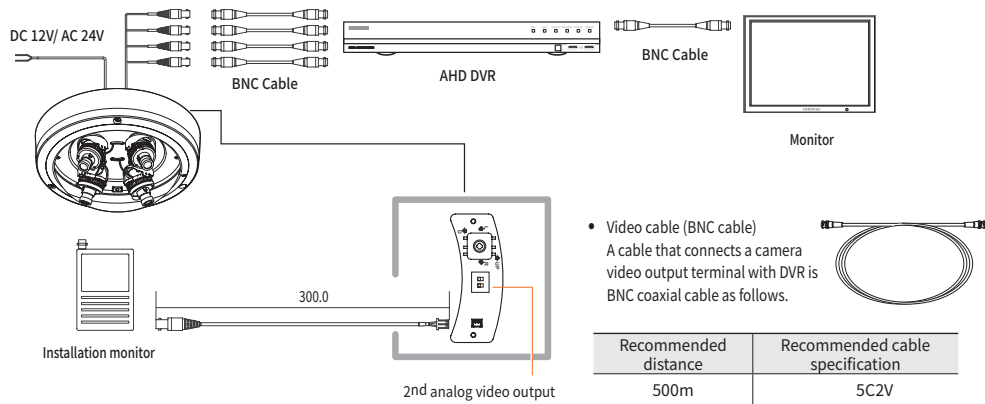

- Dual power of 12V DC / 24V AC can be used. (Be careful the power polarity when the 12V DC is used.)
- Every 4-channel camera can supply 2nd analog video output for on-site shooting.



- 2nd analog video output for channels with 4-ch change-over function can be monitor for 60 seconds through an analog monitor. In order to continuously monitor the same channel after 60 seconds, please change 4-ch change-over switch to a different channel and then select a channel you want.
- Be sure to connect devices while the power is off.

Camera operation

How to configure OSD menu of each camera

A camera has 4 sensor modules, and each sensor module can configure its own OSD menu.

When a camera is configured, unique values are set to each sensor.

When OSD menu of each sensor module, one of the following options is selected.

1. There are BNC outputs for 4 AHD videos, each channel can communicate using UTC (Up the Coax).
BNC outputs of 4 AHD videos from a camera is connected to a DVR that supports UTC communication such as SRD-893P/1694P or all-in-one DVR, it is possible to configure OSD menu of each channel by using UTC communication of DVR itself.
2. It is possible to remotely control OSD configuration of 4 channels by using external peripheral devices through RS485 communication.
3. There are OSD function configuration button and 4-ch change-over switch in OSD control board of the camera.
2nd analog video output of a selected channel can be displayed on CRT monitor by using 4-ch change-over switch, and it is possible to configure OSD as well.
2nd analog video output can be checked by CRT monitor. 2nd analog video output availability is notified on the upper right corner of AHD video for 60 seconds.
Please refer to images on the following page about switch configuration for each channel selection



- During the initial OSD menu entry, 4-ch change-over switch is arbitrarily modified just once for the first time, and then it is possible to enter OSD menu according to each channel switch configuration.

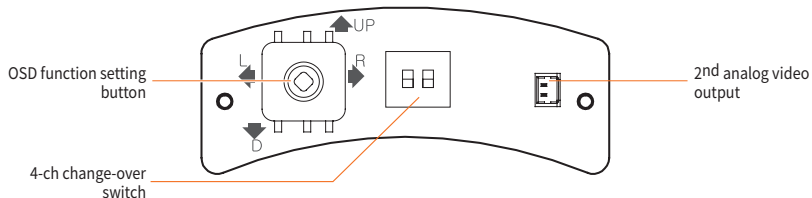

Camera operation

- 4-ch change-over switch

Referring to the following image, users configure "4-ch change-over switch" to a sensor module they want.

When "4-ch change-over switch" is set to each sensor module, OSD menu of the sensor module is set to "OSD function setting button."

2nd analog video output can be checked by CRT monitor. 2nd analog video output availability is notified on the upper right corner of AHD video for 60 seconds.

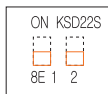

BNC Local Output for Sensor #1

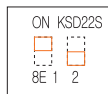

BNC Local Output for Sensor #2

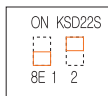

BNC Local Output for Sensor #3

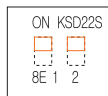

BNC Local Output for Sensor #4



- During the initial OSD menu entry, 4-ch change-over switch is arbitrarily modified just once for the first time, and then it is possible to enter OSD menu according to each channel switch configuration.

Menu configuration

Function Configuration Menu		
EXPOSURE	LENS	BRIGHTNESS / SHUTTER
	BACKLIGHT	OFF / HLC / BLC / WDR
	DRC	OFF / LOW / MIDDLE / HIGH
	DEFOG	OFF / ON
	AGC	1 ~ 10
	SENS-UP	OFF / x2 ~ x32
	3D DNR	OFF / LOW / MIDDLE / HIGH
	RETURN	Move to the startup menu
COLOR	WHITE BAL	AUTO / AUTO-EX / PRESET / MANUAL
	COLOR GAIN	0 ~ 20
	RETURN	Move to the startup menu
DAY&NIGHT	MODE	AUTO / COLOR / B&W
	AGC THRES	0 ~ 20
	AGC MARGIN	0 ~ 20
	DELAY	LOW / MIDDLE / HIGH
FUNCTION	RETURN	Move to the startup menu
	SHARPNESS	0 ~ 10
	GAMMA	0.45 ~ 0.75
	MIRROR	OFF / ON
	FLIP	OFF / ON
	D-ZOOM	x1.0 ~ x16.0
RETURN	Move to the startup menu	

Function Configuration Menu		
MOTION	MOTION	OFF / ON
	DET WINDOW	
	SENSITIVITY	0 ~ 10
	TEXT ALARM	OFF / ON
	ALARM OUT	OFF / ON
PRIVACY	RETURN	Move to the startup menu
	BOX	OFF / ON
	POLYGON	OFF / ON
SETUP	RETURN	Move to the startup menu
	CAM ID	1~250
	CAM TITLE	OFF / ON
	FRAME RATE	1080_30P / 720_30P
	LANGUAGE	16 languages
	INIT	OFF / ON
EXIT	RETURN	Move to the startup menu
	SAVE&EXIT	
	EXIT	
RETURN		

Camera operation

How to configure functions

Function configuration uses OSD function setting button inside the dome cover.

1. Push the OSD function setting button.
 - Enter into the function setting state. Displays the function setting menu on a monitor.
2. Select a function you want by pushing the OSD function setting button.
 - Adjust the OSD function setting button to indicate an item you want.
3. Use the OSD function setting button to change the current state.
4. If you want to end, select 'EXIT' button, and then push the OSD function setting button to end.



- You can move from a mode that has ←↓ to its lower menu by pushing the function setting button.
- Modes with --- cannot be used according to the function setting state.

MENU	
EXPOSURE	←↓
COLOR	←↓
DAY&NIGHT	←↓
FUNCTION	←↓
MOTION	←↓
PRIVACY	←↓
SETUP	←↓
EXIT	←↓

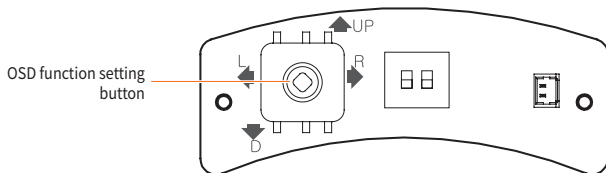

Exposure compensation

Lens

The camera lens mode has default setting of "AUTO", and it automatically sets the camera IRIS.

It is possible to adjust the followings using lower menu of the Lens:

- **Brightness**
changes the level according to the ambient brightness.
- **Shutter**
Sets the shutter speed to Auto, Manual, or Flicker-less mode.



- **Auto**
 - Indoor : is set under indoor environments.
 - Outdoor : is set under outdoor environments.
 - If Manual is set, the shutter speed can be adjusted as 1/30, 1/60, 1/120 - 1/30000.

EXPOSURE	
LENS	↵ ↴
BACKLIGHT	OFF
DRC	OFF
DEFOG	OFF
AGC	10 ██████████
SENS-UP	x4
3D DNR	HIGH
RETURN	↵ ↴

LENS	
BRIGHTNESS	8 ██████████
SHUTTER	AUTO ↵ ↴
RETURN	↵ ↴

Camera operation

Backlight compensation

- **HLC (HIGH LIGHT COMPENSATION)**

Bright area around the subject is masked with a pre-specified color, and it facilitates the subject identification.

Masked weighing values can be user-configurable, and its level has 0-20.

0th level has more weighting values, and 20th level has less weighting values.

- Level : sets HLC weighting values.
- Color : sets masking colors.
 - Can be specified in the order of black, white, yellow, cyan, green, magenta, red, and blue.

- **BACK LIGHT COMPENSATION)**

When it is difficult to identify due to the backlight of the subject, the backlit area is set separately to help identify the subject .

- H-POS: moves a Zone location right/left.
- V-POS: moves a Zone location up/down.
- H-Size: changes a horizontal Zone size.
- V-Size: changes a vertical Zone size.

- **Wide Dynamic Range**

When there is bright area around the subject indoors, the function helps simultaneously identify both bright and bright areas around the subject. When one wants to uniformly adjust bright light area from indoor video, weighting factors for the bright light are set to 'Low', 'Middle', and 'High' . 'Low' has a lower weighting factor, and 'High', higher.

EXPOSURE	
LENS	↵
BACKLIGHT	OFF
DRC	OFF
DEFOG	OFF
AGC	10 ██████████
SENS-UP	x4
3D DNR	HIGH
RETURN	↵

BACKLIGHT	
LEVEL	10 ██████████
COLOR	BLACK
RETURN	↵

BACKLIGHT	
H-POS	6
V-POS	6
H-SIZE	8
V-SIZE	8
RETURN	↵

BACKLIGHT	
LEVEL	HIGH
RETURN	↵

DRC

It compensates and compresses bright and dark areas of captured videos to help to better understand neighboring scenes.

Compensation level for dark and bright areas can be set by users. 'Low' has a lower weighting factor, and 'High', higher.

"But, when DEFOG mode is used, DRC menu setting is changed to "----" mode.

EXPOSURE	
LENS	←↓
BACKLIGHT	OFF
DRC	OFF
DEFOG	OFF
AGC	10 ██████████
SENS-UP	x4
3D DNR	HIGH
RETURN	←↓

Defog

The mode is set to 'Auto' or 'Manual' by users in order to help to better identify foggy objects or ambient scenes due to fog.

When DEFOG is set to 'Manual', its level can be set to 'Low', 'Middle', and 'High'.

"But, when DEFOG mode is used, DRC menu setting is changed to "----" mode.

- **Auto** : DEFOG is automatically set according to any any operation environment.
- **Manual** : Forces the DEFOG function to operate.
- **Level** : changes DEFOG weighting factors.

EXPOSURE	
LENS	←↓
BACKLIGHT	OFF
DRC	OFF
DEFOG	OFF
AGC	10 ██████████
SENS-UP	x4
3D DNR	HIGH
RETURN	←↓

DEFOG	
MODE	AUTO
LEVEL	MIDDLE
RETURN	←↓

Camera operation

Auto Gain Control

It amplifies the gain of a video signal, and facilitates to see dark video as brightly. When it gets dark, it becomes impossible to control the brightness only by IRIS or shutter speed. In that case, the function amplifies AGC Gain. Only under dark environments, Gain is amplified, but under bright environments, it is not.

The amplification level is 1 to 10 (0 is no amplification, and a higher value gives higher amplification.), and it can be set by users.

"But, a higher level of AGC may increase the noise level as much as the brightness."

EXPOSURE	
LENS	←↓
BACKLIGHT	OFF
DRC	OFF
DEFOG	OFF
AGC	10 ██████████
SENS-UP	x4
3D DNR	HIGH
RETURN	←↓

SENS-UP

Under low light levels, users can set the mode for a better view of objects or ambient scenes, and its default value is X2. Its setting level can be set to Off, X2, X4, X8, X16, and X32. A higher level produces brighter video under low light levels. But, in a higher level, there may occur video echo phenomenon.

EXPOSURE	
LENS	←↓
BACKLIGHT	OFF
DRC	OFF
DEFOG	OFF
AGC	10 ██████████
SENS-UP	x4
3D DNR	HIGH
RETURN	←↓

3D DNR (3D Digital Noise Reduction)

Under dark environments, AGC function operates and produces more noise. The function decreases the noise to enhance the video quality. There are 4 noise reduction levels as Off, Low, Middle, and High. At Off mode, there is the biggest noise, and at High mode, the smallest.

Color

White Balance

- Auto**
 The feeling of screen color is automatically set to 2,400K° - 11,000K° to compensate the feeling of color naturally.
- Outdoor compensation**
 Users set the feeling of screen color to 2,500K° - 12,000K° to compensate the feeling of color naturally.
- Preset**
 Under a specific environment, users set the feeling of screen color to compensate the feeling of color naturally.
- Manual**
 Users arbitrarily set the feeling of screen color to compensate the feeling of color naturally. C-TEMP basic level is 5,000K°, the level can have one of 5000K°, 8000K°, and 3000K°. R-Gain level of a warm feeling is "0-20", and users control the feeling of red color. B-Gain level of a cold feeling is "0-20", and users control the feeling of blue color.

COLOR	
WHITE BAL.	MANUAL ← ↓
COLOR GAIN	7 ▯▯▯▯▯▯▯▯▯▯
RETURN	← ↓

WHITE BAL	
C-TEMP	5000X
R-GAIN	10 ▯▯▯▯▯▯▯▯▯▯
B-GAIN	10 ▯▯▯▯▯▯▯▯▯▯
RETURN	← ↓

Color Gain

- Color gain**
 Users can naturally set a concentration level for the feeling of video image color. The basic setting level is "7", the level varies 0-20.

COLOR	
WHITE BAL.	MANUAL ← ↓
COLOR GAIN	7 ▯▯▯▯▯▯▯▯▯▯
RETURN	← ↓

Camera operation

Day and night mode

Day and night mode setting

- Auto

Users can set the Auto mode to produce day-time video with a natural feeling of color and night-time video with vivid black and white image.

- Duration : sets the starting time for Day and night mode to change. (The default setting value is 10.)
- Range : sets a marginal value between day time and night time. If the range value is set so low, a margin between day time and night time is so low and the day and night mode may be repeated frequently. (The default setting value is 18.)
- Dwell Time : sets a delay time of the day and night mode.

- Color

maintains the color state regardless of ambient environments. When the color mode is set, Duration, Range, and Dwell Time cannot be changed to "---" mode.

- B&W

maintains the B&W state regardless of ambient environments.

When the B&W mode is set, Duration, Range, and Dwell Time cannot be changed to "---" mode.

DAY&NIGHT	
MODE	AUTO
AGC THRES	10
AGC MARGIN	18
DELAY	LOW
RETURN	⏴⏵

Image ADJ

Sharpness

Compensates contours of the subject in video image to enhance its view.
The default setting is "3". The level varies 0(low level) to 20(high level), and can be set by users.

Gamma

User's contrast level adjustment appropriate for a monitor characteristic produces more natural video for objects or ambient environments. It produces more natural video image on the monitor. The default setting is "0.5". The level varies 0.45(bright image) to 0.75(dark image), and can be set among 7 levels by users.

H-REV / V-REV

- H-REV_USE**
It is possible to reverse video or image display on a monitor in the direction of left and right, and it can be set by users.
- V-REV_USE**
It is possible to reverse video or image display on a monitor in the direction of up and down, and it can be set by users.

FUNCTION	
SHARPNESS	3
GAMMA	0.5
MIRROR	OFF
FLIP	OFF
D-ZOOM	1.0X
RETURN	↵



H-REV / V-REV Off



H-REV On



V-REV On



H-REV / V-REV On

D-Zoom

Users can set the level in order to enlarge a subject in the central area of video image, and it can be set by users.
The default setting is "1.0X". The level varies 1.0X(no enlargement) to 16.X(max enlargement), and can be set among 150 levels by users.

Camera operation

Motion

Motion

Detects motion of the subject in video image. Displays it on motion-detection OSD, and can generate alarm signals to the outside. Should control motion detection settings for each sensors.

Det Area

- INDICATOR : displays MOTION ZONE on video.
- SEL AREA : configures MOTION ZONE. (configures 4 kinds of Zones.)
- Mode : uses or not each Zone.
- DET H-POS : moves Zone left/right.
- DET V-POS : moves Zone up/down.
- DET H-Size : changes horizontal Zone size.
- DET V-Size : changes vertical Zone size.

Sensitivity

sets the operation sensitivity.

OSD

displays the status of alarm occurrences.

- Motion!! : When there is any motion in the camera video image, "Motion!!" alarm is generated.

MOTION	
MOTION	ON
DET WINDOW	↕
SENSITIVITY	5 ██████████
TEXT ALARM	OFF
ALARM OUT	ON
RETURN	↕

DET WINDOW	
MOTION OSD	OFF
WINDOW USE	0
WINDOW ZONE	ON
DET H-POS	0
DET V-POS	0
DET H-SIZE	60
DET V-SIZE	34
RETURN	↕

Privacy

Box

Specified area in video image can be hidden in a form of quadrangle in order to mask privacy information.

It is possible to use 16 types of privacy masking areas. The camera supports quadrangle privacy masks.

- Zone Num : selects 1-16 Zones.
- Zone DISP : turns off or on a corresponding area and sets Privacy Zone.
- H-POS : moves Zone left/right.
- V-POS : moves Zone up/down.
- H-Size : changes horizontal Zone size.
- V-Size : changes horizontal Zone size.
- Y LEVEL : sets Zone brightness.
- CR LEVEL / CB LEVEL : sets Zone color.
- Transparency : sets Zone transparency.

PRIVACY

BOX	ON ◀↓
POLYGON	OFF
RETURN	◀↓

BOX

ZONE NUM	0
ZONE DISP	ON
H-POS	0
V-POS	0
H-SIZE	60
V-SIZE	34
Y LEVEL	10 ▒▒▒▒▒▒▒▒▒▒▒▒▒▒▒▒
CB LEVEL	10 ▒▒▒▒▒▒▒▒▒▒▒▒▒▒▒▒
CR LEVEL	10 ▒▒▒▒▒▒▒▒▒▒▒▒▒▒▒▒
TRANS	2
RETURN	◀↓

Camera operation

Polygon

Specified area in video image can be hidden in a form of polygon in order to mask privacy information. It is possible to use 8 types of privacy masking areas. The camera supports high-quality polygon masks.

- **Zone Num** : selects 1-8 Zones.
- **Mode** : turns off or on a corresponding area and sets Privacy Zone.
- **H-POS** : moves a polygon of a corresponding area horizontally.
- **v-POS** : moves a polygon of a corresponding area vertically.
- **POS1-X** : adjusts the upper right part left/right.
- **POS1-Y** : adjusts the upper right part up/down.
- **POS2-X** : adjusts the lower right part left/right.
- **POS2-Y** : adjusts the lower right part up/down.
- **POS3-X** : adjusts the lower left part left/right.
- **POS3-Y** : adjusts the lower right part left/right.
- **Y LEVEL** : sets Zone brightness.
- **CR LEVEL / CB LEVEL** : sets Zone color.
- **Transparency** : sets Zone transparency.

PRIVACY	
BOX	ON ← ↓
POLYGON	OFF
RETURN	← ↓

BOX	
ZONE NUM	0
MODE	ON
H-POS	80
V-POS	5
POS1-X	88
POS1-Y	5
POS2-X	88
POS2-Y	13
POS3-X	80
POS3-Y	13
Y LEVEL	10 ██████████
CB LEVEL	10 ██████████
CR LEVEL	10 ██████████
TRANS	2
RETURN	← ↓

Setup

CAM ID

When RS-485 terminal is used to connect an external device, CAM ID is set to the same value to communicate with.

Cam Title

Names or special characters can be added to camera video images.

It is configured that users can display a title on a screen.

It is possible to display a camera name on the upper right, upper left, lower right, or lower left corner of the screen.

SETUP	
CAM ID	1
CAM TITLE	OFF
FRAME RATE	1080_30P
LANGUAGE	ENGLISH
INIT	OFF
RETURN	←↓

FRAME RATE

Users can configure the default resolution of a video to 1080_30P or 720_30P.

Language

Users can select an OSD language among 16.

INIT

At the current specified channel, it is initialized to the initially configured OSD menu values.

When each channel is needed to be initialized, it can be executed by the corresponding channel menu.

Camera operation

EXIT

SAVE & EXIT

Changed values are saved and the device exits from the OSD Menu.

EXIT

Changed values are not saved and the device exits from the OSD Menu.

Return

Moves to the upper menu.



Troubleshooting

Troubleshooting

If you think the system is out of order, please check the following items.

If the problem continues, please contact your local representative where you bought.

Troubles	How to solve
When you can see nothing on the screen	<ul style="list-style-type: none">▶ Check if the power is correctly connected and supplied.▶ Check if coaxial cables are correctly connected.
When the screen is not clear	<ul style="list-style-type: none">▶ Is there dust on the lens? Clean the lens with clean cloth or brush.▶ Adjust the monitor state.▶ When bright light comes in the screen, adjust the camera location or angle.▶ Check manual focus and zoom adjust of the lens. You'd better use a field test monitor.
When the screen is dark	<ul style="list-style-type: none">▶ Adjust the state of a monitor or DVR.▶ Check if the termination process between systems is well done.
When color is not matched	<ul style="list-style-type: none">▶ Check if 'White balance' is correctly set during the function setup.
When the screen blinks	<ul style="list-style-type: none">▶ Check if the camera is headed for the Sun or fluorescent lights.

Specifications

Specifications

Category	HCM-9020VQ
VIDEO	
Image Sensor	1/3" 2M CMOS sensor x4
Active Pixels	1,944(H) x 1,092(V) X 4ea pixels
Scanning System	Progressive scan
Frequency	60Hz / 50Hz
Signal Technology	8 Megapixel AHD (4 x 2MP Sensors)
Synchronization	Internal
Resolution	8.0 Megapixel (4x 1920x1080 Sensors)
Minimum Scene Illumination Video Output	Color(at Day) : 0.1Lux (4mm, F2.6, 30IRE) / 0.1Lux or below (6mm, F2.0, 30IRE) B/W(at Night) : 0.01Lux (4mm, F2.6, 50IRE) / 0.01Lux or below (6mm, F2.0, 50IRE) 4x AHD 1080p at 30fps
Alarm Output	4x Alarm Outputs
LENS	
Focal Length & Lens Type	4.0mm X 2, 6.0mm X 2 Fixed Lenses
ENVIRONMENTAL	
Operating Temperature & Humidity	-30°C - +50°C / 90% RH or lower ※ When the power turn OFF → ON, it should be done at a temperature of -10°C or higher.
IP Rating	IP66 (Weather Resistant)

Category	HCM-9020VQ
Other Certifications	FCC, CE, ROHS
ELECTRICAL	
Power Requirements	DC12V/AC24V Dual Voltage
Power Consumption	DC12V : 0.7A / 6.7W (MAX_TDN ON) AC24V : 0.6A / 7.3W (MAX_TDN ON)
MECHANICAL	
Housing Material and Dimensions	Aluminum, 199 x 89.5 (7.83 x 3.52 In)
Weight	4.4 lbs (2kg)

※ This specification may be modified for improvement without prior notification.

Specifications

Dimension

Unit : mm(inch)

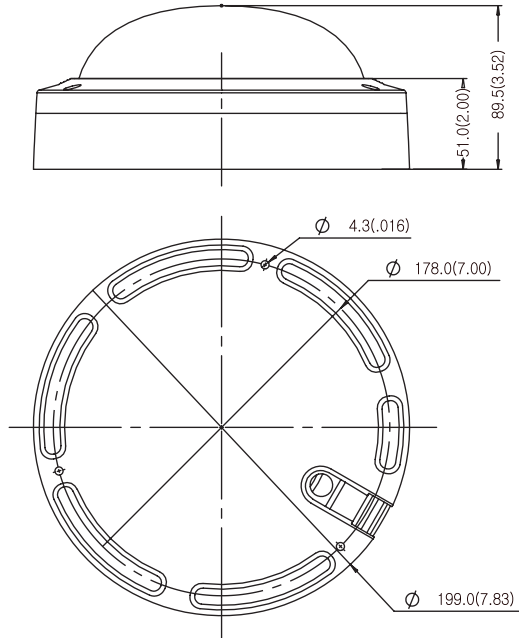

MEMO

Head Office

6, Pangyo-ro 319 beon-gil, Bundang-gu, Seongnam-si,

Gyeonggi-do, 463-400 Rep. of KOREA

Tel : +82.70.7147.8753 Fax : +82.31.8018.3740

www.hanwha-security.com

Hanwha Techwin America

500 Frank W. Burr Blvd. Suite 43 Teaneck, NJ 07666

Toll Free +1.877.213.1222 Direct +1.201.325.6920

Fax +1.201.373.0124

www.hanwha-security.com

Hanwha Techwin Europe

Heriot House, Heriot Road, Chertsey, Surrey, KT16 9DT, United Kingdom

Tel +44.1932.57.8100 Fax +44.1932.57.8101

www.hanwha-security.eu
