

**WISENET**

# **NETWORK VIDEO RECORDER**

Quick Guide

XRN-420S/QRN-430S

CE

## Features

The product records video and audio from network cameras to a hard disk, and enables playback from the hard disk. It also provides remote monitoring environment for video and audio over the network using a remote computer.

- Provides new UI 2.0
- Supports instant viewer
- Can be linked to AI camera
- Supports AI search (people, face, vehicle, license plate) (XRN-420S)
- Supports BestShot view
- Bookmark function
- Thumbnail function (Not supported in web viewer)
- View camera event list in real time
- Convenient event rule setup
- Various sequence (layout, page) functions
- Extended search period
- Convenient log search
- Supports thermal imaging camera/PTZ linked camera
- Supports a range of 4K camera resolutions
- Outputs a 4K high definition image using HDMI
- Record and play video
- Record and play audio
- Supports ONVIF Profile S standard and RTP / RTSP protocols
- Display the HDD operation status by HDD SMART
- HDD overwrite enabled
- Function to export using USB memory and external hard disk
- Simultaneous play of 4 channels
- View multi-channel time line when playing videos
- Various Search Modes (Time, Event, Smart, Text, Export, ARB)
- ARB support (configuration feature for saving period by channel)
- Various recording modes (Normal, Event, Scheduled Recording)
- Alarm Input / Output
- Remote monitoring function by Windows Network Viewer
- Live monitoring of the network camera
- Installation Wizard Function (Recorder, Web Viewer)
- Supports the smartphone remote monitoring feature by P2P support
- Provides smartphone event alarm (sending real-time event messages)

### CAUTION

- RISK OF EXPLOSION IF BATTERY IS REPLACED BY AN INCORRECT TYPE. DISPOSE OF USED BATTERIES ACCORDING TO THE INSTRUCTIONS.
- Do not ingest battery, Chemical Burn Hazard.
- This product contains a coin / button cell battery. If the coin / button cell battery is swallowed, it can cause severe internal burns in just 2 hours and can lead to death.
- Keep new and used batteries away from children. If the battery compartment does not close securely, stop using the product and keep it away from children. If you think batteries might have been swallowed or placed inside any part or the body, seek immediate medical attention.







### ATTENTION

- IL Y A RISQUE D'EXPLOSION SI LA BATTERIE EST REMPLACÉE PAR UNE BATTERIE DE TYPE INCORRECT. METTRE AU REBUT LES BATTERIES USAGÉES CONFORMÉMENT AUX INSTRUCTIONS.
- Ne pas ingérer la pile, risque de brûlure chimique.
- Ce produit contient une pile de type bouton/pièce de monnaie. Si la pile de type bouton/pièce de monnaie est avalée, elle peut causer de graves brûlures internes en seulement 2 heures et peut entraîner la mort.
- Gardez les piles neuves et usagées hors de portée des enfants. Si le compartiment de la pile ne se ferme pas correctement, cessez d'utiliser le produit et gardez-le d'atteinte des enfants. Si vous suspectez que des piles ont été avalées ou insérées dans une partie du corps, consultez un médecin sans tarder.

## Package Contents

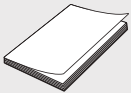

- The appearance of the components may differ from the image shown.
- Accessory category and quantity may differ depending on sales region.
- For some regions, HDD is not pre-installed. HDD Fixing Screw, SATA Cable quantity vary depending on the model.

		
Recorder	Mouse	Power Cable
		
Power Adaptor	Quick Guide	HDD Fixing Screw (For models having no installed HDD)
		
SATA Power Cable (For models having no installed HDD)		

## Installing the HDD

- ❗ If you are adding a new or previously used HDD to this product in addition to the HDD(s) originally installed, format the new HDD manually in the set before use. To learn how to format, see "Device/Format" in the User Manual.
- If you wish to replace or add an HDD, contact your dealer or our customer service first.

 ■ The following figures are based on Model QRN-430S.

- 1 Loosen the screws on the back and slide the cover back to remove it.

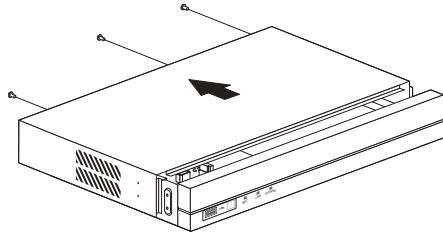

- 2 Connect the SATA/power cable of the hard disk to the connector of the main board.

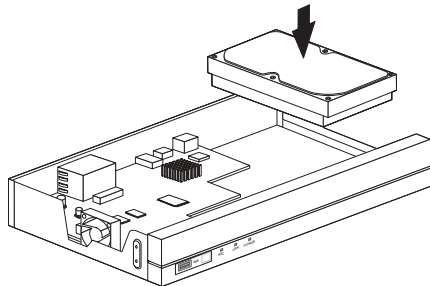

- ❗ ■ Gently press the connector before removing the HDD. Do not force to pull the cable.

- 3 Use the screws to fix the hard disk to the bottom of the recorder.

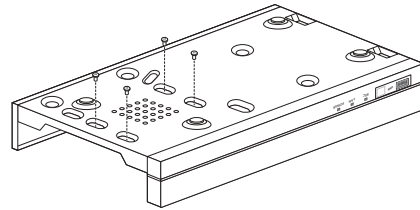

- 4 Make sure that there is no problem in the connection port and routing inside the recorder, and then fix it using screws after closing the cover.
  - When closing the cover, be careful not to damage the cable.

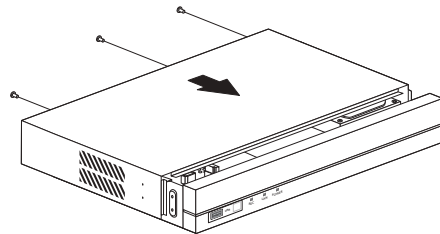

## Installation Wizard Setup

As shown below, proceed through each step of the <Installation wizard>. Install Wizard can only be accessed at factory reset. If you do not want to proceed, click <Exit>.

-  ■ You can set the install wizard on the recorder and web viewer. Refer to the User Manual for instructions on how to set up the install wizard on the web viewer.
- When you complete installation using the install wizard on your recorder, the install wizard will not appear on your web viewer.

### 1 Select the language

Select your preferred language.

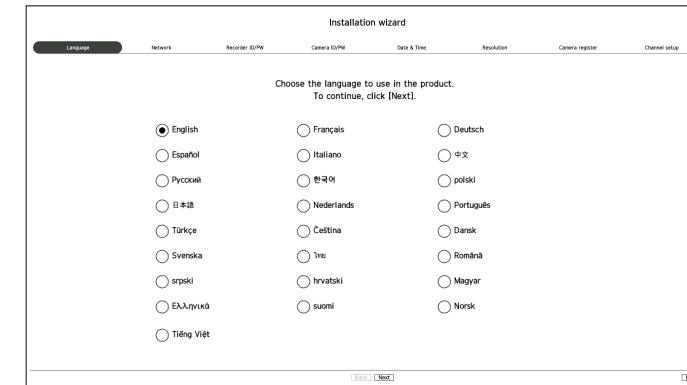

### 2 Network Settings

- DHCP server : If the DHCP server is set to enable, an IP is automatically assigned to the camera.
  - Network 1 (Camera) : Port for camera connections; it receives video from a camera.
  - Network 2 (All) : Network for a remote viewer (SSM, Smart Viewer, Webviewer)
  - Network 1 (Camera) / Network 2 (All) Setup
    - IP Type : Choose the network connection method.
    - IP Address, Subnet Mask, Gateway, DNS
  - Camera registration method : This function is only available for products that support PoE. For products that support PoE, see "Products supporting each feature" (Page 4) in the Product Specification Manual.
    - Enable PnP mode: Cameras connected to the PoE port of the product will automatically be registered for each channel in order of port number.
      - When the camera resets to factory default, it defaults to the ID and password set during the <Camera ID/PW> step.
      - If the camera's ID and password have already been set, the information that matches the ID and password set during the <Camera ID/PW> step will be registered (up to 3 sets).  
If your camera uses a manual IP, its bandwidth should match with that of Network 1 IP for registration.
      - If the PnP mode is not used, automatically detects and registers camera connected to the product's PoE port and camera with separate switch.
  - Enable online upgrade
    - You can receive a new firmware notification when the recorder is connected to a network.
- ※ For more details on network settings, refer to the User manual.
- ▶ To use a simple intranet, click <Next>.

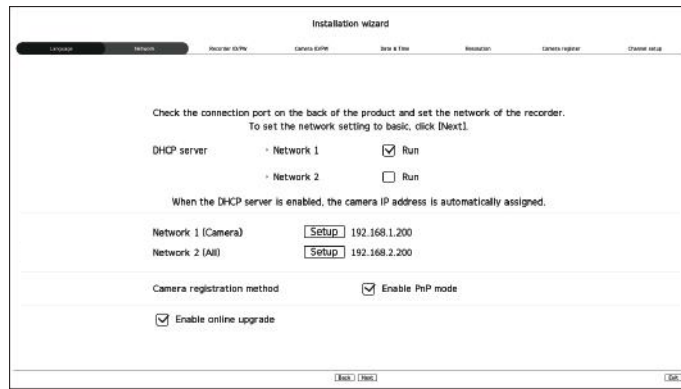

### 3 Recorder ID/PW Setup

Sets the administrator's password.

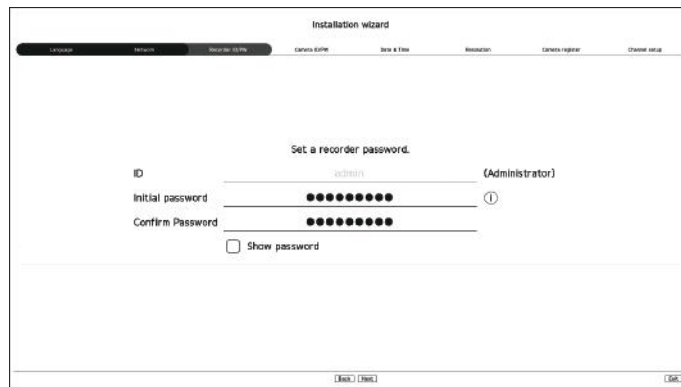

※ Click < i > to view the basic guide for setting a password. Refer to the password setup rules.

### 4 Camera ID/PW Setup

4-1. Set a camera password in factory reset. The initial password for the camera must be entered.

4-2. If ID/PW is already set in the camera, register the ID/PW and click <Next>.

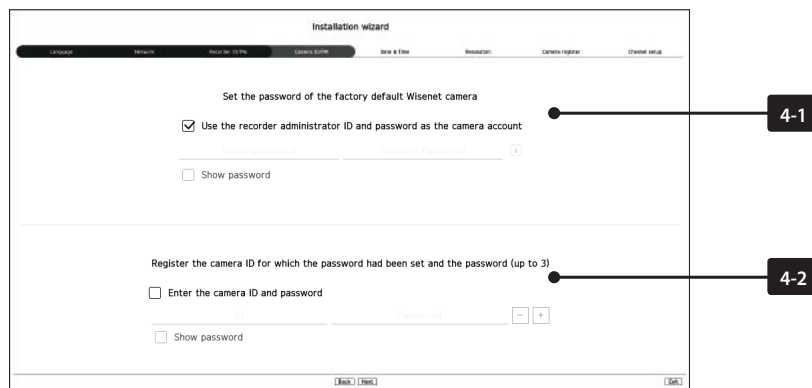

※ Click < i > to view the basic guide for setting a password. Refer to the password setup rules.

※ When the password is in factory reset, it can be changed and managed in a batch.

※ Up to 3 sets of camera ID with password and password can be registered.

※ You may change the passwords of registered cameras all at once in the “**Setup > Camera > Camera password**” menu.

※ You cannot change the password for cameras registered with ONVIF and RTSP.

### 5 Date & Time Setup

Set the date, time, time zone, and DST and then click <Next>.

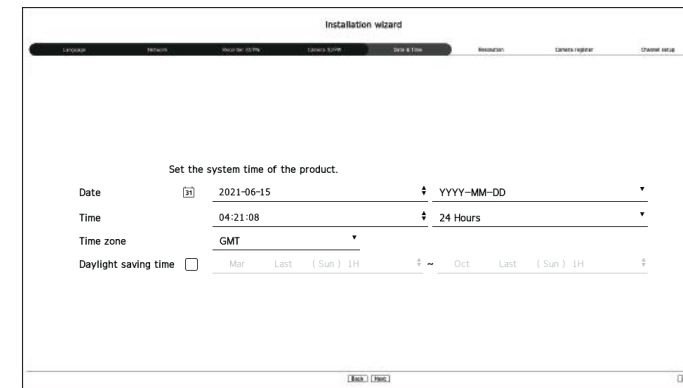

### 6 Resolution Setup

To set the recommended resolution, click <Apply> followed by the <Next> button.



## 7 Camera Register

Registers the searched network cameras.

**7-1** Select a camera to register from the searched camera list and click <Register>.

**7-2** Select a camera to register from the list and click <Change IP>.

**7-3** After completing camera register, click <Next>.

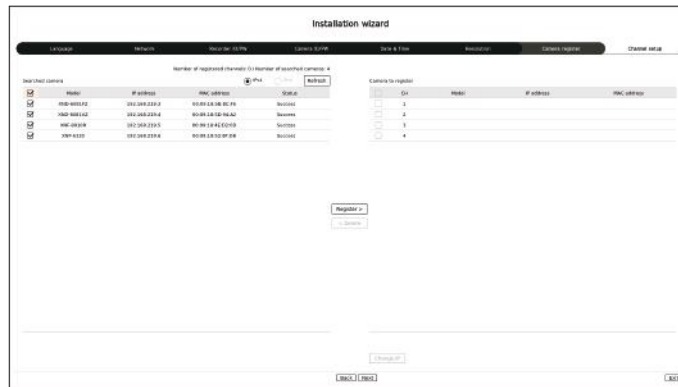

## 8 Channel Setting

You can view the camera videos registered to each channel in split mode along with thumbnail information. To change the camera video position, select a video and drag and drop it to the desired location.

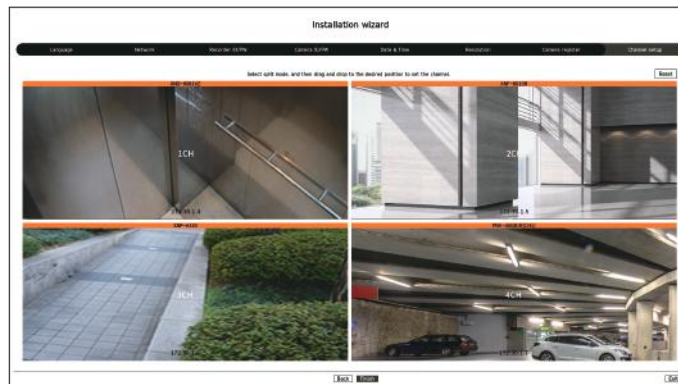

**9** Click <Finish> to complete the Install Wizard.

## Explore Screen Configuration

The recorder screen consists of the following.

The screen may be configured differently depending on the menu selected by the user.

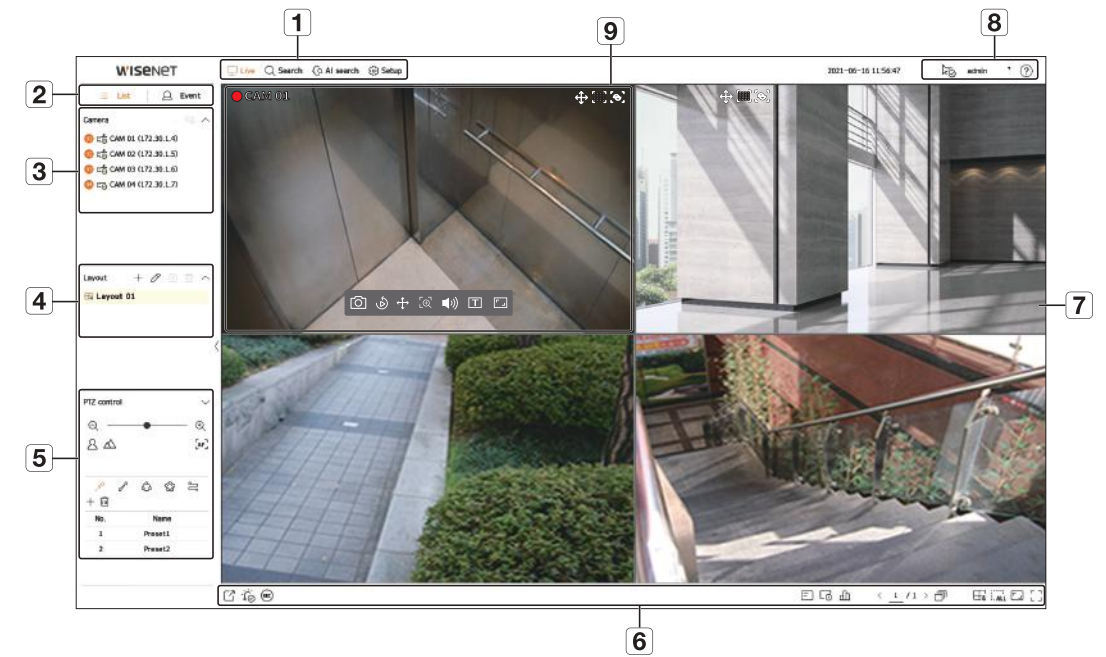

No.	Screen configuration	Detailed description of function
1	Menu	Clicking on each menu takes you to the corresponding menu screen.
2	List/Event	Select to view list of cameras or events.
3	Camera List	Click  List to display list of registered cameras in the recorder. You can also register the camera manually or automatically.
	Event List	Click  Event to display list of events.
4	Layout List	This displays a list of the default layouts and the layouts that have been created. You can set and play sequence on the list of layouts.
5	PTZ Control	Controls the connected PTZ camera.
6	Function buttons	Function that is frequently or urgently used. (export, alarm stop, manual recording, OSD display, channel information, check camera status, auto-switch screen, split mode setting, remove all tiles, change aspect ratio, switch to full screen mode)
7	Video window	Shows the video of the camera connected to the recorder.
8	Display system status and additional functions	<ul style="list-style-type: none"> <li>Displays the status of the system, hard disk, and network.</li> <li>The ID of the connected user is displayed.</li> <li>Displays a QR code to download User Manual.</li> </ul>
9	Display events and functions to control videos	Displays events that occurred on the device and functions related to video control.

## Record Setup

You can set resolution, FPS, and quality of recordings by channel, and by recording type of standard / event. You can check frame rates and data transfer amount of Full Frame and Key Frame recordings for each channel, and set the transfer limit for recordings.

### Setup > Record > Record setup

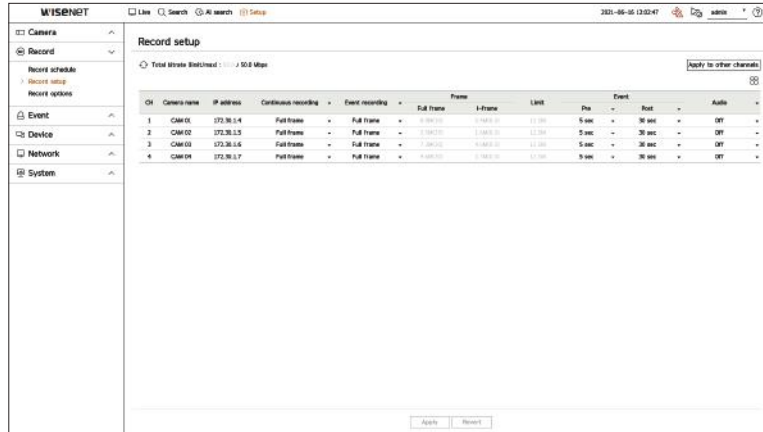

- Apply to other channels : If you select <Apply to other channels>, “Apply to other channels” confirmation window will appear. After selecting channels that the settings will be applied to, click on <OK> to apply them to the selected channels.
- : The camera of the corresponding channel is displayed on the list or as a thumbnail.
- Camera name : Displays the camera name.
- IP Address : Displays the camera IP address.
- Continuous recording / Event recording : Set the recording method for Continuous recording or Event recording.
  - Full frame : Records all frames fed by the camera.
  - I-frame : Records only key frames fed by the camera. Depends on camera settings.
  - Off : No recording is made.
- Frame
  - Full frame : Shows the amount of data for all the scene recordings.
  - I-frame : Shows the amount of data for the main scene recordings.
- Limit : Set the amount of data allowed for input for each channel.
- Event : When an event occurs, you can set which point you will start or stop recording.
  - Pre : When an event occurs, recording will be started regardless of the time set. If you set it to five seconds, recording will start at five seconds before an event occurs.
  - Post : When an event occurs, recording will continue after the time set. If you set it to five seconds, recording will continue for a further five seconds after an event is finished.
- Audio : Specify whether to record the sound received from the camera or not.



- If a channel's data transfer exceeds defined allowed limit, then it may affect to other channels, and may force switching to <I-frame> recording even when the channel is configured to <Full frame> recording mode. For Key Frame recording channels, the icon for limited recording appears on the live screen's top side. But if the sum of the limits is below the max limit, you can still receive the entire frames despite exceeding the permitted bitrates for each channel.
- A channel displayed in yellow indicates that the recorded data is not being transferred from the camera and that the recording is being performed temporarily using another profile on the camera. Check the channel information to see the applied profile to the channel listed in yellow. A channel displayed in orange indicates that the amount of inputted data is greater than the permitted data amount. In this case, it is impossible to record all of the incoming frames. Instead, only part of the frames (1 or 2 frames per second) can be recorded. To resolve this issue, you must set the permitted data amount to be greater than the amount of inputted data.

## Set up and Run the Layout

The layout set on the live screen can also be used for time search and can be searched and played according to the channel order and channel combination set by the user.



- For more information on how to set each step, refer to the 'User Manual'.

### 1 Live channel layout setup

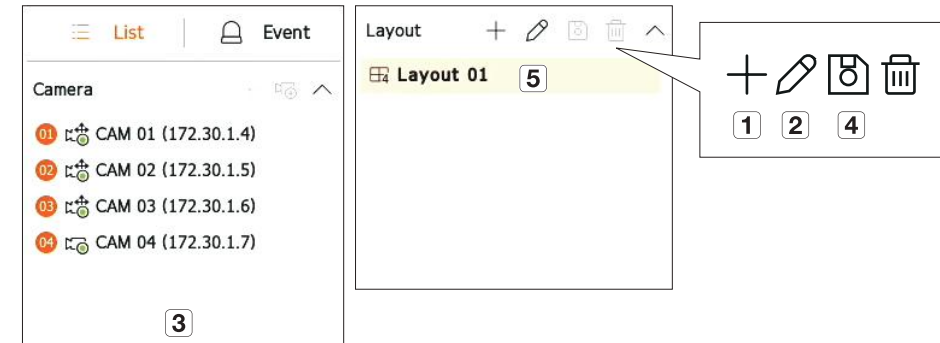

- 1 Add a layout.
- 2 Change layout name.
- 3 Click to select the channel to display on the layout of the device list.
- 4 Please save the layout you have set up.
- 5 Select a layout to move to the corresponding channel group.

### 2 Search/Play

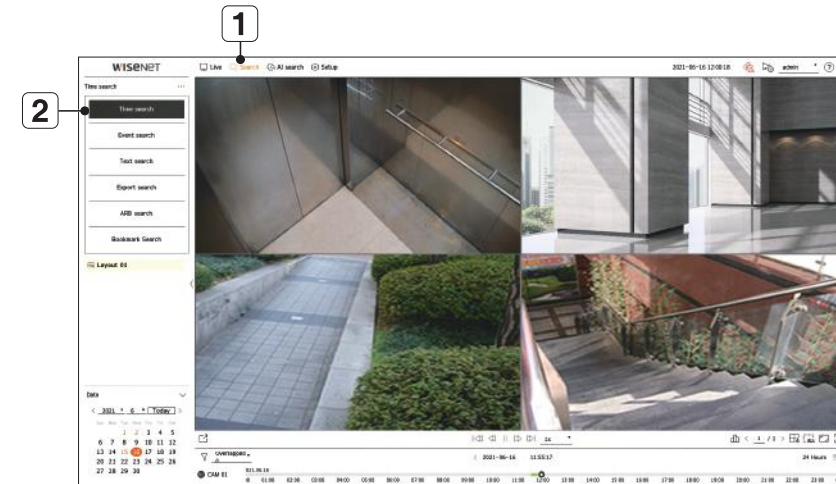

- 1 Click <Search> at the top of the screen.
- 2 Click <Time search>.

## 2-1 Search

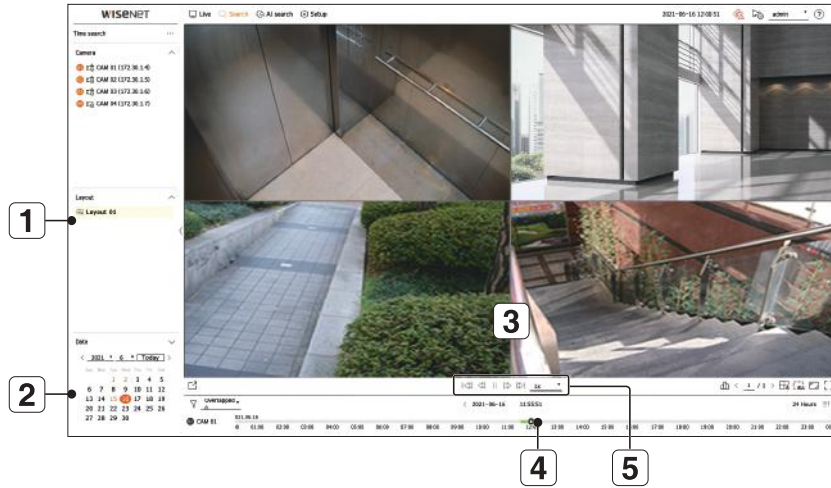

- 1 Select the layout of your choice from the channel groups you created in Live.
- 2 Please select a date to search.
- 3 Select the channel of your choice from the selected channel group.
- 4 You can view the preview screen on figure 3 by moving the time bar.
- 5 Press <▶> to play the selected channel.

## 2-2 Play

When you start playing, the search date and play time are displayed, and you can search for recorded videos while controlling the play speed.

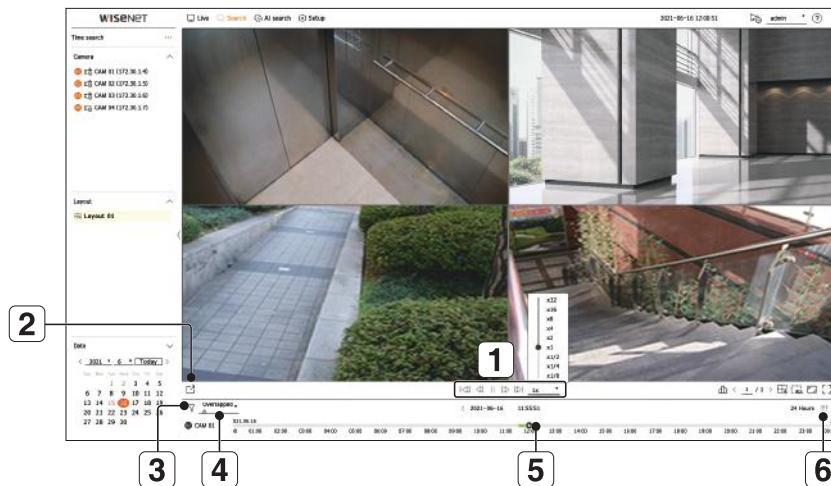

- 1 Control the play speed or move to the previous or next frame.
- 2 Export the recorded video of a designated time frame for each layout or channel.
- 3 Filter events by type to search for recorded videos.
- 4 Set the overlapping section according to change of time to check the time line.
- 5 Display the time line for each channel.
- 6 Open or close the 4-channel time line.

## 3 Export recorded video



- 1 Click <⏪> at the bottom of the screen.
- 2 Select a layout.
- 3 Select a channel.
- 4 Set the time, device, and format for export.
- 5 Click the <Check capacity> button to see if you can export.
- 6 Click the <Start> button to proceed with the export.

## Using Product Information

You can check the product information/manual/firmware information/FAQ/HDD compatibility list on the homepage or mobile web of your smartphone.

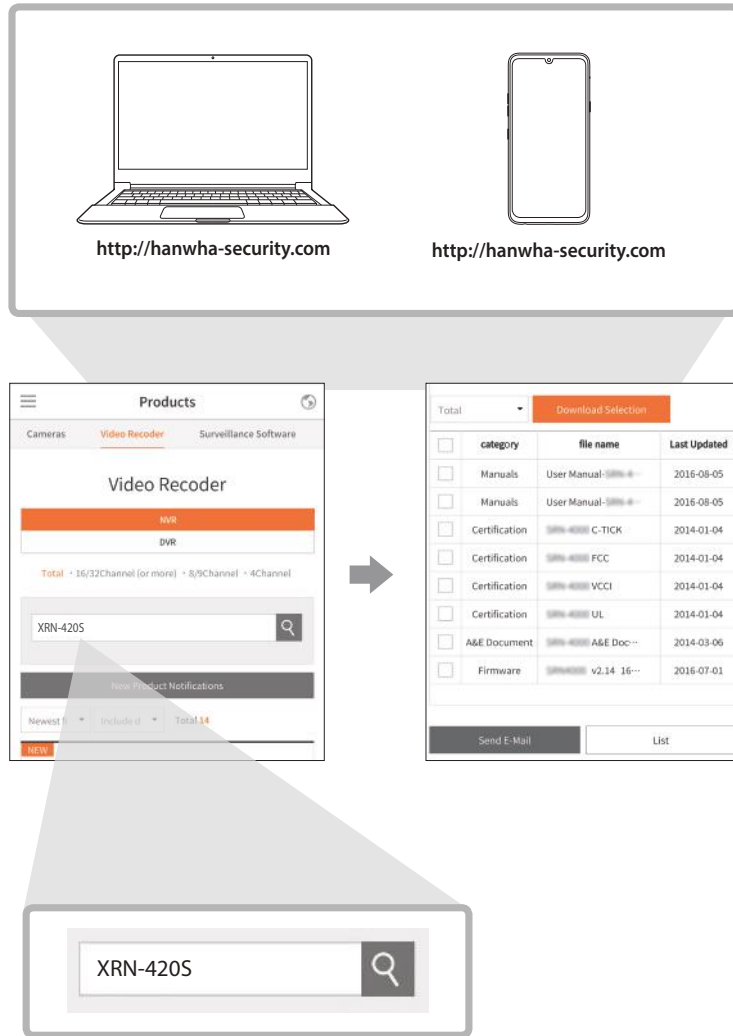

## Using P2P Service

This function is available only for products that support P2P. To find products that support P2P, see 'Products supporting each feature (Page 4)' of the Product Specification Manual.

When using a P2P service, you can easily access and use with Wisenet mobile.

- 1 Click <Enable P2P> to test the connection to see if the current recorder can be connected remotely. The product is displayed on the list.

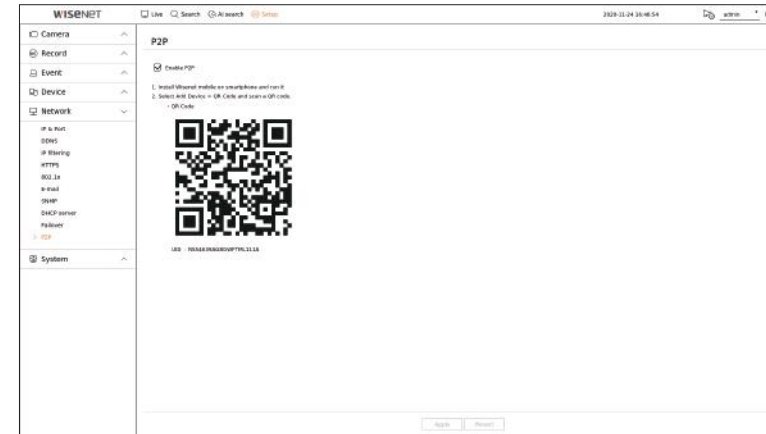

- 2 If the connection is successful, search for Wisenet mobile on your smartphone and install and run it.
  - You can scan the QR code on the recorder by selecting Add device> QR code.
- 3 When the QR code is scanned, the UID that can be seen in recorder is automatically converted to mobile viewer, and the mobile viewer can be used right away when the recorder ID and password are entered.

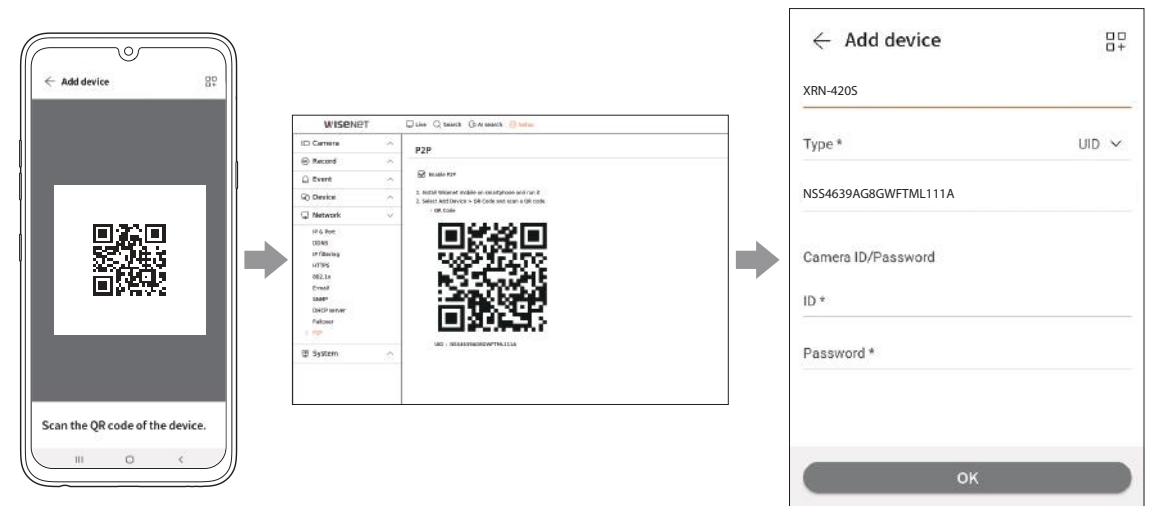



- 4 From now on, when you run the WiseNet mobile application saved to your smartphone, you can easily monitor with your smartphone as you are automatically connected to the recorder.

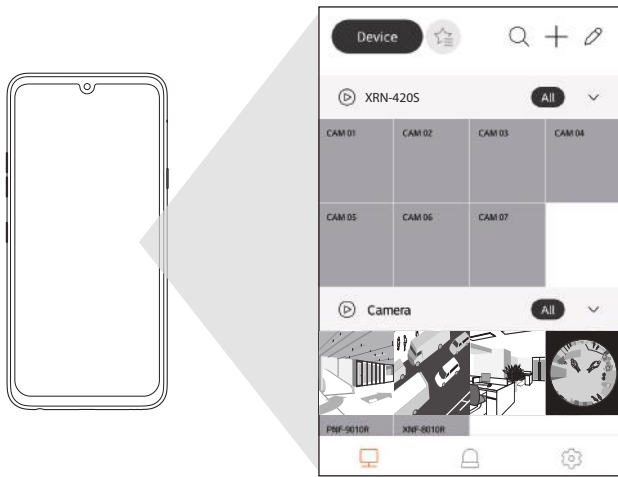

- The P2P service period expires in 3 years. If you want to extend it after expiration, contact your vendor.

## Connecting to a Network Using a Router

If you want to add 1-3 PCs and recorders in an environment using xDSL/Cable modem, you can use the router with only one Internet line.

This guide is an installation guide for network beginners. Follow the instructions to set up your router, local PC, and recorder.

### Connecting the cable

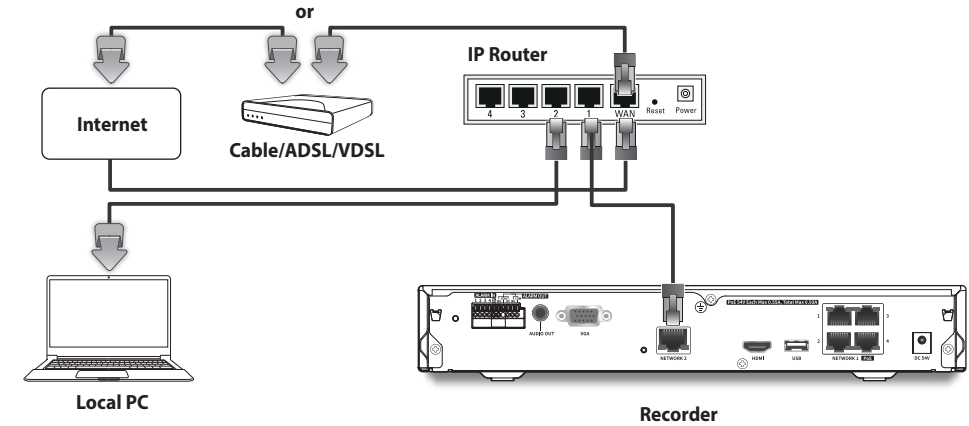

### Connecting a router with PC

- Refer to the router's user manual.

### Connecting a recorder and a router

Move to **<IP & Port>** of the Recorder **<Network>** Setting menu, and set the **1 <IP address>** and **2 <Gateway>** in **<Setup>**.

※ The **<Default gateway>** checked on the **[cmd.exe]** window of the local PC and the **<Gateway>** of the recorder must be the same.

※ At least the third number of the recorder **<IP address>** should be set to be the same as the **<Default gateway>** checked on the **[cmd.exe]** window of the local PC.

```

C:\Users\Users>ipconfig

Windows IP Configuration

Ethernet adapter Ethernet 2:

    Connection-specific DNS Suffix  . : kornet
    Link-local IPv6 Address . . . . . : fe80::860c:890c:7718:8425%18
    IPv4 Address. . . . . : 192.168.219.192
    Subnet Mask . . . . . : 255.255.255.0
    Default Gateway . . . . . : 192.168.219.1
  
```

<cmd screen>

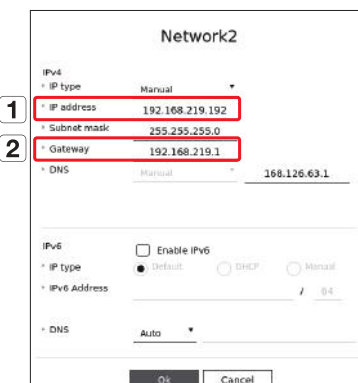

<ex. Recorder screen>

## Checking the recorder connection from the PC

Enter the IP set in the recorder menu in the local PC address bar. Once you log in by entering your user name and password, the recorder's web viewer screen appears.

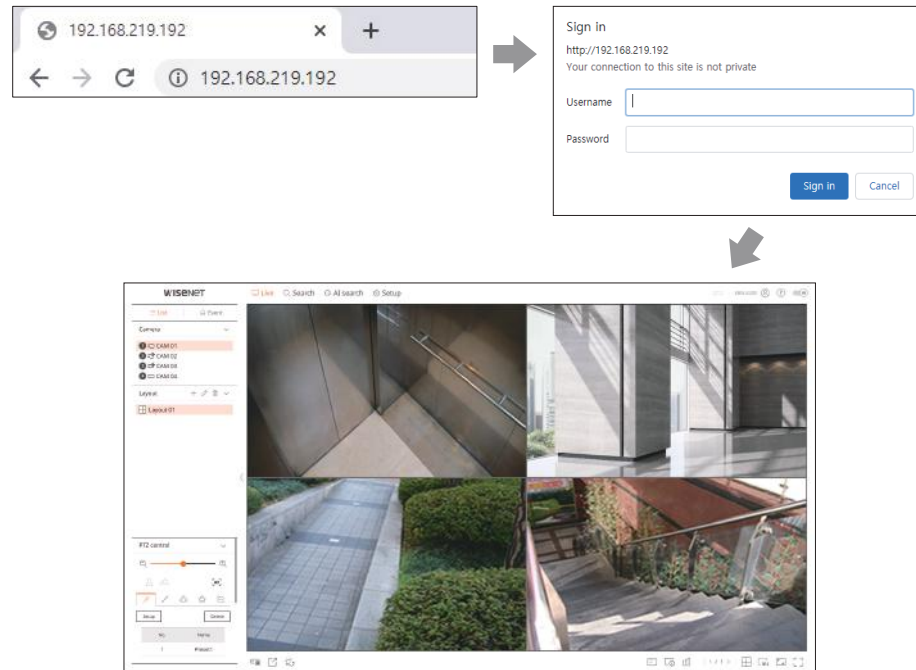

## System requirements

The following lists the minimum suggested hardware and operating system requirements needed to run the Web Viewer.

- Use the browser recommended by the OS.  
Ex.) Microsoft recommended browser: Microsoft Edge
- Supported browsers : Chrome, Edge, and Safari
- Supported OS : Works on all of the Windows, Linux, and OS X environments given the platform-independent nature of the web.
- Tested environments : Tested and certified to run on Windows® 10 with Edge 91, Google Chrome™ 91 and Intel® Core™ i7-7700 processor 3.60 Ghz with NVIDIA® GeForce® GTX™ 1050 or Intel™ HD Graphics 630.
- Performance restrictions : The performance of users' CPU/GPU may impact the video playback performance of the web viewer. The video quality may decrease depending on the settings, such as high resolution or transfer bandwidth, when playing H.265 video in Chrome.

## Router and Internet connection setup

Since each router has a different connection method, check the settings for each router.

### Port forwarding on the router setup

Set up the router's port forwarding to connect to a PC or a recorder connected to the router's local LAN from outside.

The recorder uses the <RTSP port>, <HTTP port>, <HTTPS port>, and camera proxy ports. You must set up port forwarding for all the ports you use.

- ※ If only <HTTP port> is set for port forwarding, <RTSP port>, which is a video transmission port, is connected, but no video is displayed.
- ※ If only <RTSP port> is set for port forwarding, no connection is available because <HTTP port>, which is a web connection port, is connected.
- ※ Refer to the router's user manual.

## Accessing using DDNS address in the dynamic IP environment

In the dynamic IP environment such as xDSL/Cable modem, the router's WAN IP can be changed, so we provide DDNS (Dynamic Domain Name Server) service so that you can always access the recorder with only the DDNS address even in the dynamic IP environment.

### Wisenet DDNS Setup

Since you will be accessing the recorder remotely, set up a Wisenet DDNS account first using a PC.

- 1 Open a browser, go to [ddns.hanwha-security.com](https://ddns.hanwha-security.com), and click <Login>.



- 2 Click <Sign Up>.



- 1 Follow the instructions to register an account on the website.
- 2 Log in after completing account registration.

- 3 Click <Register Product> tab to add a recorder to your account.

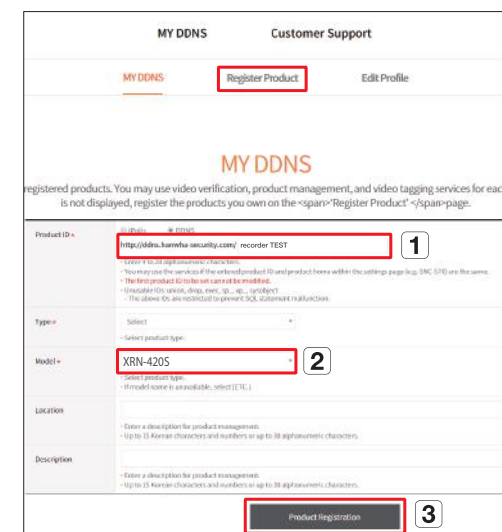

- 1 Create a name for your recorder (product ID).
- 2 Select the type of recorder and model name.
- 3 Click <Product Registration>.

- 4 After registration, your product will appear in the list.

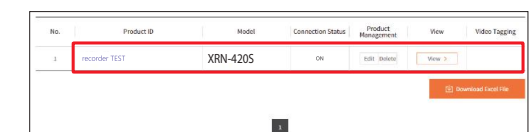

## Connect using DDNS address

- 1 Select DDNS site on the recorder setup menu and enter the product ID.



- 1 Select <ddns.hanwha-security.com> on the <Server> on the <Network> menu.
- 2 Enter the product ID generated on the Wisenet DDNS website for <Product ID>.
- 3 When the DDNS setup is finished, select <Apply>.
- 3 You can connect to the recorder by entering the DDNS host address, **http://ddns.hanwha-security.com/recorder TEST**, on a local PC website address bar.  
You can also click < View > in item 2 to connect to the recorder.

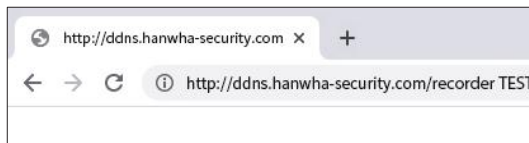

All settings are complete.

If you remember your DDNS address and ID / password, you can access the recorder from any PC with an Internet connection.

For more information, refer to the user manual.

- 2 Connect to [ddns.hanwha-security.com](http://ddns.hanwha-security.com) and check if the connection status of the registered product is set to <ON>.

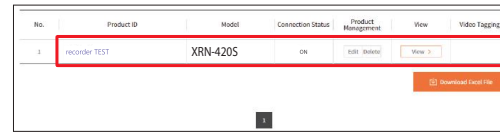

< Wisenet DDNS Setup screen >

- 4 The web viewer screen of the recorder appears.

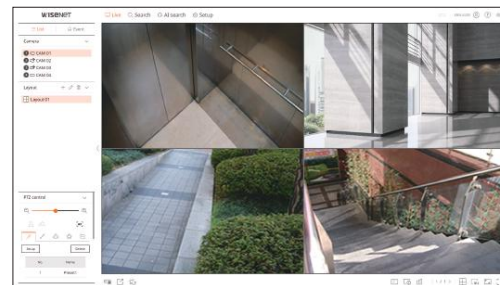



Hanwha Techwin cares for the environment at all product manufacturing stages, and is taking measures to provide customers with more environmentally friendly products.  
The Eco mark represents Hanwha Techwin's devotion to creating environmentally friendly products, and indicates that the product satisfies the EU RoHS Directive.



**Correct Disposal of This Product** (Waste Electrical & Electronic Equipment)

(Applicable in the European Union and other European countries with separate collection systems)

This marking on the product, accessories or literature indicates that the product and its electronic accessories (e.g. charger, headset, USB cable) should not be disposed of with other household waste at the end of their working life. To prevent possible harm to the environment or human health from uncontrolled waste disposal, please separate these items from other types of waste and recycle them responsibly to promote the sustainable reuse of material resources.

Household users should contact either the retailer where they purchased this product, or their local government office, for details of where and how they can take these items for environmentally safe recycling.

Business users should contact their supplier and check the terms and conditions of the purchase contract. This product and its electronic accessories should not be mixed with other commercial wastes for disposal.



**Correct disposal of batteries in this product**

(Applicable in the European Union and other European countries with separate battery return systems.)

This marking on the battery, manual or packaging indicates that the batteries in this product should not be disposed of with other household waste at the end of their working life. Where marked, the chemical symbols Hg, Cd or Pb indicate that the battery contains mercury, cadmium or lead above the reference levels in EC Directive 2006/66. If batteries are not properly disposed of, these substances can cause harm to human health or the environment.

To protect natural resources and to promote material reuse, please separate batteries from other types of waste and recycle them through your local, free battery return system.

