

WISENET

MOBILE VIDEO RECORDER









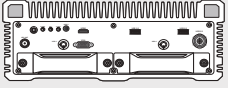

Quick Manual

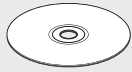
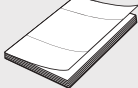
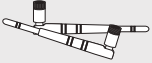
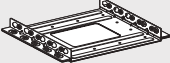
CE





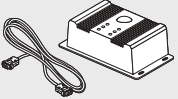



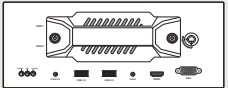

Package Contents

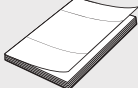
- The appearance of the components may differ from the image shown.
- Accessory category and quantity may differ depending on sales region.

TRM-1610S/1610M

			
NVR	Power cable	User Manual CD	User Manual or Quick Manual
			
Wi-Fi antenna	Mounting bracket	Screw for bracket assembly	Mounting screws
			
HDD fixing screws	HDD lock key	M12 to USB cable	GPS antenna
			
Control box / Control box connection cable	Alarm cable		

TRM-410S/810S/810M

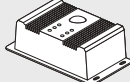
			
NVR	Power cable	User Manual CD	User Manual or Quick Manual
			
Wi-Fi antenna	Mounting bracket	Screw for bracket assembly	Mounting screws
			
HDD fixing screws	HDD lock key	GPS Module	Control box

How to install the product

- The images below are based on the TRM-1610S model.

- Remove the mounting bracket and side brackets.
- Tighten the side brackets to the body.

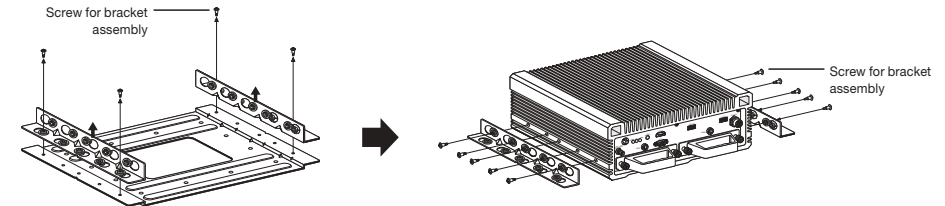

- Install the mounting bracket at the installation site.
- Install the main body with the side brackets in the bracket installed in Step 3.

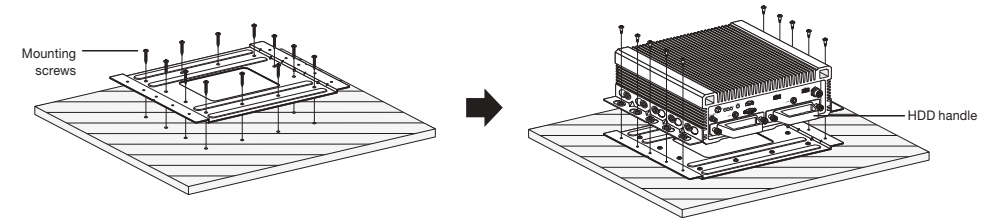

- Be sure to observe the work procedure (1 - 4) when installing the product, and pay attention to potential accidents caused by the product falling.
- When moving the set, do not move it while holding the HDD handle.

How to install the control box

- The images below are based on the TRM-1610S model.

Assemble mounting screws and install the camera on a wall/floor/ceiling as shown in the figure. Connect to the main unit via the control box connection cable.

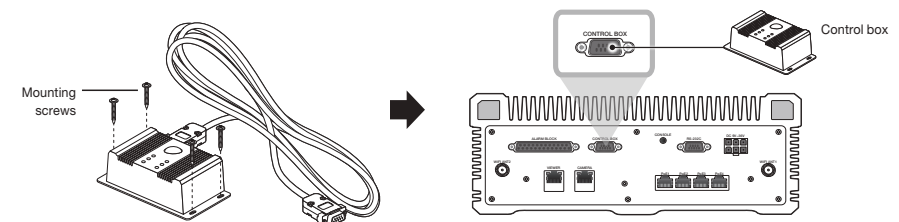

Installing the HDD

 The images below are based on the TRM-1610S model.

TRM-1610S/TRM-1610M

- 1 Unscrew the HDD bracket fixing screws on the front of the set and pull it to the front to separate the HDD.
 - If the lock on the front is locked, open the lock using the key that was provided when you purchased the product.

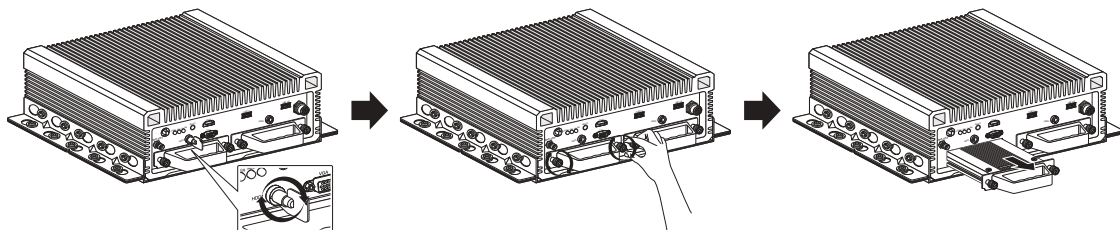

- 2 Loosen the screws on the front/rear of the bracket and separate the bracket.
- 3 After replacing/installing the HDD, fix the HDD and bracket with screws.

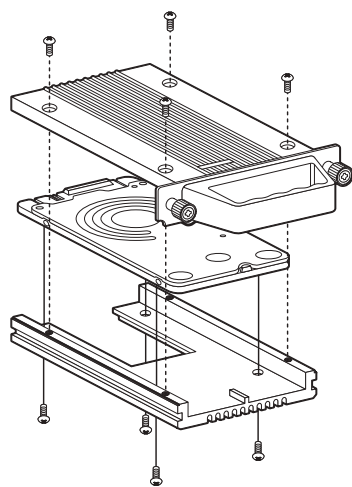

- 4 Slide the bracket with the HDD into the main body, and tighten the screws to fix it.

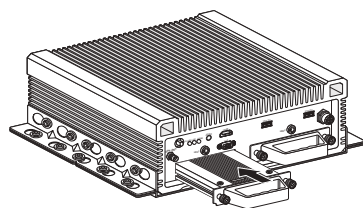

-  If you are adding a new or previously used HDD to this product in addition to the HDD(s) originally installed, format the new HDD manually in the set before use.
- For replacement or installation of an additional HDD you must contact your dealer or our customer center.

TRM-810S/TRM-810M/TRM-410S

 The images below are based on the TRM-810S model.

- 1 Unscrew the HDD bracket fixing screws on the front of the set and pull it to the front to separate the HDD.
 - If the lock on the front is locked, open the lock using the key that was provided when you purchased the product.

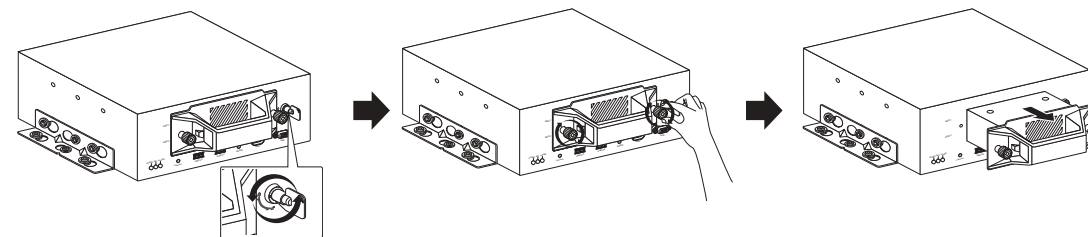

- 2 Remove the screws from the bracket to separate the bracket.

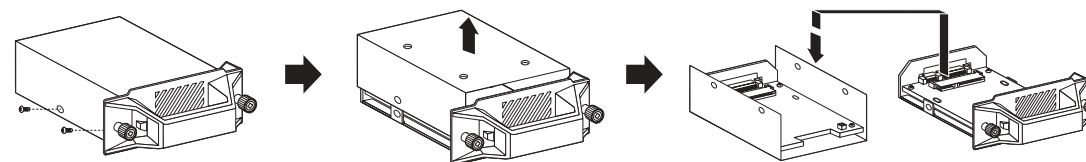

- 3 After replacing/installing the HDD, fix the HDD and bracket with screws.

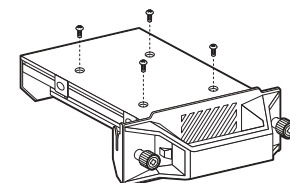
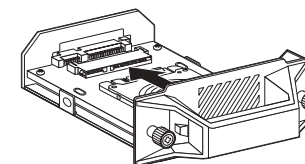
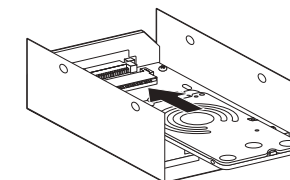

- 4 Slide the bracket with the HDD into the main body, and tighten the screws to fix it.

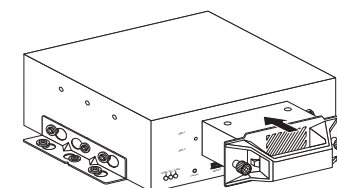

-  Make sure to properly place the fan connector when installing HDD.

Install Wizard

1 Select the language

Select your preferred language.

2 Set Password

Set a password.

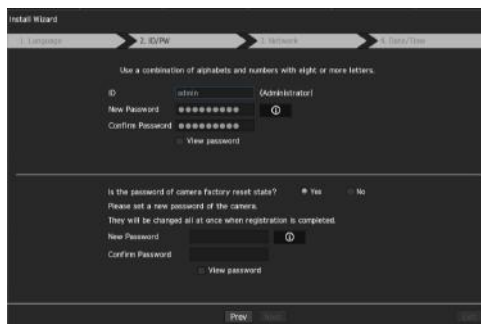

※ Click  icon to see the password rule. Check the password setting rules.

2-1. Setting Camera Password

You can change the password of the camera one step.

If the password of the camera is the default password set in the factory, enter a new password to change it. The password will be changed, and the new password will be registered.

If the password of the camera is not the default password set in the factory, enter the current camera password. The current camera password will be registered.

- New Password : Input a new password according to the password setting rules.
- Confirm Password : Input the new password again.
- A camera password registered with ONVIF and RTSP cannot be changed.

3 Set up Network

- DHCP server : If the DHCP server is set to enable, an IP is automatically assigned to the camera.
- Network 1 : Connects to the camera and receives the video feed from the camera.
- Network 2 : This is a port for transmitting an image to the webviewer.
- Wi-Fi : Port for connecting to external Wi-Fi. The Wi-Fi port is used for backup.
- Network 1 / Network 2 Setup
 - IP Type : Choose the network connection method.
 - IP Address, Subnet Mask, Gateway, DNS
 - Wi-Fi can be set after the installation wizard has been closed.

※ For more details on network settings, refer to the User manual.

▶ To use a simple intranet, click **<Next>**.

- Switch Mode : Set the camera registration method. This function is only available for products with PoE support.

For products with PoE support, see “**NVR products supporting each feature**”. (Page 4)

- PnP Mode : Camera connected to the PoE port of the product will be registered automatically on each channel in the order of the port number. This works only when camera is in factory reset state.
- Manual Setup Mode : Automatically scans and registers camera connected to the product's PoE and camera with separate switch.



4 Set Date & Time

Set the time and date and click the **<Finish>** button, and the installation will be completed.

5 Camera Registration

In the setting completion window, click on the **<OK>** button to finish camera setting and launch the camera registration screen.

5-1. Cameras connected to the PoE port are automatically registered and displayed in the camera registration list. Select the cameras to be registered from the list of cameras, and click the **<Register>** button.

- ▶ The camera may not be shown in the list if there is no response from the camera. You can re-import the list by pressing the **<Refresh>** button.

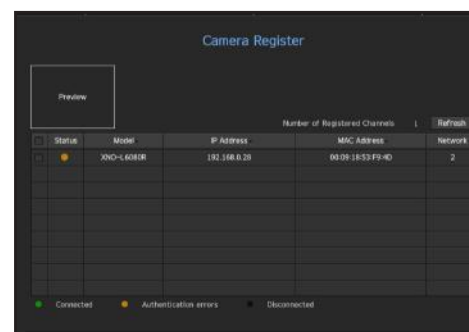

5-2. When camera registration is finished, the frame rate of the set recording profile is displayed. After you click the **<Manual Setup>** button, you can modify the frame rate value.

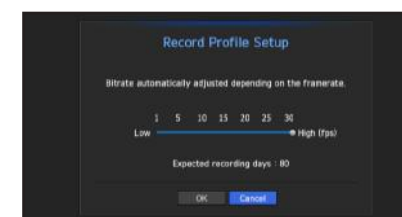
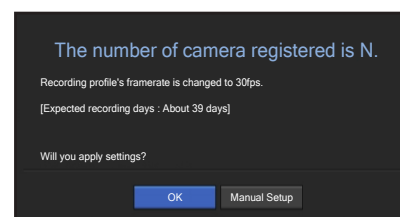

Configure and run layout

You can use the same layout set on the live screen for the Search Time function in order to perform a search using the channel sequence and combination configured by the user.

- For more information about the detailed setting method for each stage, refer to the user manual.

1 Live channel layout settings

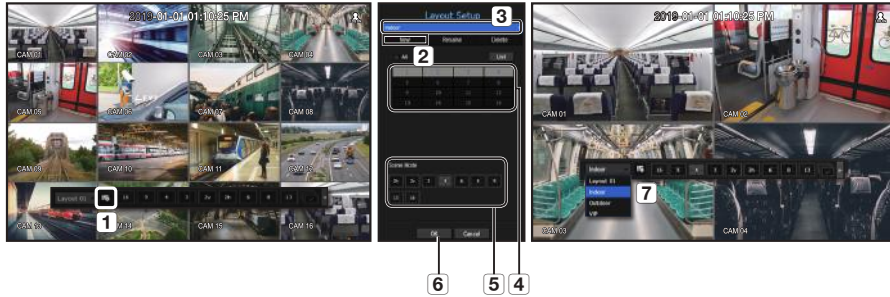

- Open the channel layout setup menu.
- Click <New>.
- Enter a name for the selected channels (e.g., Indoor).
- Select the channels that you want to add to the layout (e.g., 1, 2, 3, 4).
- Choose a split mode to apply (e.g., 4-way split).
- Click <OK>.
- Choose a layout to view it on the screen (e.g., change to Indoor).

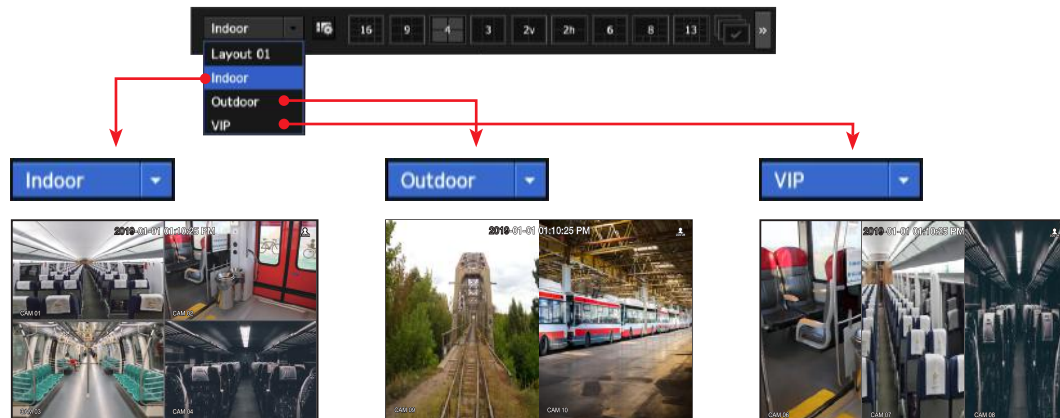

2 Search/Play

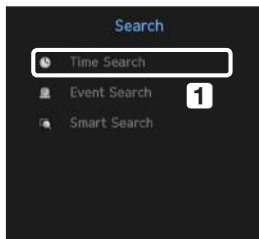

- In live mode, right-click to select <Search>. Select <Time Search>.

2-1 Search

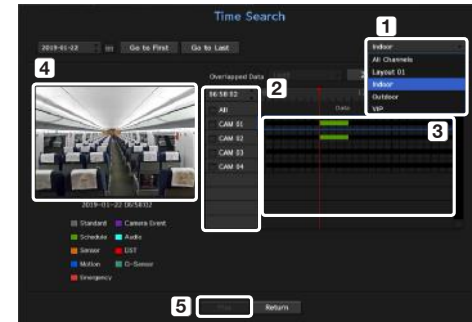

- The initial search option is set to <All Channels>. Select a desired layout from among the channel group created in the live screen.
- Select a channel for each selected group.
- Move the time bar to view the preview screen as shown in Figure 4.
- Press the <Play> button to enter the play screen.

2-2 Play

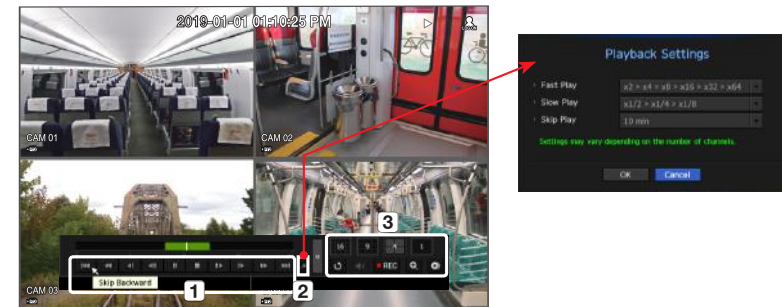

- These are the various functions available for playback. Hover over them and a tool tip will be prompted. Control the playback by referring to the tool tip. (Ex : Skip Backward)
- You can configure specific functions in 1 through playback settings. Ex) Jump to play: 10 minutes, 30 minutes, 1 hour, 24 hours, etc.
- Displays functions that are operating in split mode and during other playback.

3 Backup

Right-click on the live screen and select <Backup>.

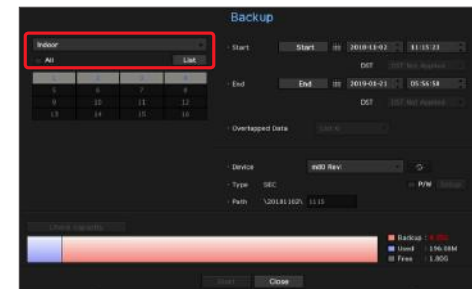



- Select a layout.
- Select a channel.
- Set the time, device, and format to back up.
- Click the <Check capacity> button to check if backup is possible.
- Click the <Start> button to proceed with the backup.

Use the basic guide

Show shortcut menu

Right-click on the live screen and you can access various functions that NVR provides. Hover over an icon and a brief definition of term for each function is prompted.

- Layout ▶
- Layout Setup ▶
- Keep ch. scr ratio ▶
- Status ▶
- PTZ ▶
- ZOOM ●
- Audio ▶
- Freeze ▶
- Stop Alarm ▶
- Capture ▶
- Record ▶
- Play ▶
- Search ▶
- Backup ▶
- Menu ●
- Shutdown ▶
- Logout ▶
- Hide Launcher ▶

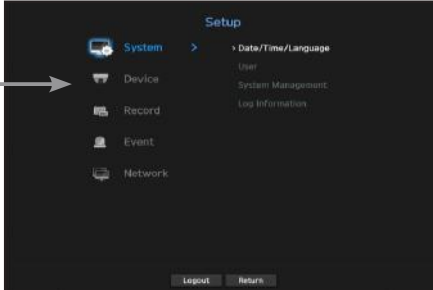
Live launcher

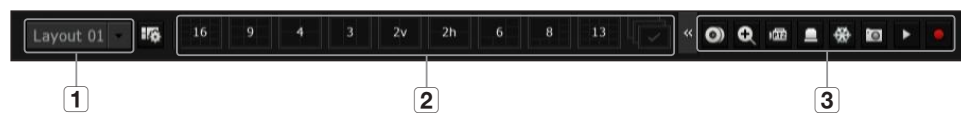

- 1 You can configure a live layout.
- 2 You can configure a supported split mode. You can view the end sequence () in serial order for a specific period of time for each split mode.
- 3 You can configure additional functions in the live screen, such as alarm control or audio.

Use product information

You can check product information/user manual/firmware information/FAQ/HDD compatibility list, etc. on the website or mobile app on your smartphone.

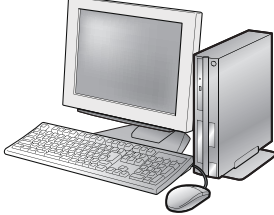

<http://hanwha-security.com>



<http://hanwha-security.com>

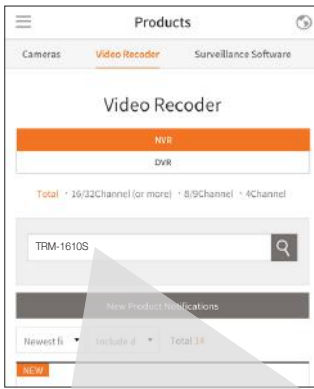
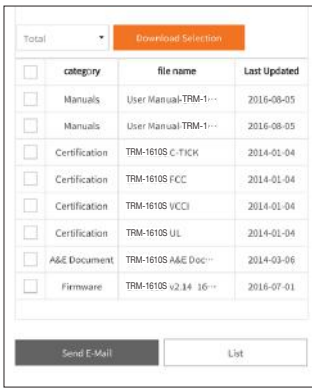

Hanwha Techwin cares for the environment at all product manufacturing stages, and is taking measures to provide customers with more environmentally friendly products.

The Eco mark represents Hanwha Techwin's devotion to creating environmentally friendly products, and indicates that the product satisfies the EU RoHS Directive.



Correct Disposal of This Product (Waste Electrical & Electronic Equipment)

(Applicable in the European Union and other European countries with separate collection systems)

This marking on the product, accessories or literature indicates that the product and its electronic accessories (e.g. charger, headset, USB cable) should not be disposed of with other household waste at the end of their working life. To prevent possible harm to the environment or human health from uncontrolled waste disposal, please separate these items from other types of waste and recycle them responsibly to promote the sustainable reuse of material resources.

Household users should contact either the retailer where they purchased this product, or their local government office, for details of where and how they can take these items for environmentally safe recycling.

Business users should contact their supplier and check the terms and conditions of the purchase contract. This product and its electronic accessories should not be mixed with other commercial wastes for disposal.



Correct disposal of batteries in this product

(Applicable in the European Union and other European countries with separate battery return systems.)

This marking on the battery, manual or packaging indicates that the batteries in this product should not be disposed of with other household waste at the end of their working life. Where marked, the chemical symbols Hg, Cd or Pb indicate that the battery contains mercury, cadmium or lead above the reference levels in EC Directive 2006/66. If batteries are not properly disposed of, these substances can cause harm to human health or the environment.

To protect natural resources and to promote material reuse, please separate batteries from other types of waste and recycle them through your local, free battery return system.

Head Office

6, Pangyo-ro 319 beon-gil, Bundang-gu, Seongnam-si,
Gyeonggi-do, 463-400 Rep. of KOREA
Tel : +82.70.7147.8753 Fax : +82.31.8018.3740
<http://hanwha-security.com>

Hanwha Techwin America

500 Frank W. Burr Blvd. Suite 43 Teaneck, NJ 07666
Toll Free : +1.877.213.1222 Direct : +1.201.325.6920
Fax : +1.201.373.0124
www.hanwhasecurity.com

Hanwha Techwin Europe

Heriot House, Heriot Road, Chertsey, Surrey, KT16 9DT, United Kingdom
Tel : +44.1932.57.8100 Fax : +44.1932.57.8101
www.hanwha-security.eu

Hanwha Techwin(Tianjin) Co.Ltd

No.11, Weiliu Rd., Micro-Electronic Industrial Park, Jingang Road Tianjin 300385, China
Tel : +86.22.2388.7788
www.hanwha-security.cn

Hanwha Techwin Middle East FZE

JAFZA View 18, 20th floor, office 2001, 2002, 2003, Downtown Jebel Ali,
Dubai, United Arab Emirates
<http://hanwha-security.com>
