

WISENET

MOBILE VIDEO RECORDER

User Manual

CE

Mobile Video Recorder

User Manual

Copyright

©2019 Hanwha Techwin Co., Ltd. All rights reserved.

Trademark

Each of trademarks herein is registered. The name of this product and other trademarks mentioned in this manual are the registered trademark of their respective company.

Restriction

Copyright of this document is reserved. Under no circumstances, this document shall be reproduced, distributed or changed, partially or wholly, without formal authorization.

Disclaimer

Hanwha Techwin makes the best to verify the integrity and correctness of the contents in this document, but no formal guarantee shall be provided. Use of this document and the subsequent results shall be entirely on the user's own responsibility. Hanwha Techwin reserves the right to change the contents of this document without prior notice.

❖ Design and specifications are subject to change without prior notice.

You can download the latest version from the Hanwha Techwin web site. (www.hanwha-security.com)

❖ The initial administrator ID is "admin" and the password should be set when logging in for the first time.

Please change your password every three months to safely protect personal information and to prevent the damage of the information theft.

Please, take note that it's a user's responsibility for the security and any other problems caused by mismanaging a password.

IMPORTANT SAFETY INSTRUCTIONS



Read these operating instructions carefully before using the unit.
Follow all the safety instructions listed below.
Keep these operating instructions handy for future reference.

- 1) Read these instructions.
- 2) Keep these instructions.
- 3) Heed all warnings.
- 4) Follow all instructions.
- 5) Do not use this apparatus near water.
- 6) Clean the contaminated area on the product surface with a soft, dry cloth or a damp cloth. (Do not use a detergent or cosmetic products that contain alcohol, solvents or surfactants or oil constituents as they may deform or cause damage to the product.)
- 7) Do not block any ventilation openings, Install in accordance with the manufacturer's instructions.
- 8) Do not install near any heat sources such as radiators, heat registers, stoves, or other apparatus (including amplifiers) that produce heat.
- 9) Do not defeat the safety purpose of the polarized or grounding- type plug. A polarized plug has two blades with one wider than the other. A grounding type plug has two blades and a third grounding prong. The wide blade or the third prong are provided for your safety. if the provided plug does not fit into your outlet, consult an electrician for replacement of the obsolete outlet.
- 10) Protect the power cord from being walked on or pinched particularly at plugs, convenience receptacles, and the point where they exit from the apparatus.
- 11) Only use attachments/accessories specified by the manufacturer.
- 12) Use only with the cart, stand, tripod, bracket, or table specified by the manufacturer, or sold with the apparatus. When a cart is used, use caution when moving the cart/ apparatus combination to avoid injury from tip-over.
- 13) Unplug this apparatus during lightning storms or when unused for long periods of time.
- 14) Refer all servicing to qualified service personnel. Servicing is required when the apparatus has been damaged in any way, such as power-supply cord or plug is damaged, liquid has been spilled or objects have fallen into the apparatus, the apparatus has been exposed to rain or moisture, does not operate normally, or has been dropped.



Standards Approvals



-  Any changes or modifications in construction of this device which are not expressly approved by the party responsible for compliance could void the user's authority to operate the equipment.
-  This device complies with part 15 of the FCC Rules. Operation is subject to the following two conditions: (1) This device may not cause harmful interference, and (2) this device must accept any interference received, including interference that may cause undesired operation.
-  This equipment has been tested and found to comply with the limits for a Class A digital device, pursuant to part 15 of the FCC Rules. These limits are designed to provide reasonable protection against harmful interference when the equipment is operated in a commercial environment. This equipment generates, uses, and can radiate radio frequency energy and, if not installed and used in accordance with the instruction manual, may cause harmful interference to radio communications. Operation of this equipment in a residential area is likely to cause harmful interference in which case the user will be required to correct the interference at his own expense.

PRODUCT USER MANUAL DESCRIPTION

This document is a product user manual for mobile NVR. Before using this product, please read this document carefully in order to use it properly.

- This user manual explains how to use the product based on the defaults and default screens of this product.
- The content of this manual is subject to change depending on the product software updates and the company policies. It is subject to partial changes without prior notification to users.

TARGET AUDIENCE

This user manual contains contents for mobile NVR users.

HOW TO USE THE PRODUCT

Users of this product can perform the following:

- How to monitor the camera on the mobile NVR in real time
- How to search for or play back video recording on the mobile NVR
- How to monitor real time events or search logs from the mobile NVR, its sensor and camera

Before using this product, check if the latest version of this software is installed. Go to Hanwha Techwin's website (<http://www.hanwha-security.com>) to check the software version and download necessary files.

CONTENTS

| | | |
|-----------------|----------|---------------------------------|
| OVERVIEW | 3 | Important Safety Instructions |
| | 3 | Product User Manual Description |
| | 3 | Target Audience |
| | 3 | How to Use the Product |
| | 4 | Contents |

3

| | | |
|-------------|-----------|---------------------------|
| LIVE | 5 | Getting Started |
| | 7 | Live Screen Configuration |
| | 11 | Live Screen Mode |
| | 12 | Status |
| | 14 | Zoom |
| | 15 | Layout |
| | 15 | Audio ON/OFF |
| | 15 | Freeze |
| | 16 | Event Monitoring |
| | 16 | Capture |
| | 17 | Maintain the Screen Ratio |
| | 17 | PTZ control |
| | 19 | Backup |

5

| | | |
|-------------------|-----------|-----------------------|
| MENU SETUP | 20 | System Setup |
| | 26 | Setting the Device |
| | 37 | Setting the Recording |
| | 39 | Setting the Event |
| | 42 | Network Configuration |

20

| | | |
|--------------------------|-----------|----------|
| SEARCH & PLAY | 51 | Search |
| | 52 | Playback |

51

| | | |
|----------------------------|-----------|-----------------------|
| STARTING WEB VIEWER | 54 | What is Web Viewer? |
| | 54 | Connecting Web Viewer |

54

| | | |
|--------------------|-----------|--|
| LIVE VIEWER | 56 | Live Viewer |
| | 58 | Live Screen Configuration |
| | 62 | Controlling a Connected Network Camera |

56

| | | |
|----------------------|-----------|---------------|
| SEARCH VIEWER | 64 | Search Viewer |
|----------------------|-----------|---------------|

64

| | | |
|---------------------|-----------|--------------|
| SETUP VIEWER | 67 | Setup Viewer |
|---------------------|-----------|--------------|

67

| | | |
|----------------------|-----------|-------------------|
| BACKUP VIEWER | 77 | SEC Backup Viewer |
|----------------------|-----------|-------------------|

77

| | | |
|-----------------|-----------|------------------------|
| APPENDIX | 79 | Using Virtual Keyboard |
| | 79 | Troubleshooting |

79



GETTING STARTED

Starting the system

1. Connect the power cable of the NVR to the wall outlet.
2. You will see the initialization screen.
The initialization process will last about 2 minute.
If a new HDD is installed, the initialization process may take longer.



The following symptoms might be observed when starting the system.

-  If the HDD number is displayed at the bottom of the screen along with while the product is booting up, it indicates that the HDD is in recovery, and for this reason booting up may take longer.
-  If the progress stalls while in state, it indicates that the HDD has problems. Visit your nearest customer service center to check the HDD.



3. The live screen appears with a beep.

Install Wizard

As shown below, proceed through each step of the <Install Wizard>.

1. In the <Language> screen, select the language and press the <Next> button.
2. In the <ID/PW> screen, set the password and press <Next>.



Setting up the admin password

When you click , a basic guide for setting a password is displayed. Check the password setting rules.

Setting Camera Password

You can change the password of the camera en bloc if the camera password is in a factory reset state. If the camera password is not in a factory reset state, please enter the password of the current camera to register the camera.

-  You cannot change password of a camera registered using ONVIF or RTSP.

3. In the <Network> screen, set the network access method and the access environment. To use a simple intranet, click <Next>.

Setting up the DHCP server

If you set up the DHCP server, the IP address is automatically assigned to your camera. For more details, see the "DHCP server" page under "Menu Setup > Network Configuration" in the Table of Contents.

-  Depending on the camera's state, no IP may be automatically assigned to the camera. After exiting the installation wizard, go to the menu to assign an IP to DHCP, or set the IP manually.

Setting up the network

Each NVR product supports a different number of network ports. If a product supports two or more, then each network port will provide the following features.

- Camera: Can be used as a port for connecting a camera. If you connect a camera, then the camera video will be transmitted.



- If a UTP cable is used for connection, (UTP) is displayed; if a fiber optic cable, (Optic).

- Viewer: Can be used as a port transmitting video to the web viewer. If you access the network information on your browser, then you can remotely monitor video in your web viewer.
- All: Can be used as a shared port for the camera and web viewer connection.
- Wi-Fi : Port to connect to external Wi-Fi. Wi-Fi port is used for backup.
 - IP type: Allows you to select the type of network access.
 - IP address, subnet mask, gateway, DNS
 - Static: IP address, subnet mask, gateway, and DNS can be directly entered.
 - DHCP: IP address, subnet mask, gateway, and DNS can be automatically set.
 - PPPoE: IP address, subnet mask, gateway, and DNS can be automatically set.
 - User ID, password: To set the access mode to PPPoE, enter the "User ID" and "Password" registered to PPPoE.



- If the LAN cable is not connected to the port, the setting button will not be activated for use. Check the LAN cable connection. (But in case of a PoE product, Network 1 is activated.)
- The built-in DHCP Server in NVR will turn on automatically at stage 3. At this stage, using the existing DHCP server in the same network may cause a problem, as two DHCP servers would be simultaneously operating.
- A product with multiple network ports cannot use a single bandwidth for all of them.

Example)

- Port 1: 192.168.100.199 / Port 2: 192.168.100.198 (X)
- Port 1: 192.168.100.199 / Port 2: 192.168.101.198 (O)

Setting the Switch Mode

Set the camera registration method. This function is only available for products with PoE support. For products with PoE support, see "NVR products supporting each feature". (Page 4)

- PhP Mode : Camera connected to the PoE port of the product will be registered automatically on each channel in the order of the port number. This works only when camera is in factory reset state.
- Manual Setup Mode : Automatically scans and registers camera connected to the product's PoE and camera with separate switch.

4. After setting the date/time settings in the <Date/Time> screen, click on the <Finish> button to launch the setting completion window.

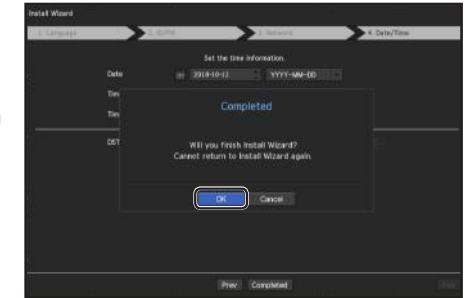

5. In the setting completion window, click on the <OK> button to finish camera setting and launch the camera registration screen.

6. Cameras connected to the PoE port are automatically registered and displayed in the camera registration list. Select the cameras to be registered from the list of cameras, and click the <Register> button.

- The camera may not be shown in the list if there is no response from the camera. You can re-import the list by pressing the < Refresh > button.

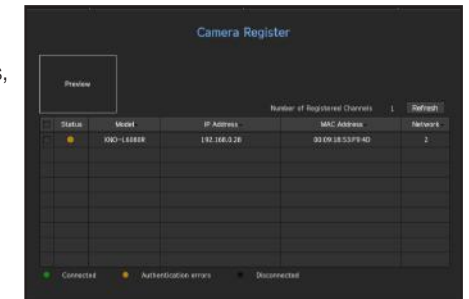

7. When camera registration is finished, the frame rate of the set recording profile is displayed. After you click the <Manual Setup> button, you can modify the frame rate value.



- The recording settings are only applied to initialized cameras.



Shutting Down the System

1. In the live screen menu, select <Shutdown>.
2. The "Shutdown" confirmation pop-up window will appear.
3. Click on <OK>.
The system will shut down.



- Only the user with the "shutdown" permission can shut down the system.
- To manage Permission Setup, see the "User" page under "Menu Setup > System Setup" in the Table of Contents.

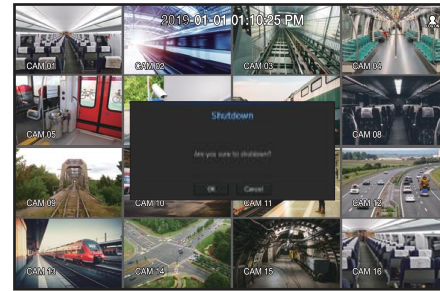

Login

To use the NVR menu, you are required to login as a user that is authorized to access the applicable menu.

1. Right click with your mouse button on the live mode screen.
You will see the context menu on the screen as shown.
2. Select <Login>.
The login dialog appears.



- The initial administrator ID is set to "admin" and you will need to configure the password in the installation wizard.
- Please change your password every three months to safely protect personal information and to prevent the damage of the information theft.
Please, take note that it's a user's responsibility for the security and any other problems caused by mismanaging a password.



- For more information about limited-access permission, see the "User" page under "Menu Setup > System Setup" in the Table of Contents.

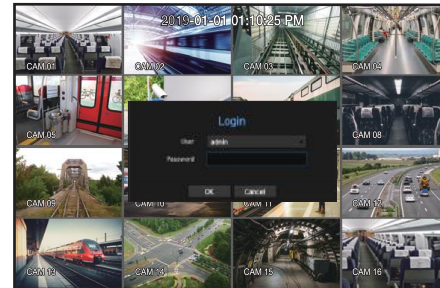







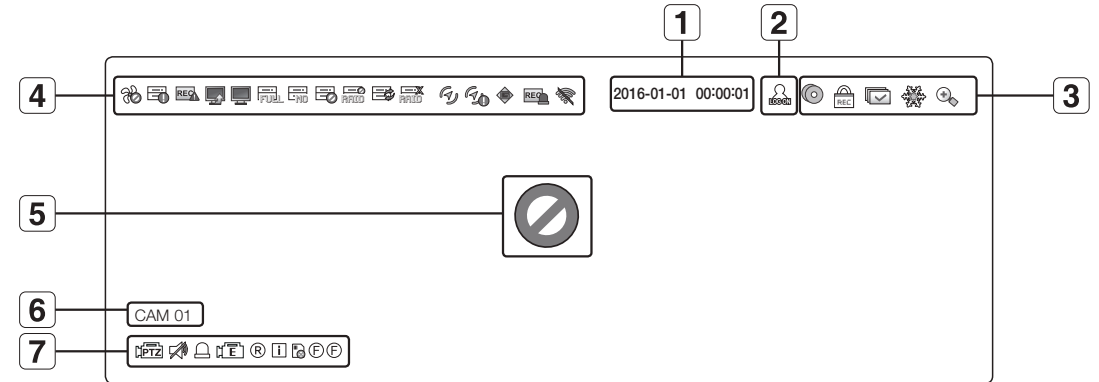





LIVE SCREEN CONFIGURATION





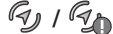

Icons on the Live Screen

You can check the status or operation of the NVR with the icons on the live screen.









| Name | | Description |
|------|--------------------|--|
| 1 | Current Date, Time | Displays the current time and date. |
| 2 | Login Information | When you are logged in, the "LOG ON" icon will be displayed. |
| 3 | Screen Mode | It is displayed when there is ongoing backup in the live condition. |
| | | Displayed when manually recording a video while the access restriction for stop recording is enabled. Only a user with the permission to stop recording is allowed to stop recording. |
| | | It is displayed when all the channels are switched at the set time interval. |
| | | This icon is displayed when you press the Freeze button. |
| | | It is displayed when the magnifying function is in operation. |
| 4 | System Operation | It is displayed when there is a problem with the fan. Only provided for products that support fans. (See page 4 of the Product Specification Manual) |
| | | Displayed when recording data is not properly saved. |
| | | Appears when input data rate per channel exceeds the specified data rate limit. |

| | | Name | Description |
|---|--|---|--|
| 4 | System Operation |  | It is displayed when there is firmware to update the server. |
| | |  | It is displayed when the network is overloaded. <ul style="list-style-type: none"> It occurs when the max receiving allowance is exceeded, causing an overload to the CPU. It will disappear if you modify the camera settings or delete a camera to reduce the performance burden. |
| | |  | Displayed if the HDD is full and the NVR has an insufficient space to record. |
| | |  | Displayed when there is no HDD or HDD is not detected. |
| | |  | Displayed if the HDD needs a technical examination. |
| | |  | It is displayed when there is a malfunctioning HDD in the RAID. <ul style="list-style-type: none"> There are one or two HDD malfunctions but you can still read or write to it. Only provided for products that support RAID. (See page 4 of the Product Specification Manual) |
| | |  | It is displayed when recovering a RAID Error. <ul style="list-style-type: none"> Only provided for products that support RAID. (See page 4 of the Product Specification Manual) |
| | |  | It is displayed when you cannot write RAID due to a malfunction of HDD. <ul style="list-style-type: none"> Only provided for products that support RAID. (See page 4 of the Product Specification Manual) |
| | |  | Shows GPS reception/no reception. |
| | |  | Shows the vehicle shake state. |
| | |  | Appears when emergency recording is in progress. |
| | |  | Displays the Wi-Fi connection status when <Wi-Fi Enable> is set. |
| | | 5 | Video Input Status |
|  | Displayed when the live image with the camera turned <ON> exceeds the supported resolution. | | |
| WISENET | Displayed if no permission to live view is granted. | | |
| | If the camera channel is <OFF>, the camera is not registered, or it is set to <Covert2>, the live screen will display nothing. For <Covert1>, the screen will display nothing but OSD. | | |
| 6 | Camera Title / Channel | Display the camera title and channel number. | |

| | | Name | Description |
|---|------------------|---|--|
| 7 | Camera Operation |  | This icon is displayed for a channel that a PTZ-featuring camera is connected to. |
| | |  | Displays AUDIO ON/MUTE. Not displayed in video mode if deactivated. |
| | |  | If the sensor is set to <ON>, the input signal will be displayed on the screen of the connected channel. |
| | |  | This icon is displayed when Motion Detection is set to <ON> and a camera motion or camera event occurs. |
| | | (R) / (E) / (S) | It displays the status of general/event/scheduled recording. |
| | |  | It is displayed when it fails to decode all the frames due to limited decoding performance and in this case only the I-Frame is decoded. |
| | |  | RED - Displayed when there is any abnormality in the RED-SD card. YELLOW - Displayed when there is no storage space in the SD card. |
| | |  | Flickers when a defocus event occurs. When you click the icon, a simple focus command is sent to the camera. |

Error Information

- If the built-in HDD is not connected, the “NO HDD” icon () will be displayed in the top left corner. In this case, make sure you contact the service center for assistance as this may cause a failure of recording, playback or backup.
 - If you do not format a purchased HDD in a format supporting NVR, a "NO HDD" icon() will be displayed on the top left side of the screen. If the "NO HDD" icon is displayed, go to "**Menu > Storage Device**" to check the HDD connection status, and format your HDD.
 - If a product with a fan does not work or has a problem with the fan, <Fan Information Window> appears and the fan malfunction icon () is displayed at the top left. In this case, check the fan inside the product. If the fan is defective, it can shorten the product life cycle, so please make sure to contract service center nearby.
-  ■ If an abnormal Fan icon () or NO HDD () icon, HDD FAIL () icon is displayed, contact our customer service.
- For products that support fan, see “**NVR products supporting each feature**”. (Page 4)

Live Screen Menu

If you right click with your mouse button in live screen mode, it will launch the live screen menu where you can access each menu.

The context menu differs depending on the state of Log in/out, split mode, and NVR operation status.

-  ■ Depending on the user permissions, you may have limited access to menu items of Live View, Backup, Stop Recording, Search, PTZ, Remote Alarm Output, and Exit.

Single Mode Menu

The single mode menu is available only in Single Mode.

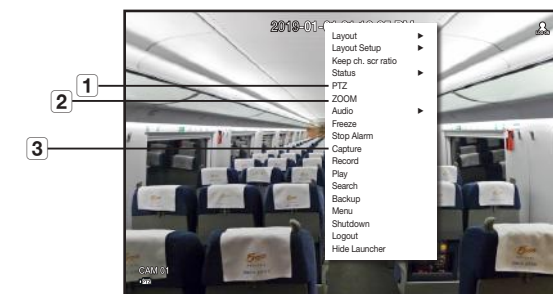

| Menu | Description |
|------------------|---|
| 1 PTZ | Accesses the PTZ Control menu. The PTZ menu will be active on the Live screen after you select a single channel. For more details, see the " Live > PTZ Control " page in the Table of Contents. |
| 2 ZOOM | You can enlarge the selected screen. See the " Live > Zoom " page in the Table of Contents. |
| 3 Capture | Captures the screen of the selected channel. See the " Live > Capture " page in the Table of Contents. |

Split Mode Menu

In Live split mode, right-click to display this context menu as shown. The look of the split mode menu is different for each NVR product and it also depends on the login/logout status.

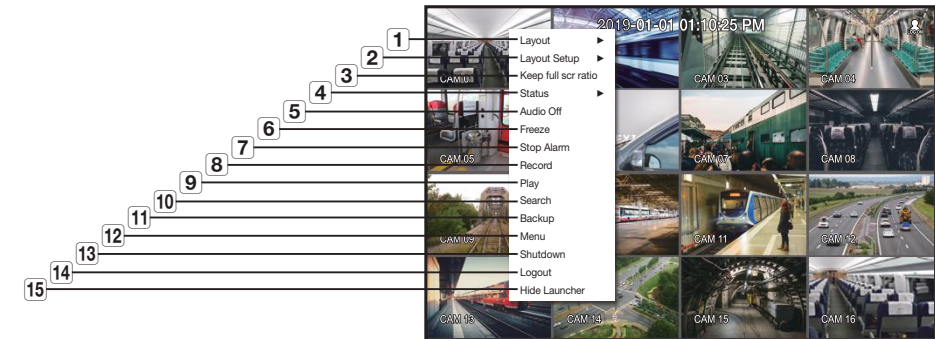

| Menu | Description |
|---|---|
| 1 Layout | Select the split mode to display on the live screen. See the " Live > Live screen mode " page in the Table of Contents. |
| 2 Layout Setup | Set the layout of each channel. See the " Live > Layout " page in the Table of Contents. |
| 3 Keep full scr ratio / Keep ch. scr ratio | Channel screen ratio is changed. See the " Live > Maintain the Screen Ratio " page in the Table of Contents. |
| 4 Status | Shows the connection information of camera connected to each channel as well as live and recording status. See the " Live > Status " page in the Table of Contents. <ul style="list-style-type: none"> ■ For product supporting PoE, you can check the PoE status under “PoE Status”. ■ Only provided for products that support PoE. (See page 4 of the Product Specification Manual) |
| 5 Audio On/Off | Turns ON/MUTE the sound of the selected channel. See the " Live > Audio ON/OFF " page in the Table of Contents. |
| 6 Freeze | Stop playing the video temporarily. See the " Live > Freeze " page in the Table of Contents. |
| 7 Stop Alarm | Stop the alarm output, deactivate the event icon and release the auto sequencing. See the " Live > Event Monitoring " page in the Table of Contents. |
| 8 Record/Stop | Starts or stops manual recording. |
| 9 Play | See the " Search & Play > Play " page in the Table of Contents. |
| 10 Search | See the " Search & Play > Search " page in the Table of Contents. |

| | Menu | Description |
|----|--------------------|--|
| 11 | Backup | Searches for a backup device and back up each channel at your desired time. See the " Live > Backup " page in the Table of Contents. |
| 12 | Menu | Enter the main menu. See the " Menu Setup " page in the Table of Contents. |
| 13 | Shutdown | The system shutdown dialog will appear. |
| 14 | Login/Logout | You can log in or out. |
| 15 | Show/Hide Launcher | Shows or hides the launcher. Refer to " View the Launcher Menu ". |

View the Launcher Menu

The Launcher menu appears on the bottom of the live screen.

1. Select **<Show Launcher>** in the context menu of the Live screen.
2. Move the cursor to the bottom and click a desired item in the Launcher menu.

 If no input is entered for 10 seconds, the menu will disappear.

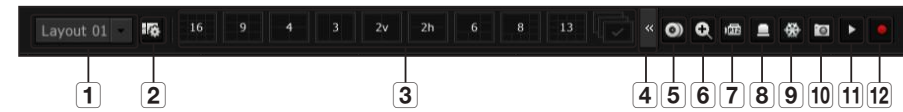

| | Menu | Description |
|----|-----------------------|--|
| 1 | Layout | Select the layout to be displayed on the screen. |
| 2 | Layout Setup | You can set, change or delete the new layout of each channel. |
| 3 | Screen Mode | Displays a list of split modes available in a bar type. The current screen mode will be displayed grey. |
| 4 | Menu Expansion Button | Click to display the hidden menu to the right. |
| 5 | Backup | Searches for a backup device and back up each channel at your desired time. |
| 6 | Zoom | Enlarges the selected area. This is available only in Single Live mode. |
| 7 | PTZ | If the network camera connected to the selected channel supports the PTZ operations, this will run the PTZ control launcher. |
| 8 | Alarm | Stops the alarm if it's activated. |
| 9 | Freeze | Freezes the Live screen temporarily. |
| 10 | Capture | Captures the screen of the selected channel. |
| 11 | Play | Enters Play mode if a file to play exist, and if not, enters Search mode. |
| 12 | Record | Start/End recording the Live screen. |

LIVE SCREEN MODE

You can display your camera's live video in various split modes.

-  The 'Live4NVR' profile is added automatically with camera auto registration, and settings can be changed according to user environment.
 - Live4NVR Profile Basic Settings H.264 (codec), 800 x 600 (resolution), 30fps (frame rate)
- Depending on camera specification, you may not be able to add a profile or if you have the PLUGINFREE profile, you will not be able to add the Live4NVR profile.
- If performance is lowered due to system overload, only the key frame (I-frame) can be played.
- To set profiles, see the "Camera Setting" page under "Menu Setup > Setting the Device".

Method for displaying screen mode

If you want to change the split mode, select a screen mode suggested in the launcher menu or right click with the mouse button and select a split mode in the screen mode menu.

-  Each product may support different split view modes.

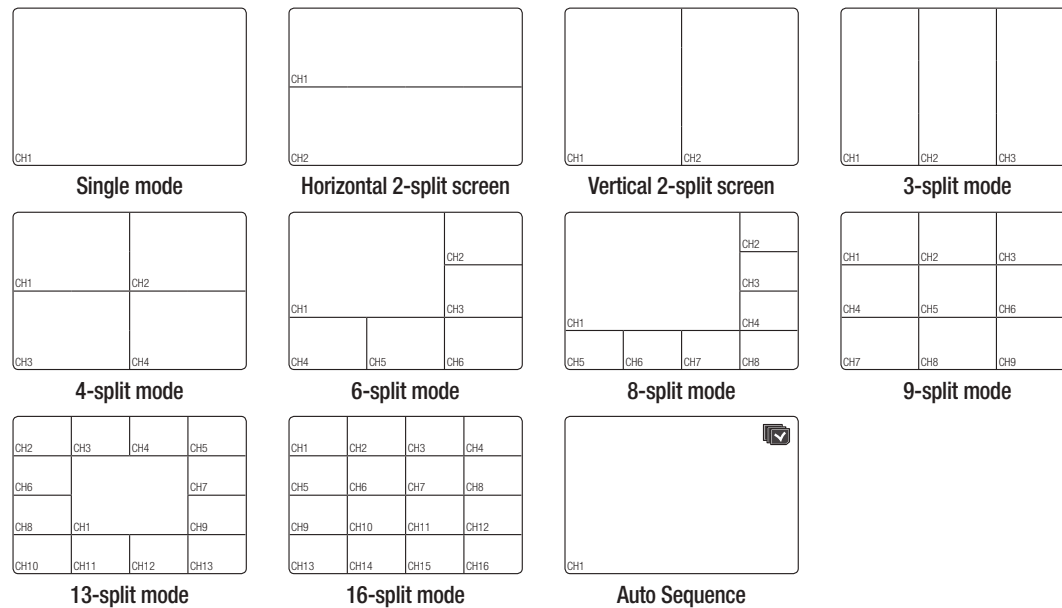

Switching the split mode

You can split the live video from cameras to Single, 4-split, 9-Split, or 16-split mode and watch them one by one.

-  Each product supports different split modes. For more information, see "Method for displaying screen mode".

Press the button in the launcher or use the right menu to automatically switch the screen.

Mouse right button menu → Layout → Auto switching mode

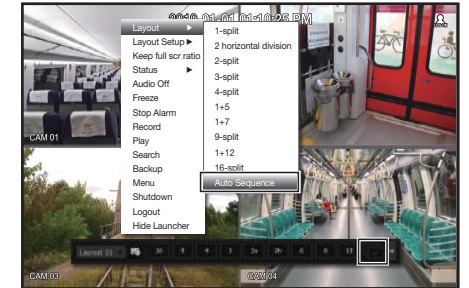

Auto Sequence

You can monitor the split mode of your own choice by switching one after another at a certain interval.

-  For segmented screen switching, set <Sequence switching time> on the "Monitor" page under "Menu Setup > Setting the Device" in the Table of Contents to automatically switch to the next sequence according to the preset time.
 - When you switch the channel, the video may be delayed depending on the network condition.

Example) TRM-1610S

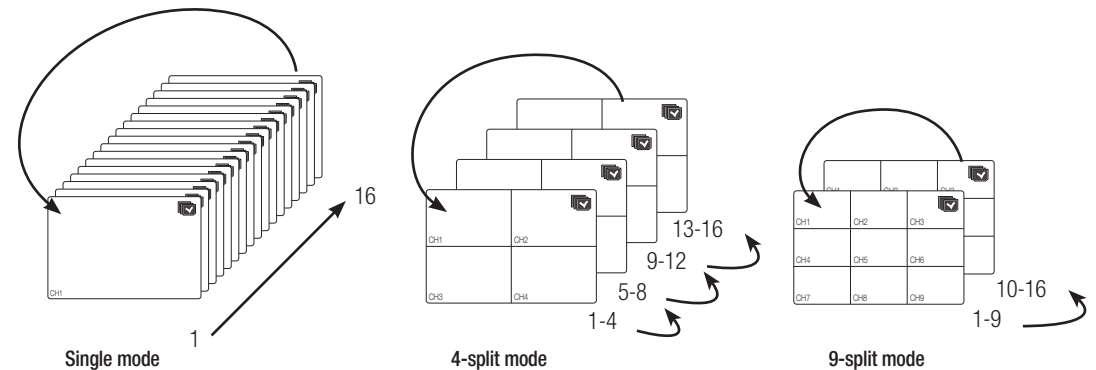

Manual Switching

Click the arrow <◀/▶> key to move to the next split mode.

Example 1) After setting to 9-split mode in TRM-1610S, if you press the Right [▶] button:

Channel (CH 01~9) → Channel (CH 10~16)

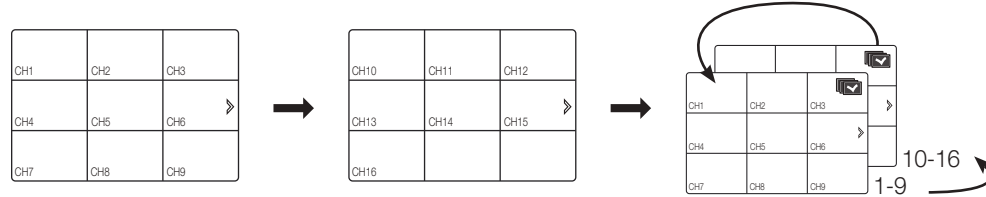

Example 2) After setting to 4-split screen mode in TRM-810S, if you press the right [▶] button:

Channel (CH 1~4) → Channel (CH 5~8)

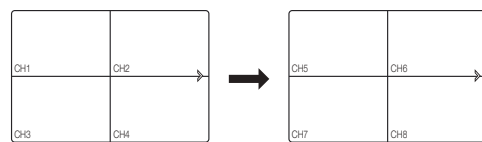

STATUS

You can check the connection information of the camera to be connected to each channel on the live screen.

Channel info

Right-click on the live screen and select <CH Info> in the <Status> menu to display the information on the current video in overlay over the live video being monitored.

- ARB is only displayed when an ARB situation occurs.
- The letters shown next to the product name represents the protocol used to register the camera.
 - S and V represent Wisenet protocol while O represents ONVIF.
 - If connected using the RTSP protocol, then only RTSP is displayed without any product name.



Connection

Right-click on the live screen and select <Connection> in the <Status> menu to check the status of cameras connected to each channel.

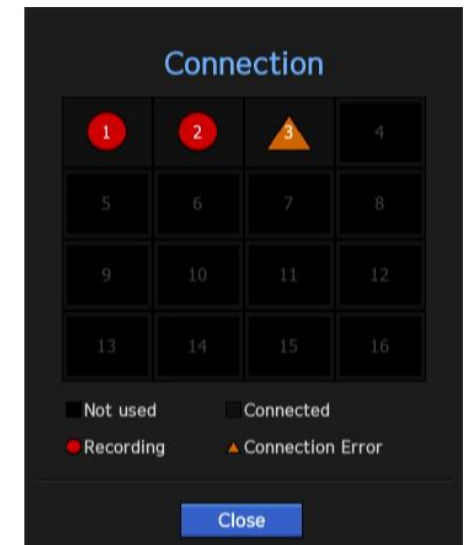

Live Status



Right-click on the live screen and select <Live> in the <Status> menu to check the transmitted data from a camera connected to each channel.

- Model : Displays the model name of camera connected to each channel.
- Status : Shows the connection status of camera set to each channel.
- IP Address : Displays the IP address of a camera set to each channel.
- Codec : Displays the live profile codec information for a camera set to each channel.
- Resolution : Displays the live profile resolution of a camera set to each channel.
- Frame Rate : Displays the live profile transmission rate for a camera set to each channel.

| CH | Model | Status | IP Address | Codec | Resolution | Frame Rate |
|----|-------------|--------------|--------------|-------|------------|------------|
| 1 | XNO-L406SR | Connected | 192.168.0.38 | H.264 | 8000000 | 30FPS |
| 2 | XNO-L406SR | Connected | 192.168.0.38 | H.264 | 8000000 | 30FPS |
| 3 | Wisenet CAM | Disconnected | 192.168.4.38 | - | - | - |
| 4 | - | - | - | - | - | - |
| 5 | - | - | - | - | - | - |
| 6 | - | - | - | - | - | - |
| 7 | - | - | - | - | - | - |
| 8 | - | - | - | - | - | - |

Record Status

Right-click on the live screen and select **<Record>** in the **<Status>** menu to check each channel's profile, record type, input/recording frame count, allowed/input/recorded amount of data.

- Total Bitrate (Record/Max) : Record bitrate shows the amount of actual data recording while Total bitrate shows the maximum data transfer allowed by the NVR.
 - Profile : Shows the video profile configured to each channel.
 - Frame (fps) : Show the input/record frames per second for each channel.
 - Bitrate (bps)
 - Limit / Input / Record : Shows the amount of limit/input/ recording data for each channel.
 - Input / Limit : Shows the data ratio of actual data transferred from the camera and allowed maximum defined by user.
 - Current : Shows the recording status information of currently transferred data.
 - MAX : Shows recording information of the most biggest recording data out of configured standard and event recordings.
 -  : Reloads the recording information.
 - Record Setup : The menu screen will switch to the record setting screen.
-  ■ If an error occurs during recording, the channel's profile column turns yellow. This profile error indicates that when a recording profile cannot be used to receive video from camera, an alternative profile is used to record the video. When the recording profile resumes, the camera video can record by using the set recording profile.
- If NVR exceeds the recording limit, only the key frame will be recorded. In that case, a restricted recording popup and an icon will appear. The restricted recording popup appears only once. If you change the camera setup and record setup, the restricted recording popup may appear once more to confirm the status. If you don't want to see it again, then check Do not show this again in the popup.
- For the maximum allowed number of recording, see the **"Record Setup"** page under **"Menu Setup > Setting the Recording"** in the Table of Contents.

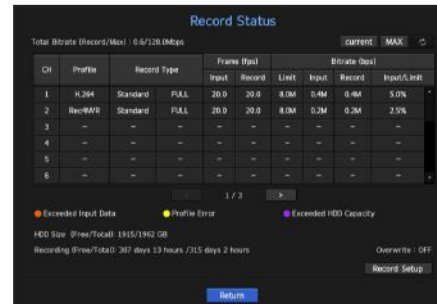

| CH | Profile | Record Type | Frame (fps) | | Bitrate (bps) | | | | |
|----|---------|-------------|-------------|--------|---------------|-------|--------|-------------|------|
| | | | Input | Record | Limit | Input | Record | Input/Limit | |
| 1 | H.264 | Standard | FULL | 20.0 | 20.0 | 8.0M | 5.4M | 0.6M | 5.0% |
| 2 | Rec-WDR | Standard | FULL | 20.0 | 20.0 | 8.0M | 5.2M | 0.2M | 2.5% |
| 3 | - | - | - | - | - | - | - | - | - |
| 4 | - | - | - | - | - | - | - | - | - |
| 5 | - | - | - | - | - | - | - | - | - |
| 6 | - | - | - | - | - | - | - | - | - |

● Exceeded Input Data
 ● Profile Error
 ● Exceeded HDD Capacity
 HDD Size (Free/Total): 1935/1962 GB
 Recording (Time/Total): 207 days 13 hours / 315 days 2 hours
 Overwrite: OFF
 Record Setup

PoE Status

This function is only available for products that support PoE. For products with PoE support, see **"NVR products supporting each feature"**. (Page 4)

Right-click on the live screen and select **<PoE>** in the **<Status>** menu to check the current PoE status of each port.

1. Select the **<PoE Status>**.
PoE status view window is displayed.
- Consumption(W) : Displays the power consumption in PoE.
 - 0 : No device is connected to the port or a device is using its own power supply.
 - - : Trouble in the port (More detailed trouble information can be displayed in additional information.)

-  ■ For more information on the whole full PoE power specs of each product, see **"Product Specification Manual"**. If the power limits of all ports exceed the PoE specification, each port will be powered down one by one.

- PoE : Turns on/off the power supply to the camera.
If checked, it means the power supply is On; if not checked, it means it is Off.
- Additional information : If there is a problem in the power supply, it is explained here. Power supply problems include excessive power (class 1 to 4) and voltage errors.
- Total PoE power consumption : Display the sum of power consumption for all the ports.

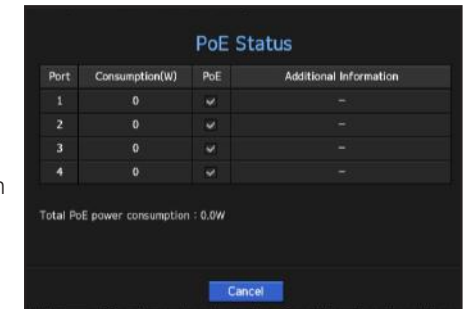

| Port | Consumption(W) | PoE | Additional Information |
|------|----------------|-------------------------------------|------------------------|
| 1 | 0 | <input checked="" type="checkbox"/> | - |
| 2 | 0 | <input checked="" type="checkbox"/> | - |
| 3 | 0 | <input checked="" type="checkbox"/> | - |
| 4 | 0 | <input checked="" type="checkbox"/> | - |

Total PoE power consumption : 0.0W

Cancel

Channel Setting

You can display the channel in a desired area of a split screen.

1. Place the cursor over the camera name of each channel to display the <▼> key to the right on the screen.
2. Click a camera name to display a channel list where you can select a different channel.
3. Select a desired channel and click it.
The current channel will be switched to the selected one.

 Use the cursor to select a channel to move, and drag and drop it to a desired channel; this can also change the channel position.

Example) If switching CH 1 to CH 7



Switching to Single Mode

When in split mode, select and double-click a desired channel to switch to its Single mode.

Example) If double-clicking CH 3.

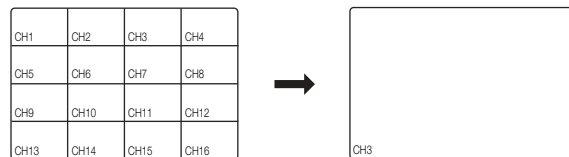

ZOOM

This is activated only in Live Single mode.

1. After right-clicking on the live screen, click <ZOOM>.
You can also press the [ZOOM] button on your remote controller or click <🔍> in the launcher menu. The Zoom in icon will appear at the bottom right.
2. Click <⊕> icons to magnify the selected area.
By adjusting the box at the bottom, you can adjust the position of the magnified screen.
3. Click <⊖> icons to zoom out the selected area.
4. Click <✕> at the top right to close zoom.



LAYOUT

In the live screen, you can set the layout for each channel.

Setting Up the Live Layout

This section outlines how to select a series of channels based on their purpose/accessibility and monitor them in a single layout.

Example) Layout "Indoor" - Guest Room Camera 1, Guest Room Camera 2, Guest Room Camera 3
Layout "VIP" - VIP Room Camera 1, VIP Room Camera 2, VIP Room Camera 3, Corridor Camera

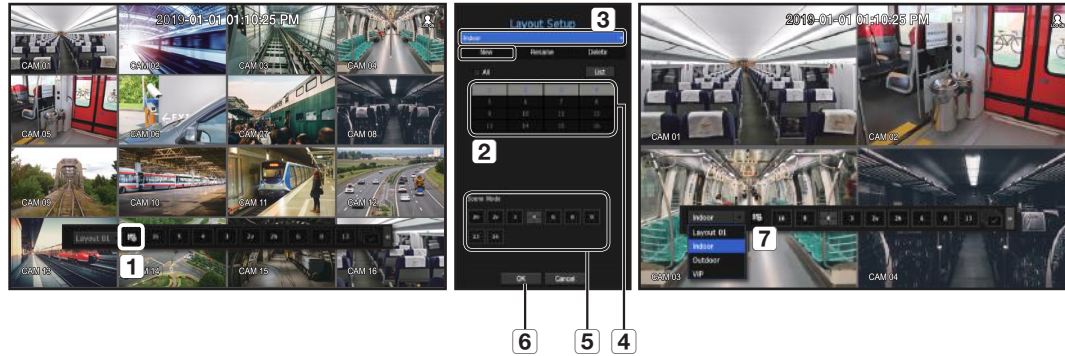

To create a new layout, follow these steps:

1. Open the channel layout setup menu.
 2. Click **<New>**.
 3. Enter a name for the selected channels (e.g., Indoor).
 4. Select the channels that you want to add to the layout (e.g., 1, 2, 3, 4).
 5. Choose a split mode to apply (e.g., 4-way split).
 6. Click **<OK>**.
 7. Choose a layout to view it on the screen (e.g., change to Indoor).
1. Select the **<New>**.
The layout setting screen will appear.
 - New : You can set the new layout.
 - Rename : You can make changes to the selected layout.
When the layout is changed, the channel order is initialized.
 - Delete : You can delete the selected layout.
 - Channel Table : You can select channels in the table to be registered in, or removed from the layout.
 - Channel List : You can select channels in the list to be registered in, or removed from the layout.
 2. Press the **<New>** button and enter the name of layout to add.
 3. In the **<Ch. Table>** or **<Channel List>**, click and select the channel to be displayed on the layout screen.
 4. Click on **<OK>** to save the selected layout.

- 
 - The layout for each user is saved separately.
 - You can use a configured layout even in the Search Time function to facilitate search using the channel sequence and combination that you have set.
See the **"Time Search"** page under **"Search & Play > Search"** in the Table of Contents.

AUDIO ON/OFF

You can turn the sound on/off corresponding to the channel in Live mode.

AUDIO ON/OFF in Single mode

Click on the audio icon (🔊) on the screen to turn it ON/OFF.

- 
 - If you have configured the audio output settings properly but the audio or voice is not output, check if the connected network camera supports the sound signal and if you have configured the sound settings as appropriate.
The sound icon can be displayed if the sound signal fails to output from noise.
 - Only the channel where **<AUDIO>** is set to **<ON>** in **"Setting the Device > Camera"** displays the audio icon (🔊) in Live mode that you can use to turn the sound on/off.

FREEZE

This is available only in Live mode, this pauses playing the Live image temporarily.

1. Click **<Freeze>** of the launcher mode.
Video playing is paused.
2. Click on **<Resume>**.
Pause is canceled. Playing is resumed.

EVENT MONITORING

This will display the channel in sync with a specific event (Sensor/Motion/Video Loss) if it occurs. To use the event monitoring function, you should set the <Event Display> by referring to the "Monitor" page in the table of contents "Menu Setup > Setting the Device".

- If multiple events occur simultaneously, the screen will switch to a split mode.
 - 2 ~ 4 events : 4-split mode
 - 5 ~ 9 events : 9-split mode
 - 10 ~ 16 events : 16-split mode
- If the second event occurs within the set time of <Event Display>, the first event will last until the second one is terminated.

Example1)

- If you set <Event Display> to 5 seconds, and only one event occurs in CH 1.

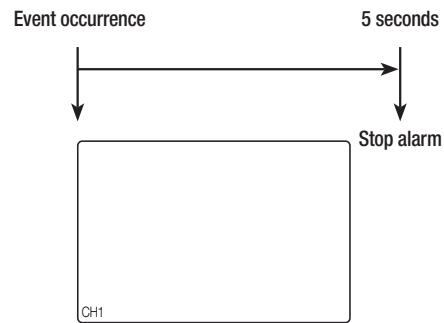

Example2)

- If you set <Event Display> to 5 seconds, and the second event occurs in CH 2 within the set time after the first event occurred in CH 1.

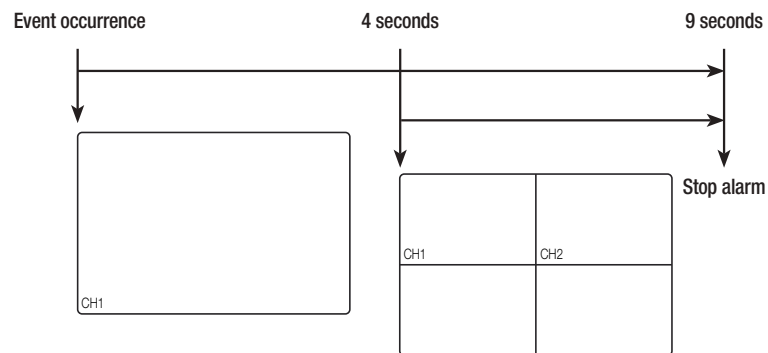

- Select <Stop Alarm> to initialize the status of alarm output and release the event function.
- If an alarm is output with the pre-event and post-event times specified together with the event recording settings, the event recording will perform according to the specified recording type (pre event or post event).



- In case of continuous events such as motion detection, switching to another split mode display may not immediate if concatenating events follow, even when you stopped alarm of the event.
- The video may be delayed depending on the network condition.
- The event output can be delayed as the transfer of the alarm event from the network camera takes time.

CAPTURE

You can capture a screen selected on the live screen. Function to perform in single channel mode on the live screen or when selecting a channel.

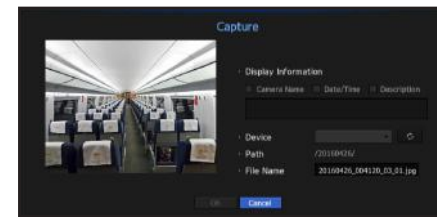

1. Right-click on the live screen and select <Capture>. You can click on <📷> in the launcher menu.
2. Select the output information to be displayed on the captured screen.
 - If the <Description> box is checked, the description field will be enabled where you can enter up to 50 Korean letters.
3. Select a device to save a captured file, file path and file name.
4. Complete the settings and click <OK>, then the image captured from the screen is saved to the selected device.

MAINTAIN THE SCREEN RATIO

The screen ratio for a live video can be changed.

Maintain a screen ratio for all channels

Video screen ratio for all channels can be changed in live split screen mode.

1. Right-click on the live screen and select **<Keep full scr ratio>**.
The screen ratio for all channels will be changed.
2. If you want to go back to the previous screen ratio, check the menu option for **<Keep full scr ratio>**.

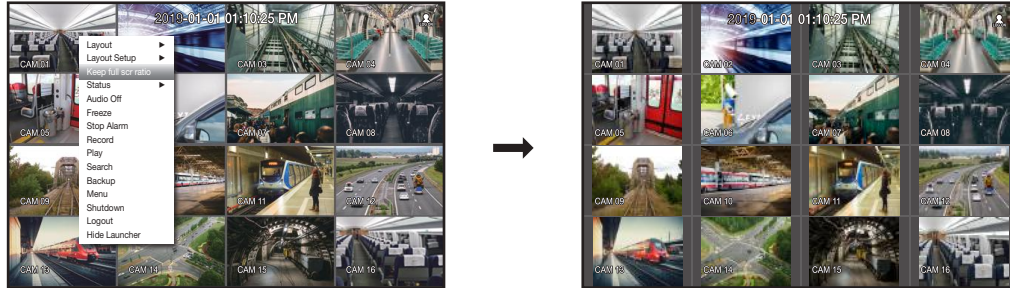

Maintain a channel screen ratio

If you select a channel from a live single screen or split screen, you can change its video screen ratio.

1. Right-click on the live screen and select **<Keep ch. scr ratio>**.
The screen ratio of a specified channel will be changed.
2. If you want to go back to a previous screen ratio, select **<Keep ch. scr ratio>** again.

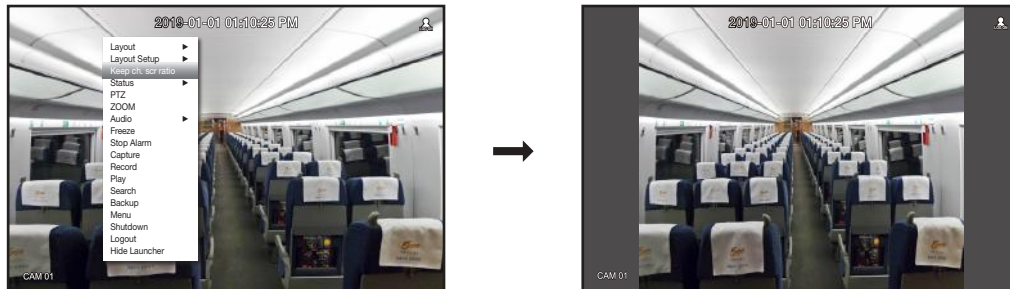

PTZ CONTROL

With this NVR, you can configure the settings of a PTZ camera as well as commercial cameras in the market to your preference.

PTZ device

This is active only if a channel that a PTZ camera is connected to is selected.

Getting started with PTZ operations

The PTZ camera will be activated only if the channel of the PTZ camera is selected, which can be performed in the following way:

- Using the launcher menu : Click **<PTZ>** from the launcher menu of the Live screen.
 - Using the Live screen menu : Select **<PTZ Control>** in the context menu of the Live screen.
 - Using the icons on the Live screen : Simply click the **<PTZ>** icon on the Live screen.
-  This is available only if a PTZ camera is connected and the **<PTZ>** icon is displayed on the screen.
- Even if the connected network camera does not support the PTZ operations, you can configure the PTZ control settings (if possible) by installing the PTZ driver (physical device).
 - It only supports a network camera with Hanwha Techwin's PTZ function and a camera registered in the ONVIF.

Using the PTZ camera

You can use a single PTZ camera to perform the Pan, Tilt and Zoom operations to monitor multiple places, and configure the custom settings of the presets in a desired mode.



1. Open the <PTZ Control> menu.

The <PTZ> icon in the left bottom of the screen will turn yellow, indicating that the system accesses "PTZ Control" mode. You will see the "PTZ Control" launcher menu.



▪ The PTZ working (active) mark can be active even if the PTZ operation is not available in normal mode. So ensure that you have completed the PTZ settings before proceeding.

2. Use the PTZ Wheel in the launch menu to adjust the location of recording by a camera.

- Sensitivity : Adjust sensitivity for Pan, Tilt controls.
- PTZ Wheel : Click a near area from the center to move the camera lens slowly; clicking a far area will move it fast.
 - If clicking and holding the mouse in the left will turn the camera counterclockwise; if clicking and holding the mouse in the right will move the camera lens clockwise.
- Zoom : Activate the Zoom operation of the PTZ camera.
- Iris : Adjust the amount of light incoming to the camera.
- Focus : You can adjust the focus manually.
- Swing : Swing is a monitoring function that moves between two preset points and enables you to trace the motion.
- Group : The group function enables you to group various presets before calling them in sequence.
- Trace : Tracking remembers the trace of movements that you instructed and reproduces it for your reference.
- Tour : Monitor all the groups created by a user in turn.
 - Some cameras may differ in the menu title and operation with regard to Swing, Group, Tour and Trace.



▪ Even if your network camera supports the function, you can use it only if the button is activated in the PTZ control launcher.

Using Digital PTZ (D-PTZ) function

1. Register a camera that supports the D-PTZ profile.
 - In cameras that support the D-PTZ profile, you can use the D-PTZ function.
2. Both cameras that support general PTZ and cameras that support D-PTZ can control the live image using some of the <PTZ control> function menus.
 - For more information about the supported functions, please refer to the camera manual.

Preset

Preset is a set of saved data specifying the locations of a PTZ camera. A single PTZ camera can save up to 300 locations.



To add a preset

1. Check the preset checkbox.
 2. Select <[Keyboard Icon]>.
 - The virtual keyboard will appear on the screen. Use it to provide the preset name.
 - See "Using virtual keyboard" in the Appendix.
 - [Pencil Icon] : You can change the preset settings to your preference.
 - [Trash Icon] : Delete a selected preset.
 - [All Trash Icon] : Delete all the existing preset settings.
-  ▪ If you replace a camera that saves your preset settings with a different one, you must configure the preset settings again.
3. Select <OK>.
 - The preset setting will be saved in the provided name.

To change or delete a registered preset

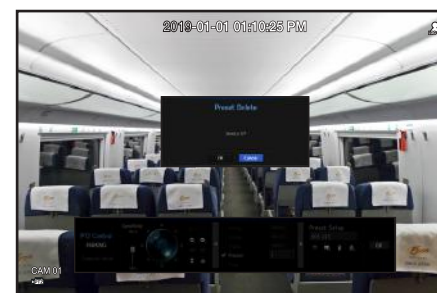

1. Check the preset checkbox and select a preset to change or delete.
 2. Press <[Pencil Icon]> or <[Trash Icon]> as needed.
 - [All Trash Icon] : Delete all the existing preset settings.
-  ▪ Deleting all presets might delete even the default preset from the network camera.
3. Provide a new name and press <OK>.

BACKUP

You can search for a backup device and back up video recording at your desired time for each layout or channel.

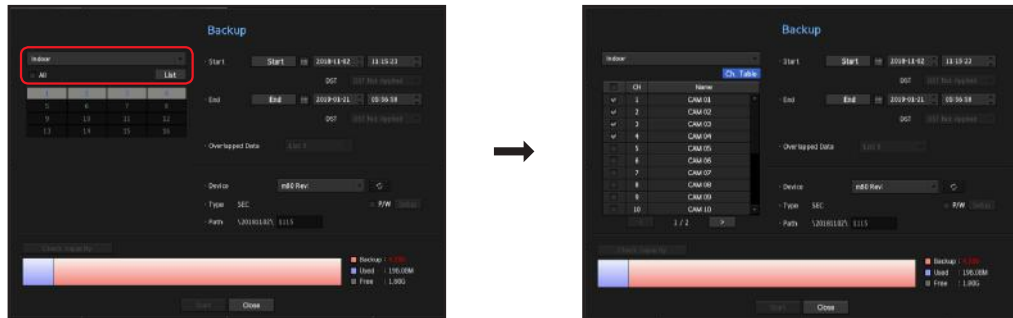

1. Right-click on the live screen and select **<Backup>**.
You can click on **<📷>** in the launcher menu.
2. The backup settings screen will be opened.
 - Select a layout. : Select a desired layout from the layout list.
 - Channel : Sets the channel to backup.
 - You can select multiple channels.
 - If you select **<All>**, all channels will be selected.
 - Backup Range : Sets the **<Start>** and **<End>** time for the backup.
 - Start time : Set the backup start time to your desired time.
If you click the **[Start]** button, the Backup start time is set to the starting time of the last video recording. However, the Start time will not be displayed on the screen. If you click the **[Start]** button once more, the Backup start time is set to the time set by user.
 - End : You can set the Backup end time to your desired time.
If you click the **[End]** button, the Backup end time is set to the ending time of the last video recording. However, the End time will not be displayed on the screen. If you click the **[End]** button once more, the Backup end time is set to the time set by user.
 - Overlapped Data : Shows a list of overlapping data on a same time according to the number of data.
This is displayed when there are duplicate data in the same channel due to changes in the time or time zone.
 - See the "**Setting the Date/Time/Language**" page under "**Menu Setup > System Setup**" in the Table of Contents.
 - Device : Select a backup device from the recognized devices.
 - Type : SEC is a proprietary file format, which can be played on the PC immediately as it is backed up with a dedicated viewer.
 - You can select whether or not to use "**Password Setup**".
 - Path : displays the location of the folder in which the backup file is to be saved.
 - Check capacity : Shows the size of the selected backup data, used and available capacity of the selected backup device.

3. When the backup setup is done, press **<Start>**.

- If there is no device to back up, the **<Start>** button is disabled.



- If you insert a USB memory stick with insufficient storage space, volume calculation may be disabled.
Format the memory stick or delete some of the data on the memory stick to secure adequate storage space.

- The application may slow down during the backup.

- You can switch to the menu screen during the backup in operation, but playback of data is not available.

- The data can be played back on a Webviewer while the backup is in progress but audio does not function.

- If backup has failed, select "**Device > Storage Device**" and check the free space of the HDD and check also if the HDD is properly connected.



- Pressing the **<Hide>** during the backup will return to the previous menu, while the backup progresses.

menu setup

You can setup the system, devices, and options for recording, event and network.

SYSTEM SETUP

You can setup Date/Time/Language, User, System Properties and Log.

Date/Time/Language

Setting the Date/Time/Language

You can check and setup the current Date/Time and time related properties, as well as the language used for the interface on the screen.

Menu > System > Date/Time/Language

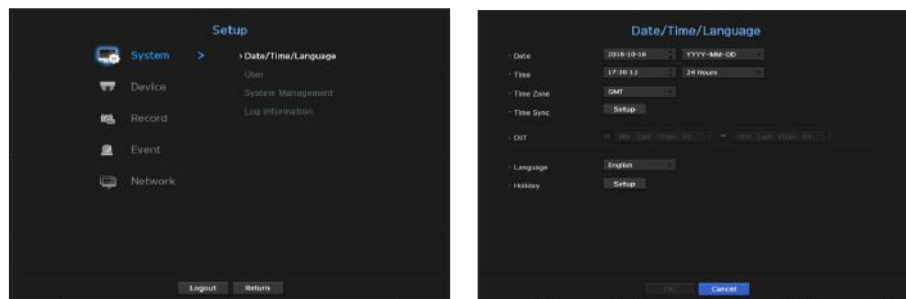

- Date : Sets the date and its format that will appear on the screen.
- Time : Sets the time and its format that will appear on the screen.
- Time Zone : Sets the time zone of your area based on the Greenwich Mean Time (GMT).
 - GMT (Greenwich Mean Time) is standard World Time and the basis of world time zone.
- Time Sync. : Specify the use of synchronization with the time server.
Click the <Setup> button to display time synchronization setup screen.
If <Time Server> is used, the product system time will be synchronized with the time server.
Time information cannot be modified while the time server is being used.
 - Synchronization : Select between GPS and NTP servers.
 - GPS Time Sync : Synchronizes system time by using GPS signal.
 - NTP Time Sync : Synchronizes system time through NTP Server.
 - Time Server : Enter an IP or URL address of the NTP Server.
 - Last Sync Time : Displays the most recent synchronization time with GPS or NTP Server.
 - Activate as Server : use the product as time server of a different network device.
- DST : Set up Daylight Saving Time with its period to make the time earlier than the GMT of its time zone by 1 hour during the set period.
- Language : Select your language. Sets the language for the interface.
English, French, German, Spanish, Italian, Chinese, Russian, Korean, Polish, Japanese, Dutch, Portuguese, Turkish, Czech, Danish, Swedish, Thai, Romanian, Serbian, Croatian, Hungarian, Greek, Finnish, and Norwegian are supported.

 ▪ Depending on the location of the product release, the language and standard time setup may vary.

- Holiday : A user can select specific dates as holidays according to their own preferences. Holidays are applied in the <Recording Schedule> or <Alarm Schedule> setting too.

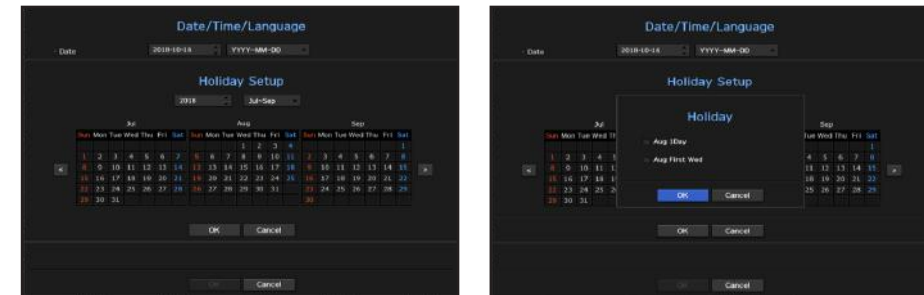

Example) After selecting Aug. 1, if you check <Aug 1Day> only, then Aug. 1 of every year is set to holiday. If you check both <Aug 1Day> and <Aug First Wed>, Aug. 1 and First Wednesday of August every year are set to holidays.

To use the calendar



1. Select year and month.
Select the <◀ ▶> key on both ends of year and month to move back/forward to the previous/next year or previous/next three month.
2. Select a date and click on the <OK> button.
 - A date is marked in gray if there exist data for search for system log, event log, time search and event search.

User

You can set permissions of each user over the NVR's specific function and settings.

Setting the Administrator

You can set and change Administrator's ID and password.
The administrator can use and set all menu items and functions.

Menu > System > User > Administrator

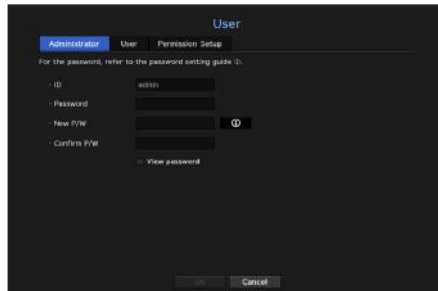

- ID : Change the admin ID.
- Password : Checks the current password.
- New P/W : Enter new password.
- Confirm P/W : Confirms the new password.
 - If <View password> is selected, the password will no longer be hidden on the screen when you type it.

- The initial administrator ID is set to "admin" and you will need to configure the password in the installation wizard.
- Please change your password every three months to safely protect personal information and to prevent the damage of the information theft.
Please, take note that it's a user's responsibility for the security and any other problems caused by mismanaging a password.
- If you click < [View password] >, a basic guide for password setup is displayed.
- See "Using virtual keyboards" in the Appendix.

User setting

You can create a group or set permissions for each group.
You can add a user and edit the registered user information.

Menu > System > User > User

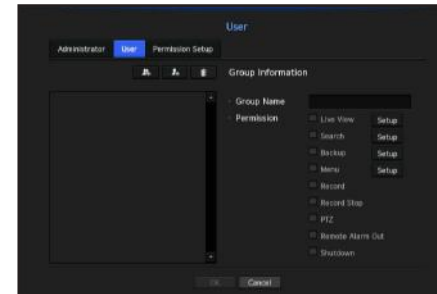

If you want to add a group

1. Click on the [Add] button to launch the Group Addition popup window.
If you want to add a group, click on <OK>.
2. Press the group name item to launch the virtual keyboard used to enter group names.
Enter the group name to register.
 - You can add a maximum of 10 groups.

If you want to set group permission

Set permission to access each group.
Each group's users can only access items with a check mark beside them.

1. Select the menu to set group permissions.
The menu with access permissions will appear when a user of the group logs in.
 - Live View : You can set permissions to access the live screen for each channel.
 - Search : You can set permissions to access the search menu for each channel.
 - Backup : You can set permissions to access the backup menu for each channel.
 - Menu : You can select and set the setting menu that can be accessed. A group user can only access the menu selected. If you select the menu, the menu permission setting screen will be displayed.
 - Record, Record Stop, PTZ, Remote Alarm Out, Shutdown : You can select these functions to add to a group's permissions.
2. Click <OK>.
Check a group user to give them the permission to access the selected item.

If you want to register a user

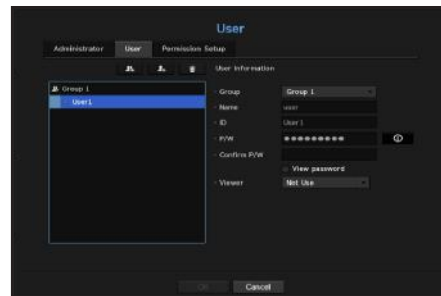

1. Click on the [] button to launch the user addition popup window. To add a user, click on <OK>.
2. Select a group.
When registering a user, the selected group will be automatically registered.
 - A group can be changed after inputting all required information.
3. Enter a name, ID and password (confirm password) and enable or disable the viewer option. If you activate use of <Viewer>, you will have the right to use the web viewer and the network viewer.
 - If <View password> is selected, the password is no longer hidden on the screen when you type it.
4. Click <OK>.
Registered user information will be saved.

When you want to delete the group and user information

1. To delete, click on the [] button.
2. The deletion confirmation window will appear and you can select an item to delete and click on <Delete>.

Setting Permissions

You can set restricted access for all general users. Items with restrictions will require logging in for use.

Menu > System > User > Permission Setup

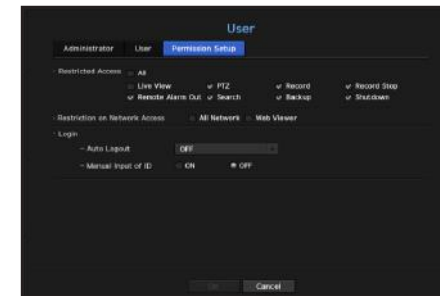

- Restricted Access : All menu items allowed for a user can be set with restricted access.
 - Checked () : Restricted
 - Not checked () : Accessible
 - If it is not checked () in <Restricted Access>, any user can access the item no matter what the <Permission> setting.
 - If it is checked () in <Restricted Access>, a user can access the item only if the user has permission in <Permission> setting.
- Restriction on Network Access : Restricts remote access from a <Restricted Access> network.
 - All Network : Restricts all access instances via Network Viewer and Web Viewer.
 - Web Viewer : Restricts access via the Web Viewer.
- Auto Log out : A user will be automatically logged out if there is no operation on NVR for over set period of time.
- Manual Input of ID : In the login window, select whether to enter ID.

If the user has restricted access

If a new group is restricted to access the entire menus, the users belonging to the group can access only the basic menus and can change only their respective password.

If all permissions are restricted, you will see only some menu items accessible in the Live screen menu.

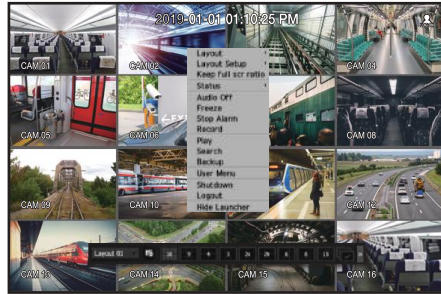

To change the user password

If you log in with the user account of a group with restricted access, you just can change your own password.

Menu > System > User

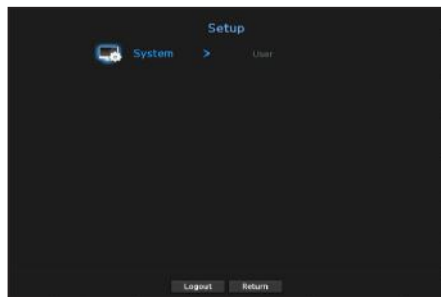

1. Provide the login information.
2. Select <User Menu>. The Permission Management screen appears.
3. Select <User>. The Password dialog shall appear.
4. Provide a new password.
5. Select <OK>. The old password will be changed to a new one.

System Management

You can check the system version, update to a newer version, as well as data backup and initialization.

Checking the System Information

You can check the current software version and MAC address before proceeding with the upgrade.

Menu > System > System Management > System Information

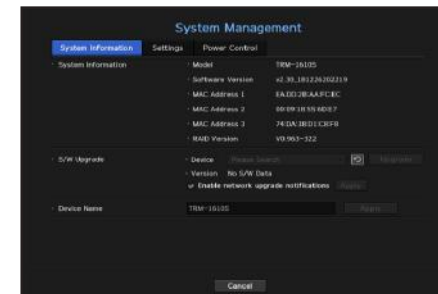

- System Information : Shows the current system's information.
 - Model Name : Shows the model name of the product.
 - Software version: The software version of the product currently being used is displayed. You can check the software version and upgrade to the latest version.
 - RAID version: If the product supports , then the RAID version is displayed.
For products that support RAID, see "**NVR products supporting each feature**". (Page 4)
- S/W Upgrade : Updates th e NVR's software up to date.
 - Press the <🔍> buttons to search for the software in the USB or on the network.
- Device Name : You can enter a device name for your product. To differentiate multiple storage devices in VMS, IP Installer, etc., it is recommended to enter a different device name for each device.

To upgrade the current software version

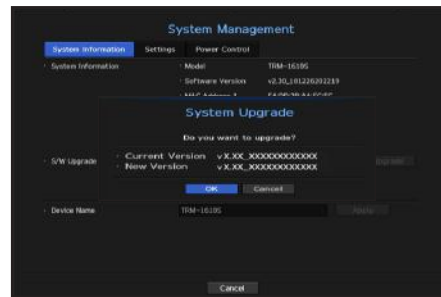

1. Connect a device storing the software to be updated.
 - It may take about 10 seconds to recognize the device.
 - Upgradeable devices include USB memory, and network device.
 - If you want to upgrade it on the network, the product should be connected to an external network. Upgrade via the proxy server may not be enabled due to the restricted access.
2. Select <System Management> from <System> window.
3. Select <System Information>.
4. When the recognized device appears, select <Upgrade>.
 - If you connect a device in the upgrade menu window, you can press the <Search> button to search for available software.
 - If there is an upgrade image on the network, the popup window will appear.
 - The <Upgrade> button is activated only if the software version is the same or higher than the product software version.
5. Press <OK> in the "S/W Upgrade" window.
 - While updating, it shows the progress.
6. When the updating is done, it automatically restarts. Do not turn the power off until it finishes restarting.
 - If "Upgrade Failed" appears, retry from the step 4. When you experience continued failure, consult the service center for assistance.

Settings

You can copy and import the NVR settings by using a storage media.

Menu > System > System Management > Settings

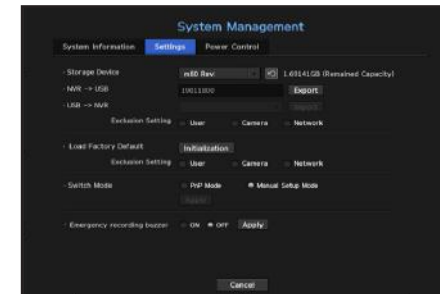

- Storage Device : Shows the connected storage device.
 - Press the <Search> button to view the list of storage devices.
- NVR → USB : Exports NVR settings to the connected storage device.
- USB → NVR : Imports NVR settings from the storage device and applies to the NVR.
 - If you select the exclusion setting, you can import all information but the selected information.
 - The <Export> and <Import> settings can be used in the same software version only.
- Load Factory Default : Resets the product to its factory default settings. However, logs won't be reset. Anything selected under Exclusion Setting won't be part of the factory reset. A confirmation pop-up will appear when you press the <Initialization> button. Select the <OK> button to reset the selected items.
- Switch Mode : Set the camera registration method. This function is only available for products with PoE support. For products with PoE support, see "NVR products supporting each feature". (Page 4)
 - PnP Mode : Camera connected to the PoE port of the product will be registered automatically on each channel in the order of the port number. This works only when camera is in factory reset state.
 - Manual Setup Mode : You can manually register the camera connected to the PoE port of your product and the camera connected to the separate switch in the <Cam Registration> menu.
 - For more information on camera registration, see the "Setting the Device > Camera > To register a camera" section in the table of contents.
- Emergency recording buzzer : You can set whether or not to generate a warning sound when the <EMERGENCY RECORD> button in the control box is pressed.
 - If you export setup information, then the data will be saved as a file in the recorder folder of your storage device.
 - If you want to import setup information, you have to first make sure that the setup information file is located in the recorder folder of the storage device.

How to control power

NVR power-related settings are applied.

Menu > System > System Management > Power Control

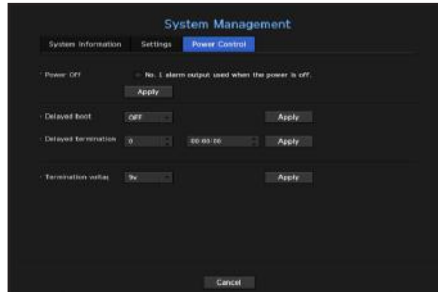

- Power off : If the power is off, the first alarm is generated. After checking the checkbox, if the <Apply> button is pressed, all event alarms that are set to the first alarm output are released, and then the first alarm cannot be selected by other alarm output.
 - If that function is set, the first alarm-out checkbox and all alarms in the alarm setup screen are deactivated, to Off.
- Delayed boot : Sets boot to occur after a certain period of time rather than immediately booting the NVR after power is applied.
- Delayed termination : You can set the time so that NVR is not terminated during backup after the vehicle has stopped.
- Termination voltage : NVR is terminated when the battery voltage of the vehicle drops below the set voltage. The voltage value can be set between 9v and 33v.

! This function will work once 3 minutes has passed after booting. If you set it incorrectly, change the setting value within 3 minutes.

Log Information

You can browse logs on the system and events.

Checking the system log

System Log shows log and timestamp on every system start up, system shutdown, and changes on system settings.

Menu > System > Log Information > System Log

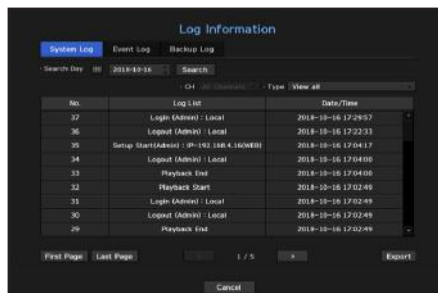

- Search Day : Click the Calendar icon to display the calendar window, or use the direction buttons to specify the search period of the system log.
 - See the "To use the calendar" page under "Menu Setup > System Setup" in the Table of Contents.
- Search : Specify the date and press this button to display the search result in the log list.
- Type : When there are too many logs, you can display logs of the desired format by selecting the type.
- Export : Save all the logged information recorded in the NVR into the storage media.

Checking the event log

You can search recorded events including alarms, camera events and video loss. It also shows the log and its timestamp.

Menu > System > Log Information > Event Log

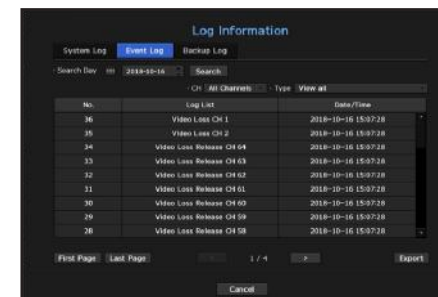

- Search Day : Click the Calendar icon to display the calendar window, or use the direction buttons to specify the search period of the system log.
 - See the "To use the calendar" page under "Menu Setup > System Setup" in the Table of Contents.
- Search : Specify the date and press this button to display the search result in the log list.
- Type : When there are too many logs, you can display logs of the desired format by selecting the type.
- Export : Save all the logged information recorded in the NVR into the storage media.

Checking the backup log

You can find out who backed up and the details (backup time, channel, device to use, file format, etc.).

Menu > System > Log Information > Backup Log

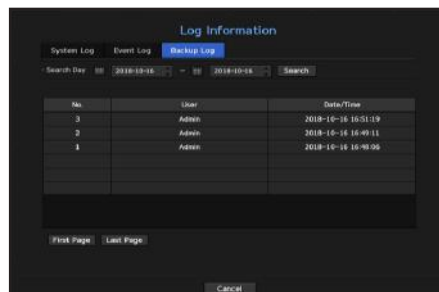

- Search Day : Click the Calendar icon to display the calendar window, or use the direction buttons to specify the search period of the system log.
 - See the "To use the calendar" page under "Menu Setup > System Setup" in the Table of Contents.
- Search : Specify the date and press this button to display the search result in the log list.

SETTING THE DEVICE

You can configure settings related to camera, storage media, monitor and text.

Camera

To register a camera

You can register a network camera for each channel and make connection between.

Menu > Device > Camera > Cam Registration

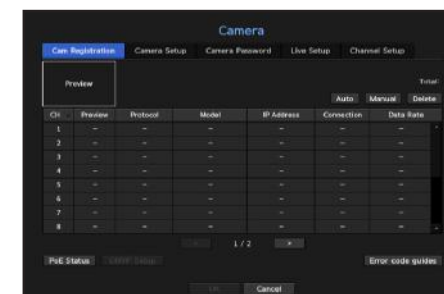
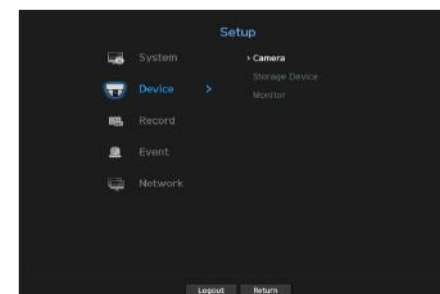

- CH : Click < CH > to display the channel information table.
 - Preview : View the video of the channel as a current image.
 - Camera searched with ONVIF does not provide previews.
 - Protocol : Show the protocol information of a registered network camera.
 - Model : Show the camera model name.
 - IP Address : Display the IP address of a network camera.
 - Connection : Display the connection status.
 - Data Rate : Displays the total amount of data received by the channel.
 - PoE status : Products that support PoE show the current status of PoE that is connected. For products with PoE support, see "NVR products supporting each feature". (Page 4)
 - ONVIF setting : Additional setting is available for an ONVIF protocol camera.
 - Error code guides : Check the details of error codes generated.
-  If you cannot register a camera after initializing the system, check the network setting. As the system is initialized and the network setting is reset, the camera's network bandwidth will be different from the product's network bandwidth, so it will be impossible to register a camera.

To auto-search for and register a network camera

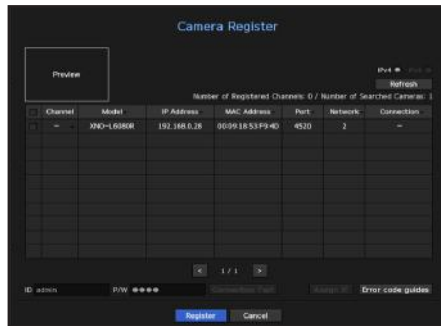

1. In the <Cam Registration> field, click on the <Auto> button.
2. Search for a network camera connected.
 - An already registered camera will be marked in blue in the list.
 - If you search for the camera again or if the IP is an old IP that was not assigned by the DHCP server (such as -192.168.1.100), then press the < Refresh > button to check if a new IP has been assigned. If the camera's IP address is not assigned, click the <Assign IP> button to set the IP address.
3. Select a camera from the camera list to see a preview of its current video feed.
4. Check the checkbox next to a network camera that you want to connect to.
 - You can select all of the network cameras in the list and provide <ID> and <Password> all at once.
 - Click a header at the top of the list to sort the list according to that header.
- ! ▪ If you register a camera using a user account—not admin account—the camera features may be limited.
- When you change the camera ID/password in the camera web viewer, if the camera is already registered in NVR, you also have to change the camera ID/passowrd information registered in NVR.
5. Click the <ID> and <P/W> window to enter <ID> and <P/W> of the selected network camera.
6. Press the <Connection Test> button to make a connection to a camera.
7. Press <Register> to register the selected camera.

To register a camera in the product that supports PoE

- ✍ ▪ You can auto register only when your camera is in factory defaults state.
- Wisenet camera is registered via Wisenet protocol while a third party camera is registered via ONVIF protocol.
- A device running a DHCP server should never be connected to a PoE port or a camera setup port. (e.g. router)
- If your camera uses its own power supply unit, you need to manually register or auto-register the camera.
- For products with PoE support, see "NVR products supporting each feature". (Page 4)

To manually search for and register a network camera



1. In the <Cam Registration> menu, click on the <Manual> button.
2. The Add Manually pane will be displayed.
 - If you double-click a channel not registered on the live screen, the Add Camera Manually popup will appear that allows you to manually register the camera.
3. Select a channel and protocol used to connect to a camera. The input items may differ depending on the selected protocol.
 - Wisenet : Wisenet camera's protocol can be used.
 - ONVIF : Means the camera supports ONVIF protocols. When connecting a camera that its name cannot be found from the list, select <ONVIF>.
- ✍ ▪ When a camera is registered with ONVIF, if the difference in system time between the camera and storage device is 2 minutes or more, you won't be able to register it. In this case, synchronize the camera and storage device time.
- RTSP : Comply with RFC 2326, one of "Real Time Streaming Protocol (RTSP)" for real-time streaming.
4. If you select the <Wisenet> protocol, check options as necessary.
 - Model : Select a camera model.
 - Wisenet Camera : You can register Hanwha Techwin's cameras and encoders.
 - Wisenet Multi-Channel : You can register Hanwha Techwin's multi directional cameras and multi-imager cameras. A multi-channel camera is a camera that has multiple camera modules in one body. Auto-registering your camera to NVR lets you register multiple channels at once. However, if you want to manually register it, you need to register one channel at a time.
 - However, you must select the correct model name of the camera, if it's in the list. Some of obsolete camera models may not be supported.
 - The below models are discontinued. If you register them with ONVIF, some camera functions will be restricted or cause errors. It is recommended you register the Wisenet protocol.
 - SNB-2000, SNB-3000, SNC-B2315, SNC-B2331, SNC-B2335, SNC-B5368, SNC-B5395, SNC-B5399, SNC-570, SNC-1300, SND-460V, SND-560, SND-3080, SND-3080C, SND-3080CF, SND-3080F, SND-3081, SNP-3301, SNP-3301H, SNP-3350, SNP-3370, SNP-3370TH, SNP-3750, SNV-3080, SNP-3430

- Address type : Select an address type of the camera.
 - The supported address type may differ depending on the type of the connected product.
 - Static(IPv4)/Static(IPv6) : Used to provide the IP address of the camera manually.
 - Wisenet DDNS : This is available only if the camera is registered with the Wisenet DDNS(ddns.hanwha-security.com) server. Provide the registered domain for DDNS ID.
Example) http://ddns.hanwha-security.com/snb5000 → provide "snb5000" for Wisenet DDNS
 - URL : Used for URL address input.

 ▪ The DDNS specs supported by each camera can be checked in the user manual of the corresponding camera.

- IP Address : Provide the IP address of the camera.
 - Device Port : Provide the device port of the camera.
 - Depending on the camera type, some device ports will not be supported.
 - HTTP Port : Provide the HTTP port of the camera.
 - ID : Provide the ID of the camera that you want to register.
 - Password : Enter the password of the camera to be registered.
- 5.** Select <ONVIF> or <RTSP> for the protocol and enter your input for each field appears.
- ONVIF : After selecting an address type, set address, ID, password, and details.
 - ID : Enter the camera ID.
 - Password : Enter the camera password.
 - ONVIF Port : Enter the port number when the address type is IPv4 or IPv6.
 - Details : You can set the permission and streaming modes.
 - RTSP: Set access address, ID, password, and details.
 - Access address : Enter your RTSP access address. For more information, see your camera user manual.
 - ID : Enter the camera ID.
 - Password : Enter the camera password.
 - Details : You can set the streaming mode.
-  ▪ If ONVIF or RTSP protocol is selected, you can set the streaming mode in the Details section.
- TCP : The connection to network camera operates in the RTP over TCP mode.
 - UDP : The connection to network camera operates in the RTP over UDP mode.
 - HTTP : The connection to network camera operates in the RTP over TCP (HTTP) mode.
 - HTTPS : The connection to network camera operates in the RTP over TCP (HTTPS) mode.

If you want to check the error details of camera registration

If you failed to register a camera, the reason for the failure will be displayed.

- **Connection failed due to unknown error.** : This message appears if the camera has failed to be registered due to unknown connection status.
- **Due to the camera account locking, access has failed.** : When you enter a wrong ID/password 5 times to login to the camera account, this message is displayed.
Try to log in again after 30 seconds. If the same message appears, you may need to check whether someone has tried to access your camera account from the outside.
- **Connected successfully.** : This message appears if the camera is connected successfully.
- **Incorrect model information. Provide the correct model information.** : This message appears if the model information provided for registering the camera is incorrect.
- **Authentication has failed** : This message appears if the ID or password provided for registering the camera is incorrect.
- **Connection has failed due to excessive concurrent users.** : This message appears if the concurrent user count exceeds the upper limit.
- **Connection has failed due to incorrect HTTP port information.** : This message appears if the HTTP port number of the camera is invalid.
- **Connection has failed. Unknown connection status.** : This message appears if the camera has failed to be connected due to a unknown error.
- **User Model Modification** : When registering a new camera, it is named according to the device's default if user set the model to <Wisenet Camera>. In case if automatic registration fails, user can change the model name of camera to be registered.

To edit camera profile

To change profile, see the "**Setting up camera record profile**" or "**Live setup**" page under "**Menu Setup > Setting the Device**" in the Table of Contents.

-  ▪ In case of NVR, if you set 3 different profiles for live, recording and network profile, one camera will produce video streams accordingly, having different stream formats. Especially, note that the live profile may vary depending on the used screen split mode.
- For cameras, if applied with one profile only, the produced frame rate is fixed as the profile specifies; if applied with multiple profiles, produced video stream's frame rate is not guaranteed. For example, if applied with 2 profiles of 30fps, the camera may transmit streams at 20fps.

ONVIF Setup

In the bottom of the camera addition screen, click on the <ONVIF Setup> button to set additional settings for cameras with the ONVIF protocol.

- You can change the information only if the user account (camera account used for camera registration) is used to read the user information and a connection is made with the admin privilege.

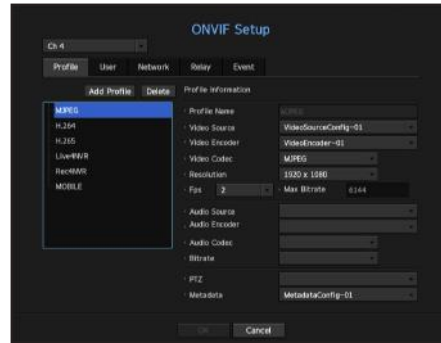

Profile

- CH : You can set the list of channels for a camera registered using the ONVIF protocol.
- Add Profile : You can add camera profile. After adding a profile, click on the <OK> button to add it to the list.
- Delete : After selecting the profile to delete, click on the <Delete> button to delete the selected profile.
- Profile information : You can set the details of the selected profile.

After finishing setting each item, click on the <OK> button to save changes.

User

- Add User : You can add a camera user. After adding a user, click on the <OK> button to add them to the list.
- Delete : After selecting the user to delete, click on the <Delete> button to delete the selected user.
- User Information : You can set the details of the selected user.

Network

You can set the details of the network.

- IP Type : Select from either the IPv4/IPv6 IP types.
- DHCP : Select whether to use the DHCP.
- DNS / NTP Server : Only if the DHCP setting is <ON>, the DHCP checkbox will be activated.
 - If the DHCP is checked, you can manually enter the IP address.

Relay

You can set details of the relay.

- Digital Output : You can select a digital output channel.
- Relay Mode : Select either bi or mono stable modes.
- Relay Idle State : Select either open or closed relay standby modes.
- Delay Time : Select the relay operation waiting time.

Event

You can set details of the event.

- Available events (camera) : It shows the list of all the events supported by a camera by using the ONVIF protocol.
- NVR supported events : You can map the list of events supported by a camera to events that the NVR can detect. There is no default value. It only shows the value sent by a camera.

Camera Setting

You can change the video settings of a registered network camera for each channel.

Menu > Device > Camera > Camera Setup

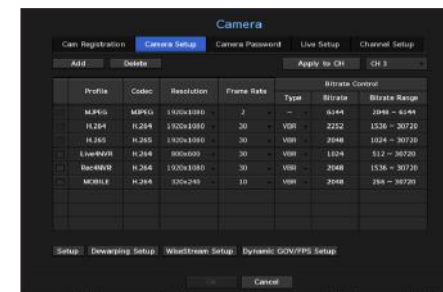

- Add : You can add camera profile. Click on the Add button to launch the addition window. Enter the information and click on the <OK> button to add it to the list.
- Delete : You can delete the selected profile from the list.
- Channel Selection : You can select camera channels to change their video transmission settings.
- Profile : You can check the video profile of the camera connected in the camera setup.
- Codec : You can check the codec for the selected channel.
- Resolution : You can change the resolution of the selected channel.
- Frame Rate : You can change the frame rate of the selected channel.
- Bitrate Control : You can change the bitrate of the selected channel.

menu setup

- If you change specific profile settings for each product, the frame rate's setup range may be changed.
Example If you set the frame rate for the first profile to 30 fps, then the setting range for the second profile may be changed to 15 fps.
- Any settings other than codec, resolution, and frame rates can be changed in the setup menu of the camera web viewer. For camera web viewer, see the "Camera Setup" page under "Setup Viewer > Device" in the Table of Contents. Click <Camera website> button for connection.
- If you change the current profile settings, you may encounter an interrupted playback on the recording or live screen for a certain time.
- Changes made in your camera's setup page will be applied immediately. But any changes made through the camera's online website, it may take up to 3 minutes to apply the changes.

Setup

In the bottom of the camera setting screen, press the <Setup> button to set your camera while watching the live video of the selected camera.

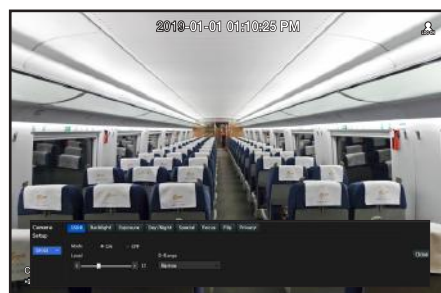

- You can use this feature in the following cases:
 1. A camera connected to Wisenet protocols.
 2. A camera connected with admin privileges.
- For more details on camera settings, refer to the camera user manual. Settings and operational spec vary depending on each camera.
- This function is not supported in some models.

SSDR

If there is a significant difference between the dark and the bright areas, increase the brightness of the dark areas to maintain the level of brightness of the entire area. Mode, level, D-Range can be set.

Backlight

You can view both bright and dark areas. Mode, WDR level, WDR black/white levels can be set.

Exposure

You can adjust the exposure of your camera. You can set brightness, shutter, SSNR, Sens-up, iris/lens, and AGC.

Day/Night

You can change the mode to adjust the color and contrast. You can set modes, switching time, switching brightness, alarm time, alarm input, negative color, simple focus after D/N, and activation time (color).

Special

DIS (shaking compensation), use of Defog levels can be set.

Focus

You can adjust the focus of you camera's video. You can set focus, zoom in, simple focus, and focus reset.

Flip

You can set flip/mirror modes and hallway view.

Privacy

You can set an area to be hidden in the camera image range to protect privacy.

- With a PTZ camera, it is not possible to configure settings, and when it is permitted, the setting area may be incorrect.

After finishing with setting camera, click on the <Close> button to move back to the previous screen.

Dewarping Setup

Press <Dewarping Setup> at the bottom of the camera settings screen and a distortion correction settings window for each channel is prompted.

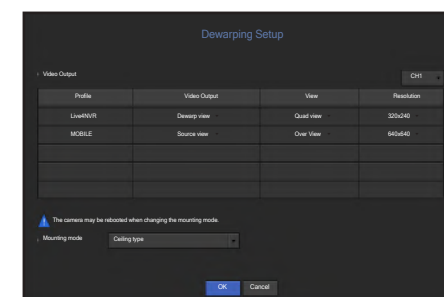
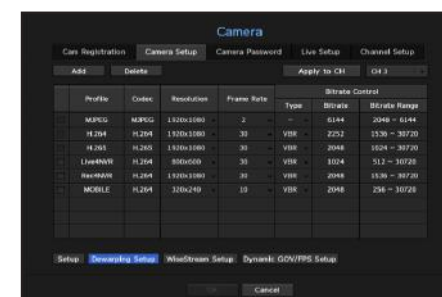

- Profile/View Type: From the profile list in the dewarping setup popup, you can select a view type.
 - You cannot change SourceMJPEG, SourceH264, DewarpMJPEG, or DewarpH264 settings.
- Mounting mode : You can change the fisheye installation type. You can select a view mode from among CEILING/GROUND/WALL depending on the installation location.
 - You can select view modes supported by your camera.
- View : You can change the fisheye view mode of the current screen according to each split section.
- If there is no camera registered in the NVR that supports fisheye view, <Dewarping Setup> will not be available.

How to set WiseStream

Function to analyze the complexity of the video and effectively reduce the data size while maintaining the quality. For details, refer to the camera's help or the product's user guide.

Press the **<WiseStream Setup>** button at the bottom of the camera setup screen to display the WiseStream setting popup window for that channel.

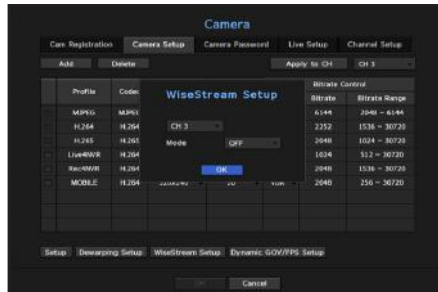

- Channel : You can select the channel to set WiseStream.
- Mode : You can choose the degree of video compression. You can choose either OFF, Low, Medium, or High.

 ■ **<WiseStream Setup>** cannot be executed if there is no camera registered in NVR that supports WiseStream.

Dynamic GOV/FPS setup

Dynamic GOV can be used to automatically change the length of GOV depending on the video condition. For more information, see help for your camera or the product user manual.

At the bottom of the camera setup screen, press the **<Dynamic GOV/FPS Setup>** button to launch the dynamic GOV/FPS setup popup for the channel.



- Profile : Shows the video profile of the connected camera setting.
- Dynamic FPS : Automatically adjusts the frame rate (frames per second) based on the video conditions.
- Dynamic GOV
 - Mode : Set the GOV length to change automatically.
 - Length : Enter the maximum GOV length value to be applied when there is no motion in the video. Minimum GOV value can be set on the camera web page.
 - Range : The range of the input value of **<Length>** is displayed.

 ■ Any profile not supported with the dynamic GOV/FPS setting is marked with '-!'.

Setting Camera Password

You can change the passwords of all registered cameras at once.

Menu > Device > Camera > Camera Password

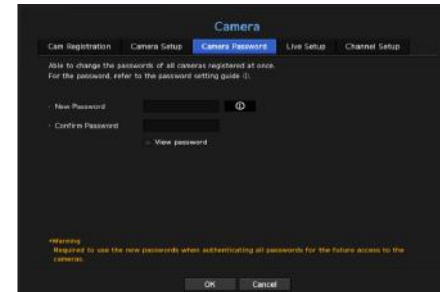

- New Password : Input a new password according to the password setting rules.
- Confirm Password : Input the new password again.

-  ■ If you click **<View password>**, a basic guide for password setup is displayed.
- If **<View password>** is selected, the password is no longer hidden on the screen when you type it.
- A camera password registered with ONVIF and RTSP cannot be changed.

Live Setting

You can change the live transfer settings of the network camera.

Menu > Device > Camera > Live Setup

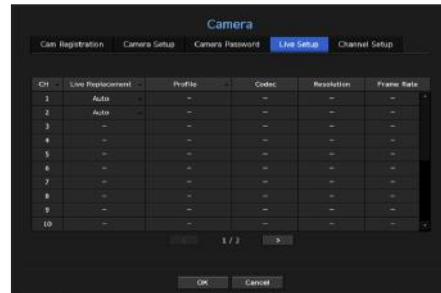

- CH : Click < CH > to display the channel information table.
- Live Replacement : You can select the live profile setup mode.
If you select <Manual>, the profile setup items are enabled, and you can change settings manually.
 - Auto: For the profile for live monitoring, a profile optimized for each split mode is displayed, along with the 'Live4NVR' profile automatically generated at the time of the camera registration.
 - Live4NVR profile default: H.264 800 x 600 30 fps
 - Manual : Live monitoring is performed with the profile selected by the user from the registered camera profiles.
 - Recording : Live monitoring is performed with the profile set for recording.
- Profile : You can set the camera profile.
- Codec : Show the codec of the selected recording profile.
- Resolution : Show the resolution of the selected profile.
- Frame Rate : Show the frame rate of the selected profile.

Channel Setting

You can configure the video settings for each channel.

Menu > Device > Camera > Channel Setup



- Apply to CH : If you select <Apply to CH>, the "Apply to CH" confirmation window will appear. After selecting channels that the settings will be applied to, click on <OK> to apply them to the selected channels.
- Video
 - <ON/OFF> : You can turn ON/OFF the selected channel's camera. If the camera video is turned off, a blank screen is displayed.
 - <Covert1> : Shows information other than the video of the selected channel.
For privacy protection, it does not display the video while the recording continues.
 - <Covert2> : Shows nothing but an empty screen while the recording continues.
- If the channel is set to <Covert1> or <Covert2> mode, the channel's sound is not hearable. However, the channel's sound is recorded if its Audio setting is set to <ON>, even the sound is not heard in Live mode.
- Audio
 - If set to <ON>, you can turn the audio of the channel ON/OFF on the Live screen.
 - If set to <OFF>, the channel's audio is off on the Live screen and not recorded.
- Camera Name : Provide a camera Name. You can enter up to 15 letters including spaces.

Storage Device

You can check information on storage devices.

Device/Format

You can check storage devices and their capacity, usage as well as status. HDD and USB (memory or HDD) can be connected as a storage device.

Menu > Device > Storage Device > Device/Format



- Storage Status : Displays the working status of a storage device.
 - Red : Displays the situation of video loss.
 - Green : Displays the normal situation without video recording losses.
 - Status
 - Full BPS : Displays the current rate of recording.
 - Current Loss Rate : Displays the current recording loss rate.
 - Max Loss Amount : Displays the maximum amount of losses up until now.
 - If loss is continuously generated, check the following.
For more information, see "**Troubleshooting (FAQ)**" in the Appendix.
 - When data is lost due to system failure (reset the rate of data transferred from the camera)
 - When there is a problem in HDD recording performance due to an HDD malfunction (check the HDD error or replace the HDD)
- No. : You can check the designated number for the built-in HDD.
 - If you want to find out about the location corresponding to the HDD number, refer to the <HDD Map>.
- Model : Displays the model name of the built-in HDD.
- Capacity : Displays the amount of storage device use and the full capacity.
- Usage : Designate the purpose of use for a storage device. (However, only the display function is available for RAID)
 - If the state of use is in "**Not Defined**", format the HDD before use.

- Status : Displays the current working condition of a storage device.
To create an HDD alarm for inspection or replacement, see the "**HDD Alarm Setting**" page under "**Menu Setup > Setting the Device**" in the Table of Contents.
 - Normal : It is displayed during normal operation.
 - Inspection : Operating with partial problems.
In the case of the RAID Array, it is displayed when status is displayed as Degraded or Rebuilding.
 - Replacement : It is displayed when you can no longer use it.
In case of the RAID Array, it is displayed when there is a system failure.
 - RAID(?) : Unknown RAID. It is an HDD that used the RAID in the past. Currently, the RAID is not used. If you organize the RAID again, it will be included in the full format. To use the general HDD, you need to format it first.
 - Unknown : The RAID array is installed in the currently used slot, but the HDD does not constitute the RAID.
- Temperature : You can check the temperature of the HDD mounted in the NVR.
- Time : Displays the use time of an HDD.
- Format : Select a device and click on format after which a format confirmation window appears.
Click on the <OK> button to format the selected storage device.



- Formatting will delete all the recording data that has been saved. Be careful.
- While formatting is ongoing, you cannot record video.
- Do not remove a formatting device until it is finished.
- With no RAID Array used, if an HDD used as a RAID is additionally installed but is displayed as "RAID (?)" or "**Not Defined**", format it before use.
- After installing an HDD, if the state of use of the HDD is "**Not Defined**", format the HDD before use (If the warning message persists after formatting, replace the HDD with a new one).

- HDD Map : You can check the location according to the assigned number for the HDDs installed inside.
 - Refer to this when servicing or installing an additional HDD.



- Do not add or remove an HDD while NVR is running. However, you can replace the HDD of the RAID for RAID rebuild.

RAID mode setting

This function is only available for products that support RAID. For products that support RAID, see “**NVR products supporting each feature**”. (Page 4)

If you enable the RAID (Redundant Array of Independent Disks) mode, you can safely recover your data even if your system HDD is damaged.

RAID type

RAID level 1 is supported.

RAID level 1: Maintains the same data in two HDDs consisting an RAID array. So, even if one fails, you can still use the data from the other and recover it.

Menu > Device > Storage Device > RAID

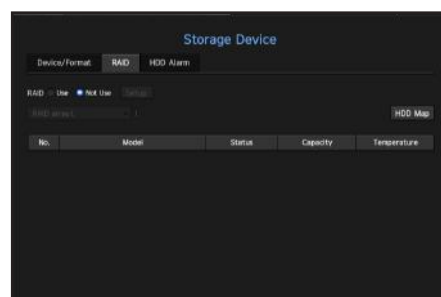

- RAID status : Displays the operational status of the RAID.
 - Active : Signals the fact that the RAID is operating normally.
 - Degraded : It is displayed when the one or more HDDs that make up the RAID are malfunctioning. When the maximum number of HDDs allowed in the RAID level are malfunctioning, if an additional HDD malfunctions, you cannot use or restore the RAID. Immediately, replace the HDD and proceed with restoration.
 - For more information about how to replace the HDD and recover the RAID array, see the "**Recovering RAID Array**" page under "**Menu Setup > Setting the Device**" in the Table of Contents.
 - Rebuilding : Rebuilding: Indicates that the RAID array is in the recovery process. At RAID level 5 or 6, if the max number of HDDs allowed by the RAID level is malfunctioning, and one more HDD caused malfunction during rebuilding, then you cannot recover or use the RAID array.
 - Fail : This means that the RAID cannot be used or restored.
- Disk status : Displays the current operating condition of the HDDs installed in a RAID.
 - Active : Displays that the HDD is operating normally.
 - Faulty : It displays that the HDD is malfunctioning. You need to immediately replace the HDD for smooth recovery of the RAID.
 - Check : A problem occurs on the HDD, requiring replacement or inspection.
- Capacity : It shows the total capacity of the HDDs that composes a RAID.
- Temperature : You can check the temperature of HDD(s) that compose a RAID.

RAID mode setting

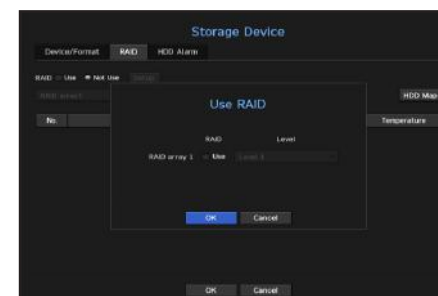

1. Click on the <Use> or <Setup> button.
2. In the use RAID window, select settings of RAID and click on the <OK> button.
 - Use : You can select whether or not to use the RAID mode.
 - Level 1 : Shows the RAID types supported by NVR.
3. It will show the list of HDDs that compose a RAID. In the RAID screen, click on <OK>.
4. The data deletion and system rebooting message window will appear. You can click on the <OK> button to reboot the system for RAID mode setting.
5. When RAID building is complete, select <Setup> - <Device> - <Storage Device> - <RAID> to check the build.
 - If you set the RAID mode to 'Not Use' at RAID level 1, the RAID Array will be disabled.
 - If the status of HDD is displayed as inspected/replaced in the device/format page, you cannot use it to build a RAID.
 - When the RAID mode is in use, it is recommended to use HDDs with the same storage space from the same manufacturer.
 - If you enable or disable the RAID mode, existing data will be deleted. You make sure to backup your data.
 - RAID Array capacity calculation
 - If RAID is configured for level 1, then one array of RAID is allocated with the smallest HDD size.
 - If you use HDDs with different capacity, the HDD with the smallest capacity will be used to build a RAID.

Recovering RAID Array



1. If the HDD number whose <Status> is shown as Faulty or Check is recognized, check the location of HDD to be replaced on the HDD map.
2. Replace the malfunctioning HDD from the NVR with a new HDD.
3. In the "Device > Storage Device > RAID" menu, you can check the recovery progress.

- ! Replace it with the same model of HDD or an HDD of the same capacity from the same manufacturer.
- A HDD used to build the RAID should be one of the recommended models. If it's not possible to use the same model of HDD, then use the HDD with the same capacity from the same manufacturer should be used.
- If you remove the power cord while using the RAID, it can damage it, so be careful. For reliable power, it is recommended you use the UPS.
- A new HDD to be replaced should be one that is not RAID configured.

HDD Alarm Setting

For HDD malfunctions, you can set the inspection alarm output terminal, the replacement alarm output terminal and the alarm time. You can set the alarm behavior for abnormal HDD temperature.

Menu > Device > Storage Device > HDD Alarm

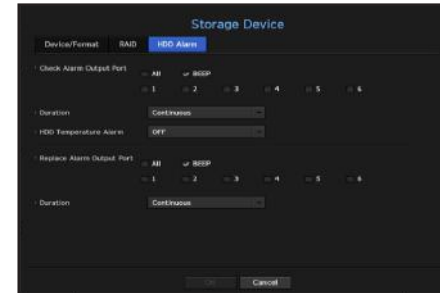

- Alarm
 - If <All> was selected, both beep sound and alarm signal through rear side ports will output.
 - If <BEEP> was selected, a beep will sound.
 - If you select an alarm output terminal number, a signal is displayed on the alarm output terminal at the back. Each product has a different number of alarm output terminals.
 - Check Alarm Output Port : If HDD generates check alarm, the alarm signal will output to the specified alarm output port.
 - HDD Temperature Alarm : When the HDD temperature increases higher than the set temperature, a signal is output to the check alarm output terminal.
 - Replace Alarm Output Port : If HDD generates replace alarm, the alarm signal will output to the specified alarm output port.
 - Duration : Sets the alarm duration for the alarm signal and beep sound.
- ✍ <Check> status means that the HDD is operating but it has problems that require technical examination. (🔧) appears on the Live screen. If a RAID is degraded or rebuilding, <RAID / 🔄> will appear on the live screen.
 - ✍ <Replace> status means that the HDD has defect and requires immediate replacement. (🔪) appears on the Live screen. If a RAID has failed, <RAID / 🚫> will appear on the live screen.

Monitor

You can set the information displayed on the monitor as well as the output system.

Menu > Device > Monitor

Monitor settings

You can set the monitor output related screen displays, switching time, video display, etc.



- Event Display : Sets the dwell time of the event channel display on the monitor when an event occurs. If you set **<Continuous>**, it will keep displaying until you cancel it.
- Display : Displays only checked items on the monitor screen.
- Sequence switching time : Set the automatic switching time for the segmented screen in live mode.
- Video Output: Set the video display resolution.
For products that support an extended monitor, select either **<Clone>** or **<Extend>** mode to set the resolution of **<HDMI>** and **<VGA>**.
 - Clone mode : You can set the video display resolutions of the primary monitor (HDMI) and the secondary monitor (VGA) to the same value. In the Clone mode, if the resolution exceeds 1920 x 1080, the secondary monitor will not display any video.
 - Extended mode : You can set the video display resolutions of the primary monitor (HDMI) and the secondary monitor (VGA) separately.

- If the newly selected resolution does not fit with the monitor, the display won't function properly. In this case, wait until the native resolution is restored and then switch to another resolution of your choice.
- Set up Event Display and Sequence Switching Time in consideration of the network environment time.
- For products that support extended monitor, see **"NVR products supporting each feature"**. (Page 4)

To set an expansion monitor

This function is only available for products that support the use of an extended monitor. For products that support extended monitor, see **"NVR products supporting each feature"**. (Page 4)

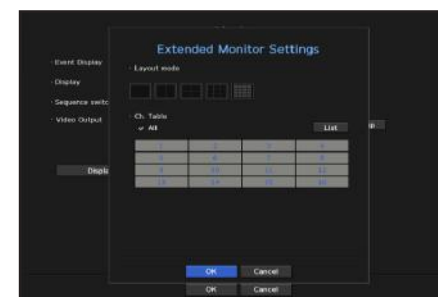

1. Select the Expand mode, then **<Setup>** button to change the layout of the expansion monitor is enabled.
 2. Select split mode in the layout mode.
 3. Select as many channels on the channel table as the number of channels selected in layout mode, and you can view the applicable screens on the monitor.
- If the new resolution does not fit the monitor, the output will not be displayed normally. In this case, wait until the monitor returns to the default resolution and then change to a different resolution.
 - Set up Event Display and Sequence Switching Time in consideration of the network environment time.
 - The profile used for the live output on the extended monitor is **"Live4NVR"**. The highest resolution available is 1280 x 720. If user changes the **"Live4NVR"** profile, the video display from the extended monitor may be affected."
 - The extended monitor's resolution can be set to 1920 x 1080 at the most.
 - If you enable the Clone mode for the monitors, you can use the maximum split mode supported by NVR. If you enable the Extended mode for the monitors, you can use up to the 16-split mode for the secondary monitor.

To adjust the display position

Some monitors may not display information (camera name, icon, time information, etc.) about the NVR, depending on the condition. Then, you can change the display position of the data.

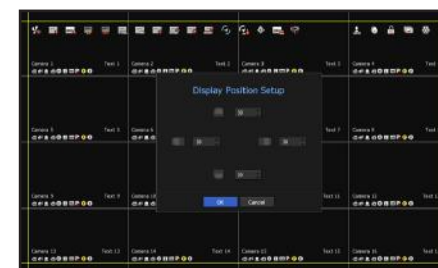

1. From the monitor setup menu, select **<Display Position Setup>**.
2. Using the number button to adjust the screen that is cut off.
3. Press **<OK>**.

SETTING THE RECORDING

You can setup scheduled recording, event recording and other recording related settings.

Recording Schedule

Make your reservation on a date and time to schedule the recording on specified time.

Menu > Record > Recording Schedule

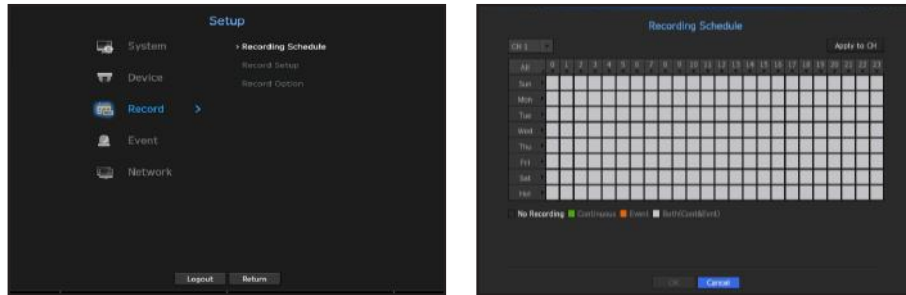

- All : The entire time range (Monday through Sunday including holidays, AM 0~ PM 23) will be reserved with the same recording schedule
- Apply to CH : If you select <Apply to CH>, the "Apply to CH" confirmation pop-up window will appear. After selecting channels that the settings will be applied to, click on <OK> to apply them to the selected channels.

■ Event recording and scheduled recording starts about 3 seconds prior to the event/schedule for guaranteed recording.

Record setting by the color

| Color | Function | Description |
|-------------|----------------|-----------------------------------|
| No Color | No Recording | No schedule / event recording |
| Green () | Continuous | Scheduled recording only |
| Orange () | Event | Event recording only |
| White () | Both(Cont&Evt) | Both scheduled / event recordings |

Each press of a selected cell will cycle through <No Recording>-<Continuous>-<Event>-<Both(Cont&Evt)>.

Record Setup

You can set resolution, FPS, and quality of recordings by channel, and by recording type of standard / event. You can check frame rates and data transfer amount of Full Frame and Key Frame recordings for each channel, and set the transfer limit for recordings.

Menu > Record > Record Setup > NVR



- CH : Click < CH > to display the channel information table.
- Apply to CH : If you select <Apply to CH>, the "Apply to CH" confirmation window will appear. After selecting channels that the settings will be applied to, click on <OK> to apply them to the selected channels.
- Standard, Event : Configures Standard recording and Event recording.
 - FULL : Records all frames fed by the camera.
 - KEY : Records only key frames fed by the camera. Actual recording rate may differ from camera settings. In general, 1 to 2 frames per second are recorded.
 - OFF : No recording is made.
- Frame
 - FULL : Shows the amount of data for all the scene recordings.
 - KEY : Shows the amount of data for the main scene recordings.
- Limit : Set the amount of data allowed for input for each channel.
- Event : When an event occurs, you can set which point you will start or stop recording.
 - Pre : When an event occurs, recording will be started regardless of the time set. If you set it to five seconds, recording will start at five seconds before an event occurs.
 - Post : When an event occurs, recording will continue after the time set. If you set it to five seconds, recording will continue for a further five seconds after an event is finished.
- Audio : Specify whether to record the sound received from the camera or not.

■ If a channel's data transfer exceeds defined allowed limit, then it may affect to other channels, and may force switching to <KEY> recording even when the channel is configured to <FULL> recording mode. For Key Frame recording channels, the icon for limited recording appears on the live screen's top side. But if the sum of the limits is below the max limit, you can still receive the entire frames despite exceeding the permitted bitrates for each channel.

- A channel displayed in yellow indicates that the recorded data is not being transferred from the camera and that the recording is being performed temporarily using another profile on the camera. Check the channel information to see the applied profile to the channel listed in yellow. A channel displayed in orange indicates that the amount of inputted data is greater than the permitted data amount. In this case, it is impossible to record all of the incoming frames. Instead, only part of the frames (1 or 2 frames per second) can be recorded. To resolve this issue, you must set the permitted data amount to be greater than the amount of inputted data. See the note text on the "Record status" page under "Live > Status" in the Table of Contents.

Setting the network camera's recording profile

You can configure the video profile settings for instructing the network camera (connected to each channel) to make recording.

Menu > Record > Record Setup > Camera



- You can configure the settings only for the profiles that are supported by the camera.
 - If the profiles used for recording and network are different, camera's video feed may not comply with the frame rate as specified in the camera.
- CH : Click < CH > to display the channel information table.
 - Profile : You can select the recording profile for selected channel.
 - Codec : You can check the codec for selected channel.
 - Resolution : You can select the resolution for selected channel.
 - Frame Rate : You can set the frame rate for selected recording profile.

Record Option

When the HDD capacity is full, you can set whether to stop recording or start overwriting.

Menu > Record > Record Option

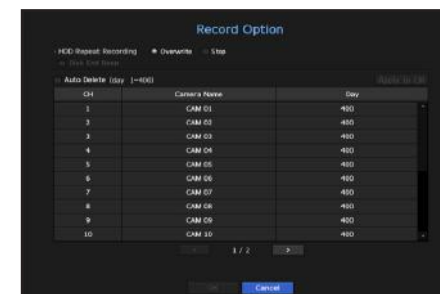

- Disk End Mode : Select a HDD repetitive recording type.
 - Overwrite : If the HDD is full, this will overwrite the existing data and keep recording.
 - Stop : If the HDD is full, this will stop recording automatically.
 - Disk End Beep : If you select <Stop> for the disk end mode, this button will be active. Specify the use of beep when the HDD recording ends. If you check it, the beep will sound on the disk full and the recording stops.
 - Auto Delete : If you check this option, the period list box is active. Specify the deletion period to delete any earlier data than the specified date. However, you can search for data from the current time to the selected date.
 - If you select <Overwrite> as a method to end recording, the button is enabled.
 - You can select a channel and set a different recording duration for each channel.
 - Apply to CH : If you select <Apply to CH>, a confirmation dialog window is opened. Select a channel to apply the applicable settings then press <OK>. The settings will be applied to the selected channel.
- ! ■ If you press <OK> when you have completed your settings, all the existing data earlier than the specified period will be deleted automatically. So it is recommend to backup the previous data if necessary for later use.

SETTING THE EVENT

You can make the setup for record in case of sensor detection, camera event or video loss detection.

Sensor Detection

You can set the sensor's operating condition and connected camera, as well as alarm output and its duration.

Menu > Event > Sensor Detection

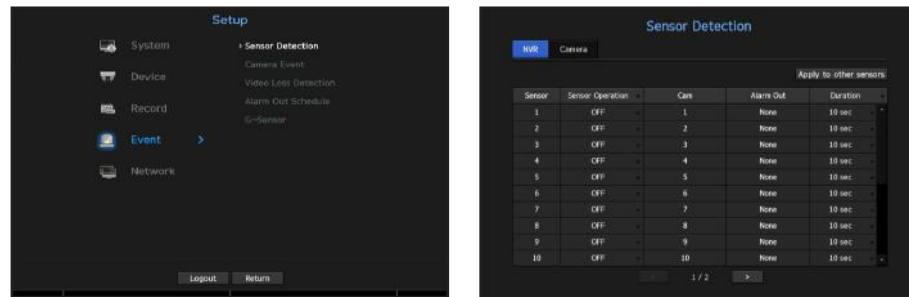

- **Apply to other sensors** : If you select <Apply to other sensors>, the "Apply to other sensors" confirmation window will appear. After selecting channels that the settings will be applied to, click on <OK> to apply them to the selected channels.
 - **Sensor Operation** : Sets the operation mode of sensors.
 - <N.O (Normal Open)> : Sensor is opened. If the sensor is closed, it generates alarm.
 - <N.C (Normal Close)> : Sensor is closed. If the sensor is open, it generates alarm.
 - **Cam** : Select a channel to be connected to the sensor. If selected camera, "Cam Preset setup" window appears. Select a channel and setup the preset.
 - Preset setup can be done in PTZ mode.
 - **Alarm out** : Sets the alarm output method.
 - For alarm output, see the "HDD Alarm Setting" in "Menu Setup > Setting the Device" in the Table of Contents.
 - **Duration** : Sets the duration of alarm signal and alarm sound.
-  If you select <Camera> tab, you can configure the sensor operation settings of the network camera connected to each channel.
 - If the connected network camera that has configured the alarm in/out settings triggers an alarm, NVR will perform the alarm out.

Camera Event

You can set the activation of events (motion detection, video analysis, audio event) sent from the camera, alarm output method and alarm time.

Menu > Event > Camera Event

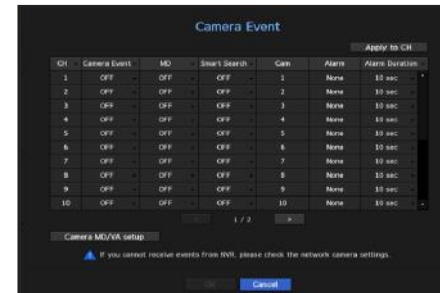

- **Apply to CH** : If you select <Apply to CH>, the "Apply to CH" confirmation window will appear. After selecting channels that the settings will be applied to, click on <OK> to apply them to the selected channels.
- **CH** : Click <CH> to display the channel information table.
- **Camera Event** : Select whether to use an event detection.
- **MD** : You can specify whether to receive an event of camera's motion detection in the storage device.
 - To receive an event of camera's motion detection, you need to enable the camera motion detection.
- **Smart Search** : Enables or disables the Smart Search option.
 - To use the smart search function, the smart search option must be set to <ON>. See the "Smart Search" page under "Search & Play > Search" in the Table of Contents.
- **Cam** : Select an event detection channel. If you select a camera item, the "Camera preset" screen will appear. Select a channel to connect and set the preset.
 - You can set the preset in PTZ mode.
- **Alarm** : Select the method for alarm output.
 - For alarm output, see the "HDD Alarm Setting" in "Menu Setup > Setting the Device" in the Table of Contents.

- Alarm Duration : Set the duration of alarm.
- Camera MD/VA setup : You can set the detailed setting of motion detection for a network camera connected.

In the mode, you can set motion detection or video analysis.



Motion detection setup

- Area : Click the Setup button to set a motion detection area.
- MD Type : You can set a detection area and a detection excluded area.
- Object Size : Click the Setup button to set the size of object whose motion is to be detected.
- Detection Result Overlay : You can overlay the detection area over video.
- Activation time : You can set the activation time for motion detection.
 - Always : Detects motion regardless of time.
 - Schedule : Detect motion only during the set period.
- Motion Region : You can set the detection sensitivity, detection levels, and alarm time for each motion detection area.
 - Detection Level : You can set the basic level required for motion detection. You can set the level for each detection area specified in **[Area]**. If a motion value is bigger than the set level, then a motion detection event is triggered.
 - Sensitivity : You can set sensitivity required for motion detection for each area. Set a lower sensitivity for an environment where the background and an object are clearly distinguishable and a higher sensitivity for an environment where the background and an object are not clearly distinguishable.
 - Alarm Time : You can set the minimum observation time for each area, which is needed to trigger an event after motion detection.

Video Analysis Setup

- Area: Click the Setup button to set a video analysis area.
 - In VA Type, you can set a virtual line, virtual area, and detection excluded area.
 - Object Size: Click the Setup button to set the size of object whose motion is to be detected.
 - Sensitivity: You can set the motion detection sensitivity for the virtual line and the virtual area.
 - Detection Result Overlay: You can overlay the detection area over video.
 - Activation time: You can set the activation time to recognize motion analysis.
 - Always: Detects motion analysis regardless of time.
 - Schedule: Detects motion analysis only during the set period.
 - Virtual Area: You can set the details of virtual areas to fit your purposes.
 - Intrusion: Creates an event when the motion of an object in the designated area is detected.
 - Cam Entering: Creates an event when a moving object enters into the target area from the outside.
 - Cam Exiting: Creates an event when a user goes out of the target area.
 - Cam Appearing/Disappearing: When an object which does not exist inside the area designated by the user appears inside the area without passing the area line and remains for a certain period of time, or if an object which exists inside the area disappears, an event is created.
 - Loitering: Creates an event when the motion of a loitering object in the virtual area is detected.
-  ■ Minimum Duration (sec): You can set the minimum time required to create an event after object detection for each virtual area. If an object keeps being detected over the set period, an event is created.

Detection-excluded area/Non-detection area setup

In the virtual line and area, you can set areas to exclude motion detection from.

-  ■ Area Initialization: You can clear all the set areas.
- Add: You can create an event area within an area.
- The camera MD/VA setup is applied to the camera setting.
- Each camera product support different features. For more information, see the camera manual or help.

Video Loss Detection

You can set the camera so that the camera can trigger the alarm if it is disconnected or the video is lost due to unstable network connection.

Menu > Event > Video Loss Detection

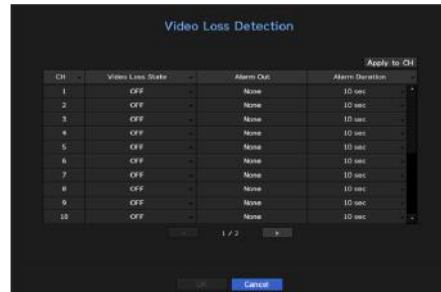

- Apply to CH : If you select <Apply to CH>, the "Apply to CH" confirmation window will appear. After selecting channels that the settings will be applied to, click on <OK> to apply them to the selected channels.
- CH : Click <CH> to display the channel information table.
- Video Loss State : Specify the use of video loss detection.
- Alarm Out : Select an alarm output method.
 - For alarm output, see the "HDD Alarm Setting" in "Menu Setup > Setting the Device" in the Table of Contents.
- Alarm Duration : Specify the duration of the alarm output with the beep.

Alarm Out Schedule

You can set the conditions and operating hours for scheduled alarms.

Menu > Event > Alarm Out Schedule

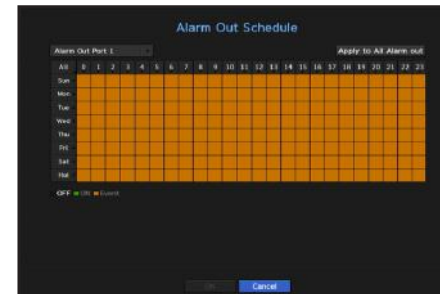

- Alarm Out : Sets the alarm output method.
 - For alarm output, see the "HDD Alarm Setting" in "Menu Setup > Setting the Device" in the Table of Contents.
 - <ON> : Marked in green, and always generates alarm on scheduled time.
 - <OFF> : Marked in black, no alarm is generated even if an event occurs.
 - <Event Sync> : Marked in orange, generates alarm only when an event occurs.
- Apply to All Alarm out : Applies the configured schedule to all alarms.
 - When the alarm is generated on the scheduled time, you can stop the alarm by canceling the schedule.

G sensor

This function sets events and alarms to be generated according to vehicle movement.

- The time of occurrence can be checked in the event log. For information on Event Log, see the "Log Information" section under "Menu Setup > System Setup" in the table of contents.
- After the email setting, G sensor event occurrences can be sent. See the "E-mail" section under "Menu Setup > Network Configuration" in the table of contents.

Menu > Event > G-Sensor



- G Sensor is used. : Checks whether G sensor is used or not.
- Sensitivity : Sets the sensitivity level (Low/Medium/High) for G sensor output. The higher the sensitivity level, the more frequent the G sensor events.
- Alarm out Setup
 - If <All> was selected, both beep sound and alarm signal through rear side ports will output.
 - If <BEEP> was selected, a beep will sound.
 - If you select an alarm output terminal number, a signal is displayed on the alarm output terminal at the back. Each product has a different number of alarm output terminals.
- Alarm Duration : Sets the alarm duration for the alarm signal and beep sound.

- The G sensor event does not occur if the control box is not connected to the vehicle.

NETWORK CONFIGURATION

It provides networked monitoring of Live screen from a remote place, and supports mail forwarding function with events. You can configure the network environment which enables such functions.

Interface

You can set the network connection route and protocol.

Setting a network connection

Sets the protocol and environment of the network.

Menu > Network > Interface

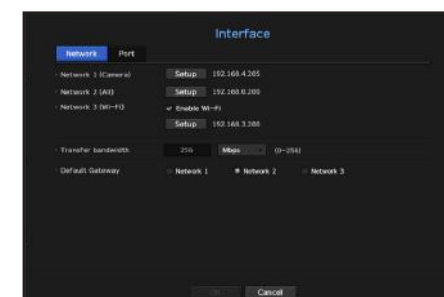
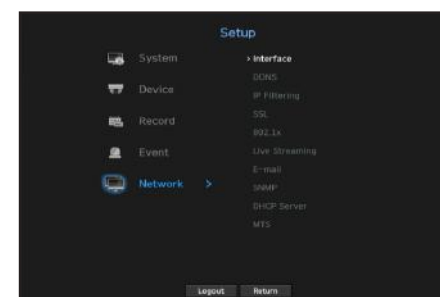

- Network : Each NVR product supports a different number of network ports. If it supports two or more network ports, you can set the network for each function as follows.
- Camera : Can be used as a port for connecting a camera. If you connect a camera, then the camera video will be transmitted. Using the network information, you can access the web viewer.
 - If a UTP cable is used for connection, (UTP) is displayed; if a fiber optic cable, (Optic).
- Viewer : Can be used as a port transmitting video to the web viewer. If you access the network information on your browser, then you can remotely monitor video in your web viewer.
- Wi-Fi : Port to connect to external Wi-Fi. Wi-Fi port is used for backup. For the maximum performance of Wi-Fi backup, see Wi-Fi Backup Performance on the Product Specification Manual.
- All : Can be used as a shared port for the camera and web viewer connection.
 - IP Type : Select the type of network access.
 - IP Address, Subnet Mask, Gateway, DNS
 - Static : IP address, subnet mask, gateway, and DNS can be directly entered.
 - DHCP : IP address, subnet mask, gateway, and DNS can be automatically set.
 - PPPoE : IP address, subnet mask, gateway, and DNS can be automatically set.
 - SSID is displayed above the IP address in the case of Wi-Fi.
 - User ID, Password : To set the access mode to PPPoE, enter the "User ID" and "Password" registered to PPPoE.
- Transfer Bandwidth : Enter the max data rate for transfer.
- Default Gateway : Can set the default gateway. If there are multiple network ports, set one of them as the default gateway.

- The DNS values of <DHCP> and <PPPoE> can be directly entered only if you have selected <Manual>.

Connecting and Setting the Network

Networking may differ from the connection method, check your environment before setting the connection mode.

When no router is used

• Static mode

- Internet connection : Static IP, leased line, and LAN environments allows connection between the NVR and remote user.
- NVR Network Settings : Set the <Network> in <Interface> menu of the connected NVR to <Static>.
 - Consult your network manager for IP, Gateway and Subnet Mask.

• DHCP mode

- Internet connection : Connect the NVR directly to a cable modem, DHCP ADSL modem or FTTH network.
- NVR Network Settings : Set the <Network> in <Interface> menu of the connected NVR to <DHCP>.

• PPPoE

- Internet connection : An PPPoE modem is directly connected to the NVR, where the PPPoE connection requires user ID and password.
- NVR Network Settings : Set the <Network> in <Interface> menu of the connected NVR to <PPPoE>.
 - PPPoE <User ID> and <Password> should be the same to the PPPoE user information. If you don't know the ID and password, consult your PPPoE service provider.

When a router is used

- ! ▪ To avoid IP address conflict with the NVR's static IP, check followings :

• Setting the NVR with a static IP

- Internet connection : You can connect the NVR to a router which is connected to an PPPoE/Cable modem or a router in a Local Area Network (LAN) environment.

• Setting the NVR Network

1. Set the <Network> in <Interface> menu of the connected NVR to <Static>.
2. Check whether the set IP address is in the static IP range provided by the Broadband Router. IP Address, Gateway, and Subnet Mask : Consult your network manager.
 - Check whether the set IP address is in the static IP range provided by the Broadband Router.

- ! ▪ If a DHCP server is configured with starting address (192.168.0.100) and end address (192.168.0.200), you should set the IP address out of the configured DHCP range (192.168.0.2 ~ 192.168.0.99 and 192.168.0.201 ~ 192.168.0.254).

3. Check the Gateway address and subnet mask are equal to those set in the Broadband Router.

• Setting the DHCP IP Address of the Broadband Router

1. To access the Broadband Router's configurations, open a web browser on the local PC that is connected to the Broadband Router and enter the router's address (ex : http://192.168.1.1).
2. At this stage, make the local PC's windows network configurations to the below example :

Example) IP : 192.168.1.2
 Subnet Mask : 255.255.255.0
 Gateway : 192.168.1.1

- Once connected to the Broadband Router, it prompts with password. While entering nothing to the User Name field, enter "admin" into the password field and press <OK> to access the router configurations.
- Access the router's DHCP configuration menu and set its DHCP server activation, and provide the start and end address. Set the start address (192.168.0.100) and end address (192.168.0.200).



- Above steps may differ from the router devices depending on the manufacturer.

Wi-Fi Setup

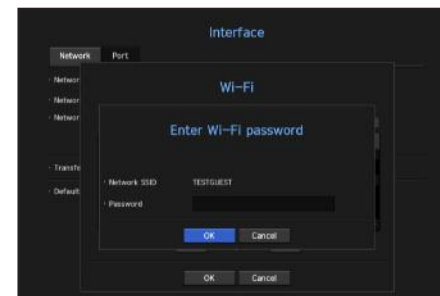

1. Click the <Setup> button.
 - If the Settings button is disabled, tick the <Enable Wi-Fi> checkbox on the right.
2. Select the IP type and click the <Wi-Fi Settings> button. A list of discovered Wi-Fi networks is displayed.
3. If you select a Wi-Fi network to connect to from the list, the password input window appears.
4. Enter the password and click <OK>. Wi-Fi is connected.



- The transmission range of the wireless signal may weaken if heavy obstructions, such as concrete, brick, or metal walls are between the NVR and Router.
- If there are multiple Wi-Fi routers and devices in your environment, it may reduce the wireless bandwidth available. Weak network bandwidth may reduce the videoquality or video loss.
- For Wi-Fi specification of each model, see the Product Specification Manual.

Port Setting

Menu > Network > Interface > Port



- Protocol Type : Select the protocol type among TCP, UDP - Unicast and UDP - Multicast.
- Device Port : Enter the connectable port number. Initially, <554> is set.
 - TCP : It has better stability and lower speed when compared to UDP, and recommended for internet environments.
- UDP Port : Initially, <8000~8159> is set. It increases / decreases by 160.
 - UDP : It has less stability and faster speed when compared to TCP, and recommended for local area network (LAN) environments.
- Multicast IP Address : User can directly input.
- Multicast TTL : Select from 0 ~ 255. Initial value for the TTL is set to <5>.
- HTTP Port : Enter the port number for the Web Viewer. Initially, it is set to <80>.
- HTTPS Port : In this version, the security of HTTP (web communication protocol) is enhanced. The initial port is <443>.
- Cam Proxy Port : Sets the camera proxy port. The default is <10001>.
- Send SSL : Select this option to send SSL.
- Backup Bandwidth : Select the degree of backup bandwidth.

DDNS

If a remote user accesses the network, you can set whether or not to use DDNS and the site to be connected.

Menu > Network > DDNS

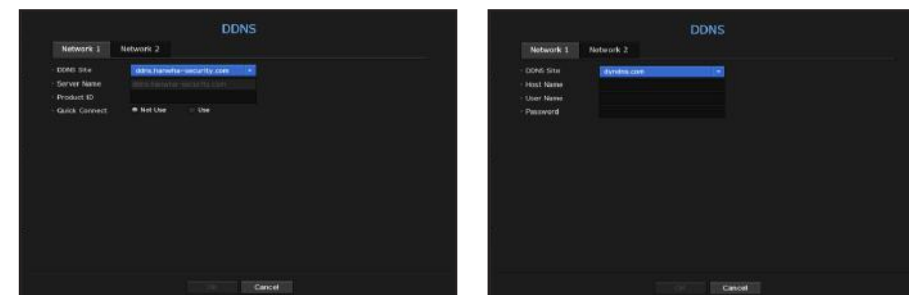

- DDNS Site : Specify the use of DDNS and select a site that you registered.
 - Server Name : Enter the server name registered with the DDNS site.
 - Product ID : Enter the DDNS site user name.
 - Host Name : Enter the hostname registered with the DDNS site.
 - User Name : Enter the user name registered with the DDNS site.
 - Password : Enter the user password registered with the DDNS site.
- ✎ See "Using virtual keyboard" in the Appendix.
- If you select <OFF>, the input box will be inactive.
 - If you select <ddns.hanwha-security.com>, the host name input box will be inactive.
- Quick Connect : Appears if the <ddns.hanwha-security.com> is selected for a <DDNS Site>. To use the function, set to <Use> after connecting the NVR to a UPnP router.

- ✎ If canceled during Quick Connect configuration, it automatically switches to <Not Use> and saved.
- If you are setting up a port that is already in use, then the connection might fail. Check the port setup of your router.
 - Server name, product ID, and quick connect can be displayed if you set <DDNS Site> to <ddns.hanwha-security.com>.
 - DDNS is a short form of Dynamic Domain Naming System.
 DNS (Domain Name System) is a service that routes a domain name consisting of user friendly characters (ex : www.google.com) to an IP address consisting of numbers (64.233.189.104).
 DDNS (Dynamic DNS) is a service that registers a domain name and the floating IP address with the DDNS server so that the domain name can be routed to the IP address even if the IP is changed in a dynamic IP system.

To check Quick Connect status

A progress bar and its message appears for a Quick Connect.

- **Quick Connect Success** : Message for a successful connection.
- **Invalid Network Configuration** : Message appears if the network configuration is not valid. Check the configuration.
- **Please enable UPnP function of the router** : Message appears if the router requires UPnP function enabled.
- **Failed to find the router** : Message appears if the router is not found. Check the router's configurations.
- **Please restart the router** : Message appears if the router should be restarted.

DDNS Setting

- **Setting DDNS in the NVR**

In the <Protocol> menu of the connected NVR, set <Protocol Type>.

- The Protocol type can only be set to TCP.

- **DDNS Settings of the Router**

Select the corresponding menu for the network transfer protocol of the router.

- **Setting up UPnP of Router**

Refer to the router's documentation to enable the UPnP function of the router.

IP Filtering

You can prepare the list of IP addresses to allow or block access to a specific IP address.

Menu > Network > IP Filtering

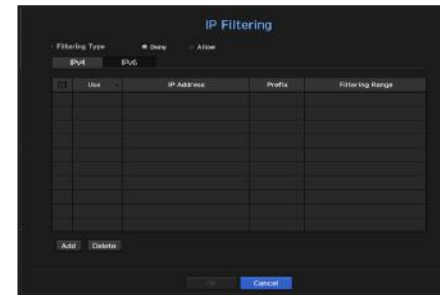

- Filtering Type :
 - Deny : If you select reject, access to the registered IP address will be limited.
 - Allow : If you choose permit, then they can only access the registered IP addresses.
 - Use : Select the checkbox for the IP address that will use IP filtering.
 - IP Address : Enter the IP address for filtering.
 - Filtering Range : If you enter an IP address or prefix, then the range of IP addresses blocked or permitted will be displayed.
- ! ■ If a camera's IP address is not included in the Permit list or is in the Reject list access to it will be rejected.
- For IPv4, camera IP filtering through PoE port is not immediately applied. (Previous connections are maintained, and filtering is applied on next login.)

SSL

You can select a security connection system or install public certificates.

Menu > Network > SSL

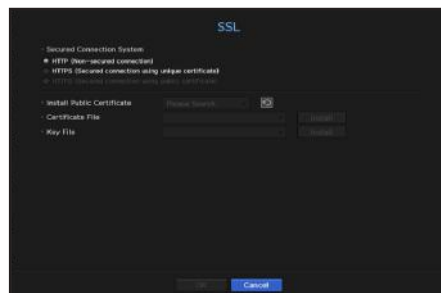

- Secured Connection System : You can select a type of security connection system.
 - HTTP (Non-secured connection)
 - HTTPS (Secured connection using unique certificate)
 - HTTPS (Secured connection using public certificate)

! If the NVR device is connected to the external internet or installed in an environment with high priority for security, making a secure connection is recommended.

- Install Public Certificate : You can scan and register public certificates to be installed. If you want to use a certificate, you need to install a certificate file along with and an encryption file.
 - The <HTTPS (Secured connection using public certificate)> menu can be selected only if there is a registered public certificate.

802.1x

When connecting to a network, you can select whether to use the 802.1x protocol and install a corresponding certificate.

802.1x is a certificate system for the server and the client. It can guarantee robust performance against hacking into the Tx/Rx network data, virus or information leaks.

By using this system, you can block access from a client who is not certified and only allow communication to certified users and thus increase the level of security.

Menu > Network > 802.1x



- EAPOL Version : Select the EAPOL version to be used as protocol.
 - Some switch hubs will not operate if you set them to version <2>. Select version <1>.
 - ID : Enter the ID provided by the RADIUS server administrator.
 - If the entered ID does not match the ID of the client's certificate, it won't be processed properly.
 - Password : Enter the password provided by the RADIUS server administrator.
 - If the password you entered does not match that of the client's private key, it won't be processed properly.
 - Certificates : Search for a device. Click on <Rescan> to search for a device again.
 - CA Certificate : Select this only if your public certificate includes the public key.
 - Client Certificate : Select if the public certificate includes a client's authentication key.
 - Client Private Key : Select it if the public certificate contains the client private key.
- ☞ For successful implementation of the 802.1x operating environment, the administrator must use the RADIUS server. In addition, the switch hub connected to the server must be a device that supports 802.1x.
- If the time setting of the RADIUS server, the switch hub and an NVR device do not match, communication between them can fail.
 - If a password is assigned to the client's private key, the server administrator should confirm the ID and password. The ID and password allow up to 30 characters each. (But it only supports letters, numbers and special characters ("-", "_", ".," 3 types) only. Accessing non password-protected files is allowed without entering a password.
 - The 802.1x protocol adopted by the NVR is EAP-TLS.
 - You need to install all three certificates to use 802.1x.

Live Streaming Setting

You can set the video profile transmitted to the network.

In the "**Device > Camera > Live setup**" menu, if you set live replacement to **<Manual>**, then the live streaming profile is used as the output of the extended monitor.

Menu > Network > Live Streaming



- Profile : Select a network profile for the connected camera.
- Codec : Show the codec information for the selected network profile.
- Resolution : Display the resolution for the selected network profile.
- Frame Rate : Shows the selected network profile's frame rates.



- If the profiles used for network and recording are different, camera's video feed may not comply with the frame rate as specified in the camera.

E-mail

You can send an e-mail to a NVR-registered user at a specific time interval, or if an event occurs.

SMTP Setting

Sets the SMTP mail server.

Menu > Network > E-mail > SMTP

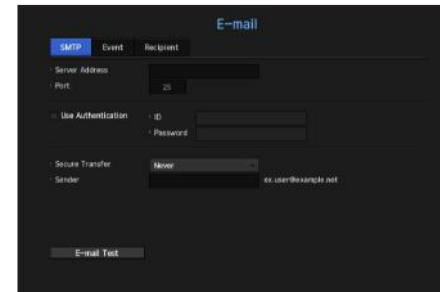

- Server Address : Enter the SMTP server address to connect to.
- Port : Sets the communication port.
- Use Authentication : Check this if the SMTP server uses user authentication. The account input box will be activated.
- ID : Enter a ID to use authentication when connecting to the SMTP server.
- Password : Enter the password of the SMTP server user.
- Secure Transfer : Select one from **<Never>** and **<TLS (if available)>**.
- Sender : Use the virtual keyboard to enter the sender's e-mail address.
 - See "**Using virtual keyboard**" in the Appendix.
- E-mail Test : Conducts the test on the server settings.

Event Setting

You can set the interval and type of the event that will be sent to the user.

Menu > Network > E-mail > Event

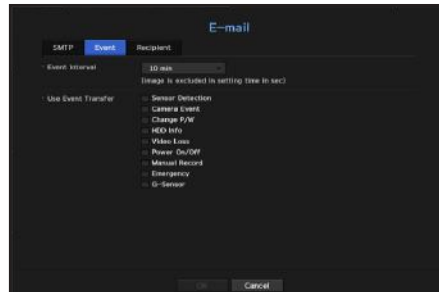



- Event Interval : Set the event interval.
 - If a series of events occurs, the e-mail will be sent at the specified interval, not on each event.
- Use Event Transfer : Select an event type to send if an event occurs.
If the selected event occurs, the e-mail will be sent to the group that has the recipient authority.

Recipient Setting

You can create a group and add users to it or; you can delete users and change a group.

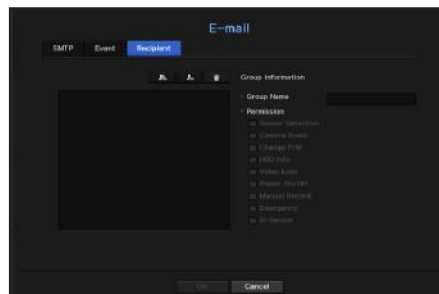
Menu > Network > E-mail > Recipient



- Click on <  > to add a group.
Select a group name and the privilege.
- Select a recipient group to receive emails.
If a group is added, it will appear in the group list.
- Click on <  > to add a recipient.
Select a group and enter names and email addresses.
If a group is created, you can add a recipient.
 - For information on entering user name and email address, see "Using virtual keyboard" in the Appendix.

SNMP

Using the SNMP protocol, the system or network administrator can monitor the network devices remotely as well as the operating environment.

Menu > Network > SNMP



- Enable SNMP v1 : SNMP v1 is used.
- Enable SNMP v2c : SNMP v2c is used.
 - Read Community : Enter the name of read-only community to access the SNMP information. By default it is set to <private>.
 - Write Community : Enter the name of write-only community to access the SNMP information. By default, it is set to <public>.
- Enable SNMP v3 : SNMP version 3 is used.
 - Password : Set the initial user password for SNMP version 3.
- Enable SNMP Traps : SNMP trap is used to send important events and conditions to the Admin System.
 - Trap Manager : Enter the IP address to which messages will be sent.

- ! ▪ SNMP v3 can be set only if the security connection method is set to HTTPS mode.
See the "SSL" page under "Menu Setup > Network Configuration" in the Table of Contents.

DHCP Server

You can set the internal DHCP server and assign an IP address to the network camera.

Network Setting

Menu > Network > DHCP Server > Network

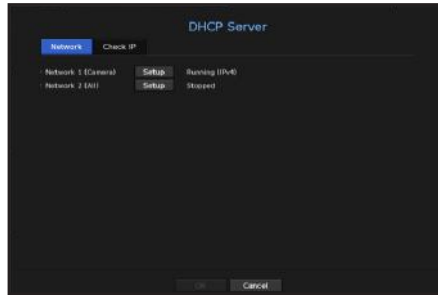

- Network : Select <Setup>, and you can set the IP range operated by the server and time.

To set the DHCP server

1. On the DHCP Server Setup window, click <Setup>.
2. Select <Run> in the <Status> field.
3. Enter the starting IP and end IP in the <IP Range> field.
4. Fill in the <IP Lease Time> field.
5. Click <OK>.
 - The IP range entered is set as the DHCP server address of the network.

Check IP

You can check the IP address assigned to the current DHCP server, MAC address, and the connected network port information.

Menu > Network > DHCP Server > Check IP



- Network : If the product supports multiple network ports, you can select from the many network ports.

MTS

Vehicle information, real-time location, events and video are transmitted to SSM-MTS (Mobile Tracking System).

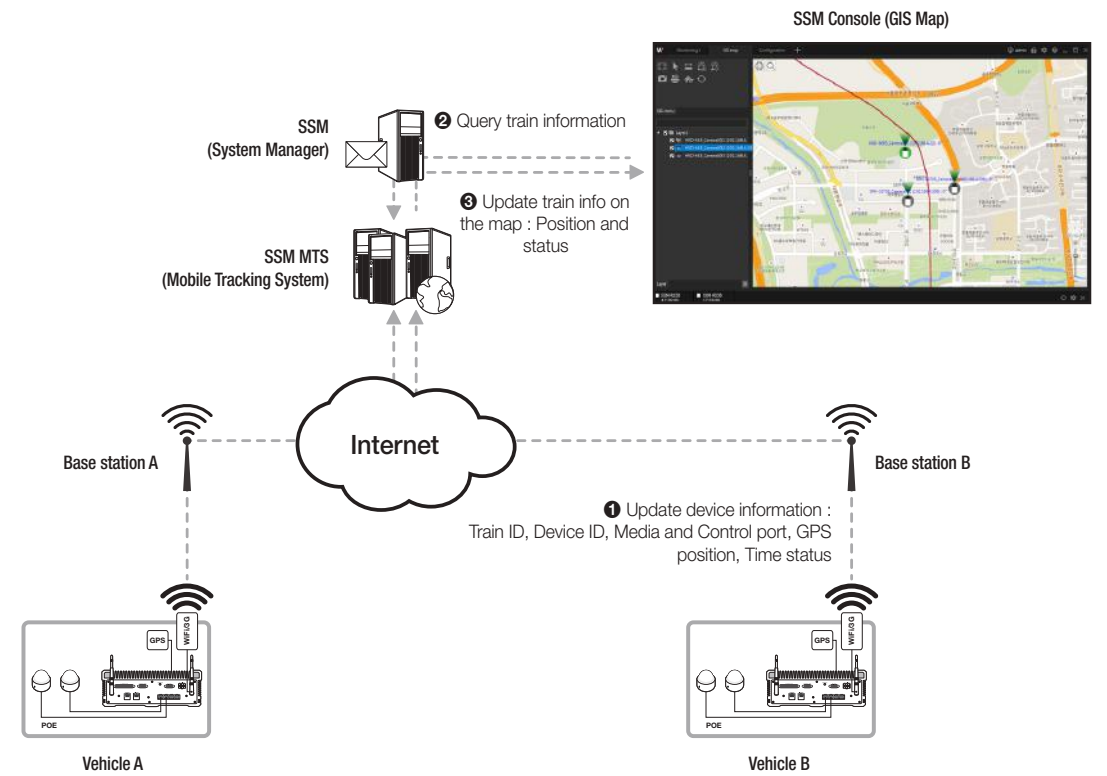

MTS

Sets the MTS server address and whether tracking, event notification, and JPEG push are enabled.

Menu > Network > MTS

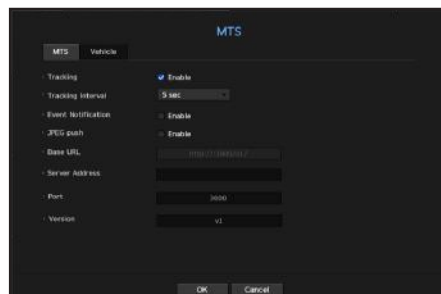

- Tracking : Chooses whether or not to send location.
- Tracking Interval : Selects the location transmission interval.
- Event Notification : Selects whether to send events.
- JPEG Push : When live monitoring is requested from a remote site, the video is transmitted in JPEG format. The fps and resolution of the transmitted video follow the settings of the first profile (MJPEG) of a selected channel on transmission request.
- Base URL : The MTS server address configured when <server address>, <port>, and <version> are entered.
- Server Address : The URL of the MTS server.
- Port : The port number of MTS.
- Version : Enter the communication protocol version of MTS.

- ✎ Operates only when NVR is registered in MTS. If the information is not being delivered even though the NVR was registered, check the default URL.
 - If no location information is received at system startup, the latitude and longitude are delivered as 0 degrees, 0 minutes, and 0 seconds.
 - If the location information reception is lost, the last received location information is transmitted.
 - Only cameras that support SUNAPI provide the JPEG push function.

Vehicle

Sets the vehicle information to be transferred to MTS.

Menu > Network > MTS > Vehicle

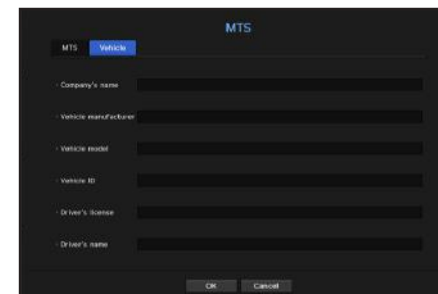

- Company's name : Enter the company name where the vehicle is registered.
- Vehicle manufacturer : Enter the manufacturer name of the vehicle.
- Vehicle model : Enter the vehicle model.
- Vehicle ID : Enter the license plate number.
- Driver's license : Enter the driver's license number.
- Driver's name : Enter the driver name.

SEARCH

You can perform the search for recorded data by the time or by the search criteria such as an event. You can access the **<Search>** menu directly in Live mode.

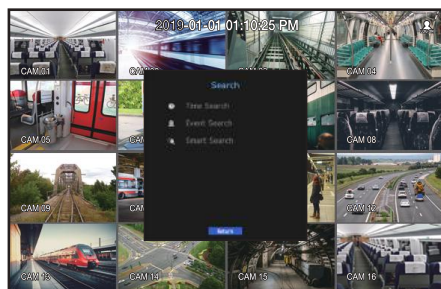

1. In live mode, right click with your mouse button. The Live menu appears.
2. Select **<Search>**.
3. The Search menu should appear.
4. The search can be restricted by the Auto Delete function. See the "Record Option" page under "Menu Setup > Setting the Recording" in the Table of Contents.

-  Overlapped data : It only appears if there exists overlapped data on a certain time, produced due to the change of NVR's time setup. The latest data comes first, from **<List0>**. It does not appear in **<Backup Search>**.
 - The search time is based on the time specified by NVR.

Time Search

You can search for recorded data of a desired time. The displayed time is based on the local time zone and the daylight saving time (DST). Therefore, data recorded at the same time from different areas may differ based on the time zone and the DST.

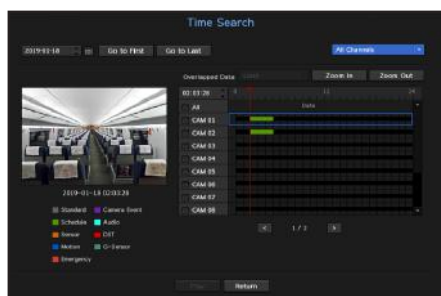

1. Select **<Time Search>** in the **<Search>** menu.
2. In the date selection window, click on the **< >** button to select a search date.
 - See the "To use the calendar" page under "Menu Setup > System Setup" in the Table of Contents.

3. The record data on the specific date will be listed. The display bar is different according to the data type. So check the data type for the color in the left pane.

-  If DST (Daylight Saving Time) is configured, overlapping multiple recordings may be produced for a certain moment of time. Such a time section is distinguished with red color to mark DST section.

- Go to First : Move to the earliest recording date.
 - Go to Last : Move to the latest recording date.
 - All Channels : If you select a list, you can search for recorded videos of layout specified by you. By default, it will show search results for all channels.
 - Time : Enter a time to perform the search or use the up/down button **< >** to select one.
 - Zoom In : The map enlarges in detail. It will switch in the sequence of 24hours - 12 hours - 6 hours - 2hours - 1hour.
 - Zoom Out : The map will switch in the reverse order of the detailed mode above. It will switch in the sequence of 1hour - 2 hours - 6 hours - 12 hours - 24 hours.
 - Preview screen : After selecting **<Channels>**, mouse-click or mouse-drag a desired time in timeline to view the still image at the time.
 - If the selected channel does not contain any recorded data, it will be marked black.
- 4. Select a data item and click **<Play>**. The recorded video for the selected channel will play.
 - Just like the timeline in time search, the timeline of the playback screen will exhibit different colors depending on the types of recorded data.

Color indications depending on current recording status

The recorded data types are represented through the use of different colors. Each color corresponds to a certain recording type.

Event Search

You can search for events by the channel and play them.

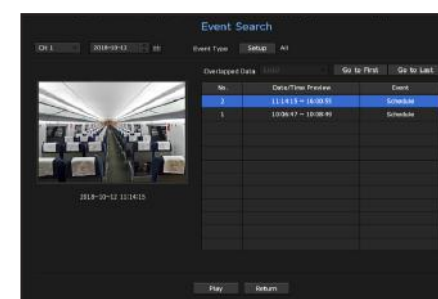

1. Select **<Event Search>** on the **<Search>** menu.
2. Configure the channel and date to search for.
3. Select Event Type. An Event Type pop-up appears when the **<Setup>** button is pressed.
 - Event Type Option: All, Motion, Video Analysis, Auto Tracking, Defocusing, Fog Detection, Audio Detection, Audio Analysis, G-Sensor, Emergency, Sensor, Schedule, Normal Recording
4. Select an event to play from the search list. Then the selected events will be played.

Smart Search

You can select a specific area of the image as an area of interest or exclusion using a virtual line to perform a search of events that have occurred in a specific time period.

- To use Smart Search, set "**Menu > Event > Camera Event > Smart Search**" to <ON> and set the "**Motion Detection**" or "**IVA**" area of the camera to the whole area. However, to perform Smart Search with the Wisenet X series camera or later models, set the virtual area of the camera's "**IVA**" to the whole area. See the "**Camera Event**" page under "**Menu Setup > Setting the Event**" in the Table of Contents.



- In the <Search> menu, select <Smart Search>.
- Configure the channel, search date and time settings.
 - Go to First : Moves to the oldest smart search result.
 - Go to Last : Moves to the most recent smart search result.
 - Event : Displays the type of event generated.
 - Region of Interest : The entire screen is set as a non-detection area and a specific area designated as a detection area. Click and drag on the image or select 4 vertexes to designate a desired detection area.
 - Exclusive Region : The entire screen is set as a detection area and a specific area designated as a non-detection area. Click and drag on the image or select 4 vertexes to designate a desired non-detection area.
 - Virtual Line : Detects a motion towards a marked direction based on the virtual line. At a desired position on the screen, click or drag the start point and end point of the line.
 - Up to 3 areas of interest, areas of exclusion and virtual lines can be set, respectively.
- Click the <Search> button.
 - Search results displayed include a list, timeline and thumbnail.
 - When you double-click a list or thumbnail displayed as search results, the applicable data can be played back.
 - Click the <Next> or <Previous> button to change the date directly within the search results.
- Select data to play and click <Play>.
 - Moves to the playback screen for the data searched.

PLAYBACK

Play

You can play data stored in the HDD and backup a desired portion of the data.



- In the live screen menu, select the <Play> menu or click on <▶> in the launcher menu.
- Select a menu for searches.
 - If this is the first time you try to play, you will start with the data search window. To search for data, see the "**Search & Play > Search**" page in the Table of Contents.
- Select a data item and click <Play> in the Search menu.
 - The selected data is played and the play launcher appears on the screen.
 - If there is an existing data, <Play> will start immediately without performing the search.
- Playback Information : Displays the date and time of the current data in the top corner.
- Backup : Click <⏮> to set the current time to the start time of backup; you can specify a backup area using the mouse (yellow triangle). Click <⏭> again to set the current time to the end time of the backup and the "**Backup Range**" window appears.
 - Type : Supports the SEC format.
 - Device : Select a backup device.
 - Check Capacity : Enables you to check the capacity of the selected storage device.
- If you want to go back to the live screen during plays, then click on <■> of the launcher menu.

Checking menu while playing a video

- Right-click on the play screen.
 - Screen menu appears on the play screen.
- Select a menu to run.
 - For each menu details, see the "**Split Mode Menu**" page under "**Live > Live Screen Menu**" in the Table of Contents.

- Rotate mode only appears in single screen mode. You can rotate the play screen by 90 degrees.

Using the Playback Button

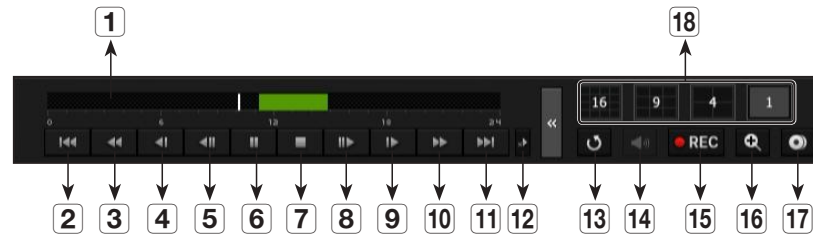

| Name | Description |
|-----------------------------|--|
| 1 Play Timeline | Indicates the current playback point, and can be used to move. |
| 2 Skip Backward | Moves backward by unit time. |
| 3 Fast Backward | Used to rewind a video. (Supports x1, x2, x4, x8, x16, x32, x64, x1, x2 and x4 speed) |
| 4 Slow Backward | Used to rewind the video at a slow speed. (supports x1/2, x1/4, x1/8, x1/2 and x1/4 speed) |
| 5 Step Backward | Moves backward by one frame at a time. |
| 6 Pause | Stops playing the current video temporarily. |
| 7 Stop | Stops playback and moves to the live screen. |
| 8 Step Forward | Moves forward by one frame at a time. |
| 9 Slow Forward | Used to play the video forward at a slow speed. (supports x1/2, x1/4, x1/8, x1/2 and x1/4 speed) |
| 10 Fast Forward | Used to play a video forwards. (Supports x1, x2, x4, x8, x16, x32, x64, x1, x2 speed) |
| 11 Skip Forward | Moves forward by unit time. |
| 12 Playback settings | You can configure the settings for fast play, slow play and skip in detail. ■ Settings may be applied differently depending on the number of channels. |
| 13 Return | Move back to Search Menu before playing back video recording. |
| 14 Audio | Sets Audio ON/OFF. |
| 15 REC | Records all channels in Live mode. |
| 16 ZOOM | This is available in Single mode, which will enlarge the video from a selected channel. To cancel the zooming, simply double-click the enlarged image or select <Close Zoom> in the Live screen menu. |
| 17 Backup | You can back up the video of the channel currently playing back. |
| 18 Mode Switch | Click on a desirable play mode to change the screen segmentation mode. |

starting web viewer

WHAT IS WEB VIEWER?

WebViewer is a software program with which the operator can access a remote NVR (Network Video Recorder) for real-time monitoring, PTZ control (if configured) or search.

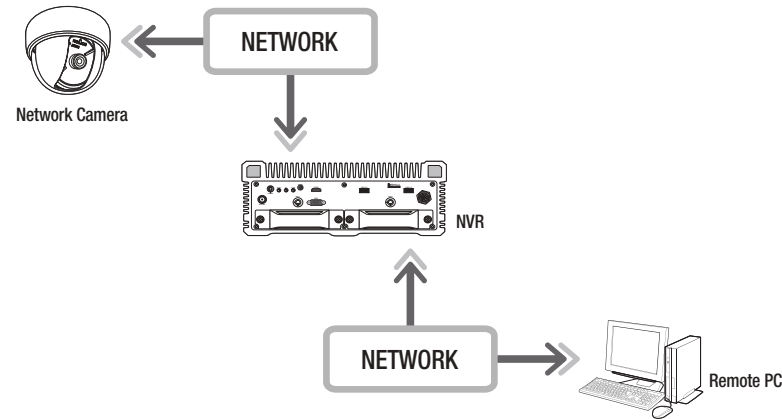

Product Features

- Remote connection using the browser
- PTZ camera control enabled
- Split mode supported
 - 4:3 Mode : 4-split, 9-split, 16-split, 1+5-split, 1+7-split, 1+9-split, 1+12-split, 1+11-split, 2+8-split
 - 16:9 Mode : 2-split vertical, 2-split horizontal, 3-split, 6-split, 12-split, 20-split
- ✎ Depending on the number of channels supported by the product, the number of screen split modes may vary.
- Saving function in JPEG/BMP/PNG image format for printing and storage.
- Record video in AVI format-compatible with popular media players. (The integrated codec is needed)
- To play the video in Windows Media Player, you must download and install the relevant codec from www.windows7codecs.com. (version 4.0.3 or higher)

System Requirements

The following lists the minimum suggested hardware and operating system requirements needed to run the Web Viewer.

| Item | Minimum | Recommended |
|--------------------|---|---------------------------|
| CPU | Intel Core 2 Quad 2.5GHz or higher | Intel i7 (3.5GHz) or more |
| RAM | 3GB or more | 4GB or more |
| HDD | 200GB or more | 500GB or more |
| VGA Memory | 512MB or more | 1GB or more |
| Display Resolution | 1280 x 1024 or higher | |
| OS | - Supported OS : Windows 7, 8.1, 10, Mac OS X 10.9, 10.10, 10.11 - Plug-in free web viewer Supported web browsers : Google Chrome 47, MS Edge 20, Apple Safari 12 and later ※ Mac OS X only - Plug-in Webviewer Supported web browsers : MS Explorer 11, Apple Safari 11 and earlier ※ Mac OS X only | |
| Network | 10/100/1000 Ethernet NIC | |

CONNECTING WEB VIEWER

1. Open your web browser and type the IP address or URL of NVR into the URL address box.



- The default address of the web viewer is "**192.168.2.200**".

2. A user with the admin permissions should provide the admin ID and password. A registered user should provide the user ID and password.



- All settings are applied according to the NVR settings.
- To log in with a different ID, quit your Internet browser and log back in.
- The initial ID and password for webviewer is "**admin**" and "**4321**". When an initial password is entered, while partially resetting to access a web viewer, a pop up window will appear that will guide the user to change the password and when doing a whole reset to access a web viewer, a pop up window will appear that will guide the user to complete the settings for the Install Wizard. Set a new password when a pop up window appears.
- If you change the web port when connecting to the Webviewer, you may fail to access since the applicable port is blocked. In this case, change the port to a different port.
- Please change your password every three months to safely protect personal information and to prevent the damage of the information theft. Please, take note that it's a user's responsibility for the security and any other problems caused by mismanaging a password.

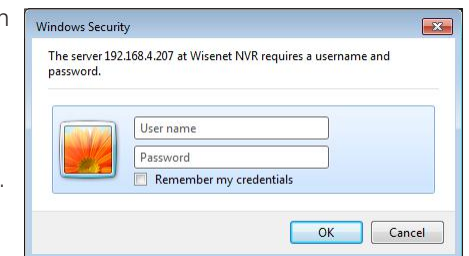

- It allows up to 10 simultaneous access including the Admin and general users.
- Password of the Admin and general users can be changed in <User> menu of the NVR.
- Normal users should have set <Webviewer> under <Restriction on Network Access> to Use before connecting to the Web Viewer. See the "Setting Permissions" page under "Menu Setup > User" in the Table of Contents.
- All settings are applied by the NVR's settings.

3. The plugin installation confirmation pop-up window will appear.

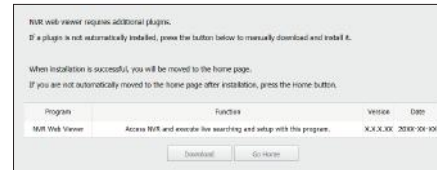

4. When a program installation wizard window appears, press the [Install] button to install the program.

- The version of the program installed may vary depending on the update version.

5. When program installation is complete, click on the [Finish] button.

6. After completing installation and successfully logging in, the main live viewer screen appears.



To access the plugin web viewer

Set auto execution of plugin (npNVRViewer) in the browser menu that you first access and refresh the screen after activating the plugin or selecting plugin reliability.

- Each time the browser is upgraded in the future, the plugin activation method can be changed. Plug in setting menu can be referred to in the browser manual.

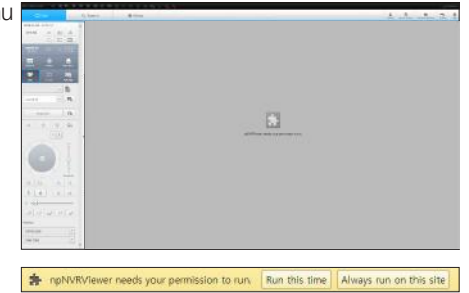

- On a browser in the latest version that does not support plug-ins, please refer to the descriptions about the plug-in free web viewer stated below.

To access the plugin free web viewer

Internet browsers that do not use plug-ins will automatically connect to the plug-in free web viewer. (e.g.: Chrome, Edge Browser)

- As the plug-in free webviewer has lower performance than the plug-in webviewer, it has a limit on the monitoring of high quality profiles. To monitor high quality profiles, use either a plug-in webviewer or network Viewer.

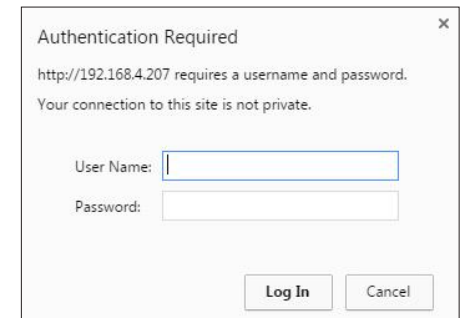

- If you log in to the web viewer without registering any camera to the product, the Register camera window will appear along with the product installation wizard. If the number of detected cameras is smaller than the number of channels supported by NVR, then all of them are automatically registered and the registered camera information (fps and possible recording days) will be displayed. If it is greater than the number of channels supported by NVR, then you need to select a specific camera and register it. See the "Live > Install Wizard" page in the Table of Contents. However, if your product supports PoE, then no camera is automatically registered—only the list of detected cameras will be displayed.

LIVE VIEWER

You can check the video from camera registered in the NVR connected from a remote PC. Also, you can adjust the camera and check the network transfer status.

Screen layout of the plugin free web viewer

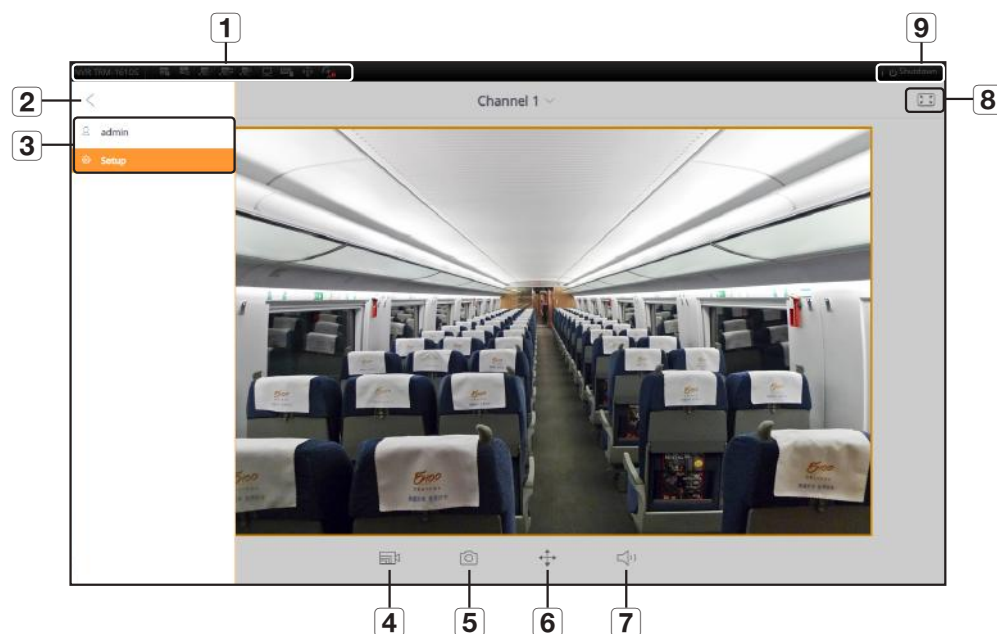

| Menu | Description |
|--------------------------------|---|
| 1 System Status Display | Displays icons that indicate the screen state of system status. <ul style="list-style-type: none"> For more detailed description of each item, see the "Live Viewer > Live Screen Configuration" page in the Table of Contents. |
| 2 View Menu | Enables or disables View Menu. |
| 3 Select Menu | Displays the user login ID and moves to the setup page. <ul style="list-style-type: none"> It uses the same setup method as the existing web viewer. See the "Setup Viewer" page in the Table of Contents. |
| 4 | Changes the camera profile. |
| 5 | Captures the current video and saves it in a designated path. |

| Menu | Description |
|-------------------|---|
| 6 | Supports the PTZ Digital Zoom function. |
| 7 | Turns the sound ON/OFF. |
| 8 | Changes the aspect ratio. |
| 9 Shutdown | Turns off the power of the NVR system. |

- Plug-in Free Webviewer only supports a single split live screen. However, output of only up to 720p resolution is available. Resolution exceeding 720p will not be displayed. (Exception - H.265 codec is not output if the resolution and frame rate exceed 720P 26fps.)
 - You can change the live screen by selecting <Channel 1>.
 - If "Out of Web Resources" pop-up message is prompted, adjust the monitor resolution.

Screen layout of the plugin web viewer

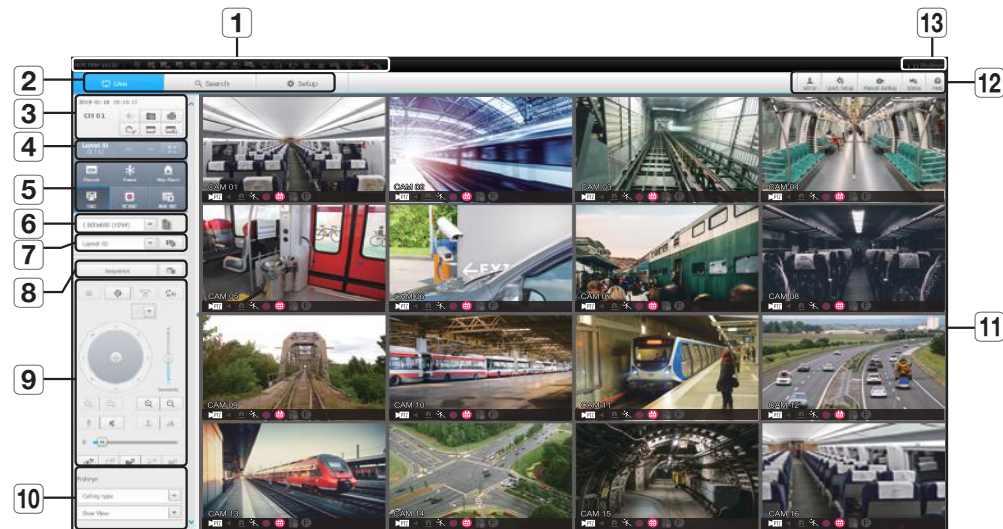

| Menu | Description | |
|----------------------------------|--|--|
| 1 System Status Indicator | Displays icons to display the screen or system status. | |
| 2 Menu Selection | Switches into corresponding menu screen by clicking each menu. | |
| 3 | Date/channel | Shows the access date/time and the selected channel. |
| | Sound | Sets the sound connected to each channel to either ON/OFF. |
| | Capture | Saves current video for the selected channel in the path designated by the user. |
| | Print | Prints current video image for the selected channel through designated printer. |
| | Rotate Video | Rotates the screen of a selected channel by 90 degrees. |
| | Keep ch. scr ratio | Changes screen ratio of the selected channel. |
| | Keep full scr ratio | Changes screen ratio for all channels. |
| 4 | Channel change | Switches to the previous/next channel group. |
| | Full screen | Switch from the full screen to the split screen. Press the [ESC] key on the keyboard to exit full screen mode. ▪ Safari for Mac does not support full screen mode. |

| Menu | Description | |
|-----------|---------------------|--|
| 5 | Channel information | Shows the channel information selected. ▪ If the user's PC monitor does not support 60Hz at a specific high resolution, or the HDMI cable does not support HDMI 2.0, 60fps or higher will not be output from the channel information. |
| | Pause | Temporarily stops the videos in all the channels or deactivates the Pause function in suspending status. |
| | Stop Alarm | Deactivates an alarm when it occurs. |
| | OSD | Check the OSD item to display the OSD screen information in the web viewer window. |
| | PC recording | Saves the real-time video, in AVI format, from the selected channel in a designated folder on the PC. |
| 6 | NVR recording | Start and stop NVR recording. |
| | Select Profile | Sets a desired profile for each channel. |
| 7 | Layout setting | Set the layout. |
| 8 | Switching | Set the sequence. |
| 9 | PTZ | Controls connect PTZ camera(s). |
| 10 | Fisheye | Runs the fisheye settings for the selected channel. (Configures the mounting mode and the view mode to correct the screen distortion.) |
| 11 | Display Pane | Displays the video of camera connected to NVR. |
| | ID | Display the ID of user connected. |
| | Quick setup | Simple camera registration and recording settings. |
| | Manual backup | Manually backup the video of the camera connected. |
| | Status | Shows the camera live and recording status. |
| | Help | Move to the help window. |
| | Shutdown | Turn off the NVR system. |

LIVE SCREEN CONFIGURATION

System Status

You can check the status or operation of the NVR with the icons on the live screen.

- On a plug-in free web viewer, some of the status information icons are not displayed.



| Item | Description |
|------|--|
| | It is displayed when there is a problem with the fan. |
| | It is displayed when there is an issue with the recording conditions. |
| | Displayed if the HDD is full and the NVR has an insufficient space to record. |
| | Displayed if no HDD is installed or the existing HDD should be replaced. |
| | Displayed if the HDD needs a technical examination. |
| | It is displayed when there is a malfunctioning HDD in the RAID. <ul style="list-style-type: none"> There are one or two HDD malfunctions but you can still read or write to it. Only provided for products that support RAID. (See page 4 of the Product Specification Manual) |
| | It is displayed when recovering an RAID Error. <ul style="list-style-type: none"> Only provided for products that support RAID. (See page 4 of the Product Specification Manual) |
| | It is displayed when you cannot write RAID due to a malfunction of HDD. <ul style="list-style-type: none"> Only provided for products that support RAID. (See page 4 of the Product Specification Manual) |
| | Appears when input data rate per channel exceeds the specified data rate limit. |

| Item | Description |
|------|--|
| | It is displayed when the network is overloaded. It is displayed when the network is overloaded. <ul style="list-style-type: none"> It occurs when the max receiving performance is exceeded, causing an overload to the CPU. It will disappear if you modify the camera setting or delete a camera to reduce the level of performance overload. |
| | It is displayed when there is firmware to update the server. It is displayed when there is firmware to update the server. |
| | Displayed when the battery that enables time information to be saved in the NVR equipment is empty. |
| | If you press the screen stop button, it is displayed. |
| | It is displayed when all the channels are switched at the set time interval. |
| | Appears when emergency recording is in progress. |
| | Shows the vehicle shake state. |
| | Shows GPS reception/no reception. |
| | Displays the Wi-Fi connection status when <Wi-Fi Enable> is set. |

Using the setting icons



- : Display the ID of user connected.
- : You can register a network camera for each channel and easily set the resolution and the number of shots in case of event occurrence or manual recording.
 - For more information about how to register a camera, see the "To register a camera" page under "Menu Setup > Setting the Device" in the Table of Contents.

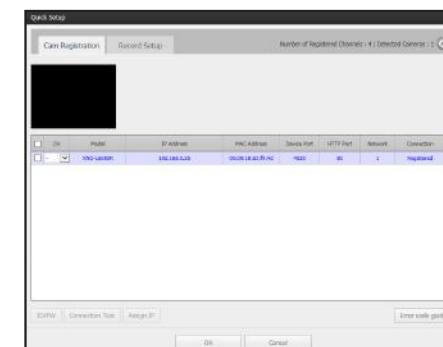

-  : You can manually enter the desired backup channel and time/date to backup the recorded video.

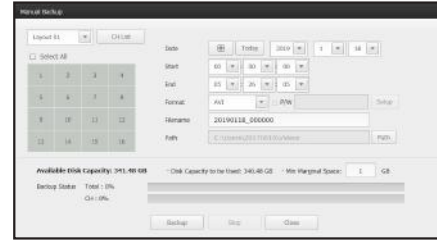

-  : You can check the recording status and the status of camera connected.
 - Live : Select <Live> to check the status of camera connected to each channel and the transmission information.
 - Recording : Select <Record> to check the following for each channel : profile, recording type, inputs / recording transmission rate, settings / inputs / amount of recorded data.
 - PoE: If you select <PoE>, you can check the amount of PoE consumption connected to each channel. Only available for products that support PoE.

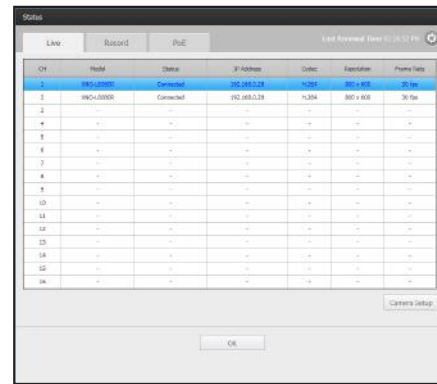

-  : You will be immediately directed to the homepage of Hanwha Techwin.

To capture a screen

1. Click  button. When a pop-up window appears, select the saving path for captured image.
2. Select the path and name the file. And then click the <OK> button.
3. Save current camera's video image as .bmp, .jpg or .png file.

- ! If the viewer is running without the administrator's permission in Windows 7, you may not save the captured image as .bmp, .jpg or .png file.

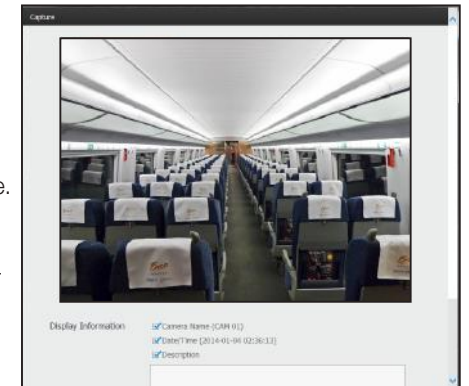

To print a screen

1. Click  button.
2. Print current camera's video image with the printer connected to the PC operating the Web Viewer.

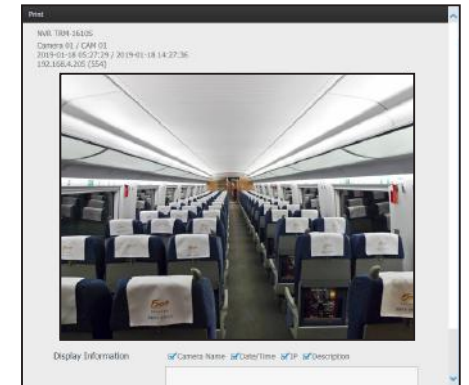

Selecting a profile

You can select a profile for each channel.

1. Multi-split screen is connected to profile #1 by default.
2. Single split screen is connected to profile #2 by default.
3. The user can select a profile to change it.
 - Due to the PC performance or network bandwidth issues, the connection or video display may fail.

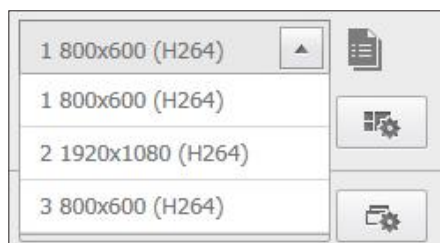

Setting the layout

If you don't add or save it in the layout after registering a camera, the live screen will not be displayed.

Click on the  button to launch the layout setting screen.

If you want to add a layout

Click on .

Set the layout name to add and click on the **<OK>** button to add it.

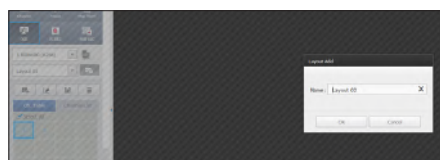

If you want to change the layout name

Select the layout name to change and click on .

After changing the name, click on the outside of the layout window to change the name.

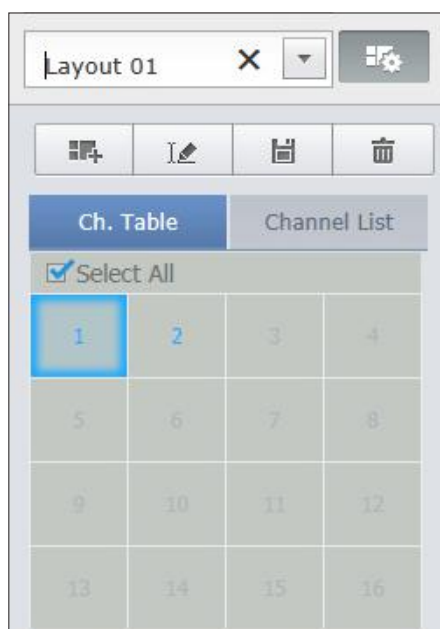

If you want to save the layout

Click on .

The changed layout will be saved.

-  ▪ The layout for each user is saved separately.

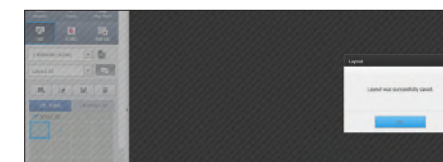

If you want to delete the layout

After selecting the layout to delete, click on .

The selected layout will be deleted.

-  ▪ Unless you press the Save or Delete button, changes will not be saved.

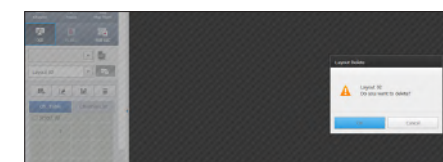

Changing Split Mode

When clicking the Split Mode selection button, the screen is changed into the selected split mode.



Setting screen switching

If you don't register the layout, the screen switching function will not operate.

You can view the layouts one by one.

Click on the <  > button to launch the switching setting window.

1. Select the layouts to be shown in turn by pressing <  >.
2. Enter the screen switching time.

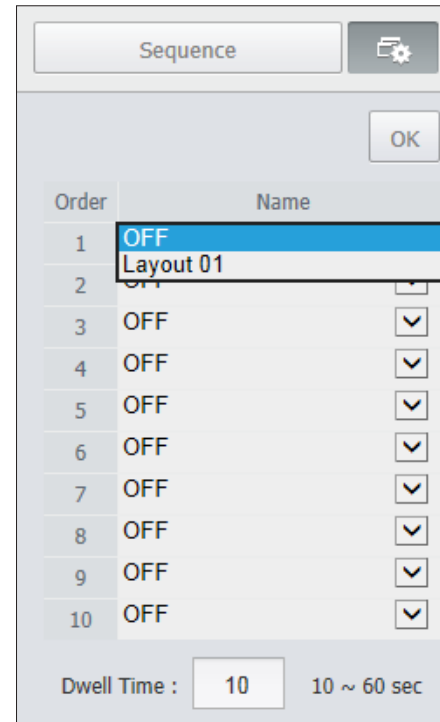

3. Click on the <OK> button to save the designated sequence.

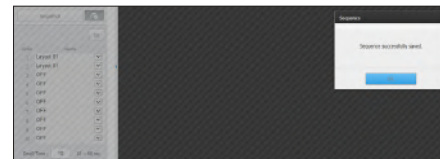

To perform switching

Click on the <Sequence> button to activate the switching mode and run a sequence.

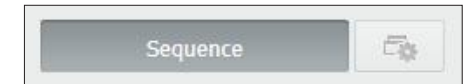

Auto Sequence

You can monitor the split mode of your own choice by switching one after another at a certain interval.

- For segmented screen switching, set <Sequence switching time> on the "Monitor" page under "Menu Setup > Setting the Device" in the Table of Contents to automatically switch to the next sequence according to the preset time.
- When switching to another channel, the video may be slightly delayed depending on network status.
- If you perform automatic switching of a single screen, the layout setting menu will be deactivated during operation.

Example) TRM-1610S

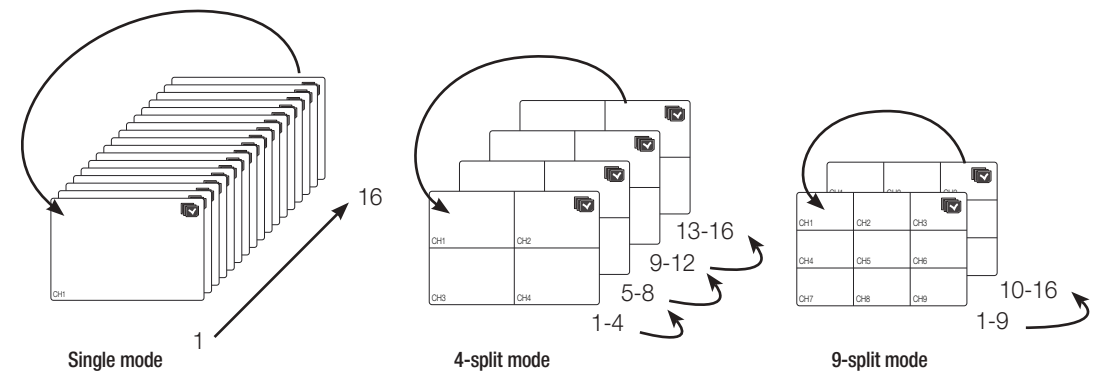

CONTROLLING A CONNECTED NETWORK CAMERA

Controlling PTZ

If PTZ camera is connected, the <PTZ> icon appears on screen. When selecting corresponding camera channel, the PTZ tab is provided to allow you to control the PTZ.

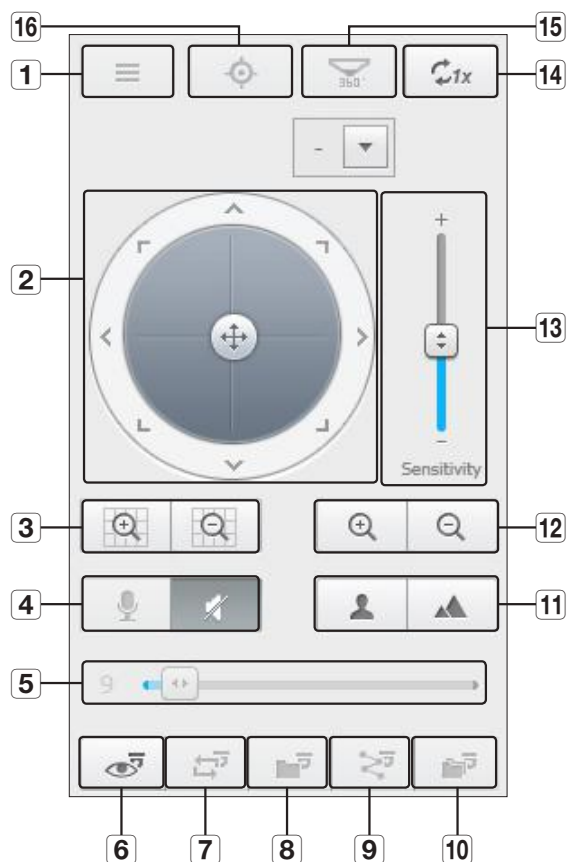

| Item | Description |
|------|---|
| 1 | Camera menu Displays the camera settings menu. |
| 2 | Direction Adjustment Use this to adjust the direction of the camera or click the crosshair in the center to use it as an OK button. |
| 3 | Digital zoom Adjust digital zooming to make an image larger or smaller. |
| 4 | Sound You can set the camera audio torque and mute. |
| 5 | Volume control Change the PC volume between 0 and 100. |

| Item | Description |
|------|---|
| 6 | Preset Sets the preset position for camera framing and moves to designated preset position when selecting a desired preset. |
| 7 | Swing Moves between the preset start point and end point. |
| 8 | Group Moves in the path specified by combining the preset. |
| 9 | Trace Moves camera's framing in the predefined path. |
| 10 | Tour Moves in the path specified by combining multiple groups. |
| 11 | Focus Adjusts the focus of the camera. |
| 12 | Zoom Zooms in/out the image by controlling camera's zoom. |
| 13 | Sensitivity Adjust the sensitivity of your camera operation. |
| 14 | Digital Zoom Off Returns to the original size from the zoomed state. |
| 15 | Fisheye D-PTZ Provides the digital PTZ function for the distortion corrected screen. |
| 16 | Simple focus Automatically adjusts the camera focus. |

To activate digital zoom

1. Press the < [Zoom In] > button and the screen will be zoomed in by 50% per click.
2. Press the < [Zoom Out] > button and the screen will be zoomed out by 50% per click.
 - You can zoom in or out by 10% with the mouse wheel.
3. Click the < [Digital Zoom Off] > button and the screen returns to 100% size.

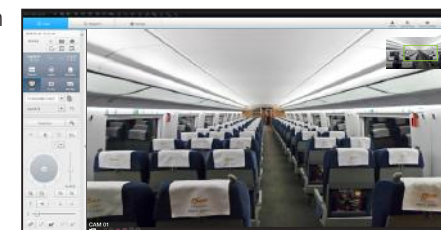

- Digital zoom function is only available in the single model.



To use the Digital PTZ (D-PTZ) function

1. Register a camera that supports the D-PTZ profile.
 - In cameras that support the D-PTZ profile, you can use the D-PTZ function.
2. Both cameras that support general PTZ and cameras that support D-PTZ can control the live image using some of the <PTZ control> function menus.
 - For more information about the supported functions, please refer to the camera manual.

To use the digital PTZ function on a distortion corrected screen

1. On the dewarped screen, click the icon.
2. Place the cursor on the screen and drag it to control.

To set a preset

1. Click <  > button to display "Preset" window.
2. Click on <  > to select the preset order.
3. Enter the name of preset.
4. Use direction keys to adjust the direction which camera aims at.
5. Click the <  > button.

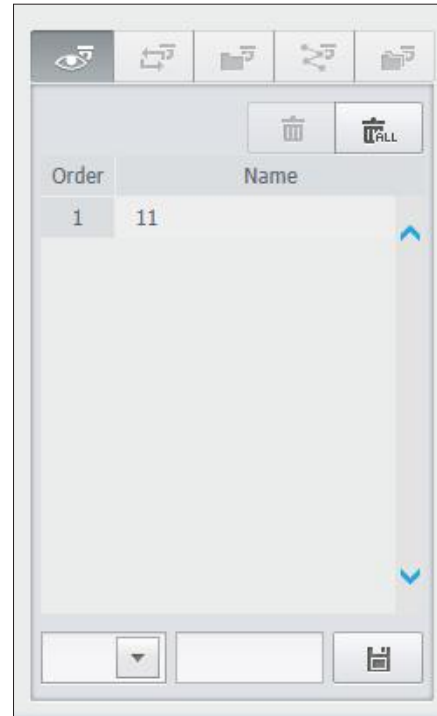

To activate the preset

1. Click <  > button to display "Preset" window.
2. Select a desired preset to activate from the list.
The camera's framing moves to the preset position.

To activate Swing(Auto-pan), Group(Scan), Trace(Pattern) and Tour

You can activate listed functions in the same manner as using a preset. For more information, refer to corresponding user manual of applicable camera.

-  Only selective functions of the camera can be supported, depending on camera.

SEARCH VIEWER

You can search and play the video record saved in NVR by accessing NVR remotely.

Search Viewer Screen

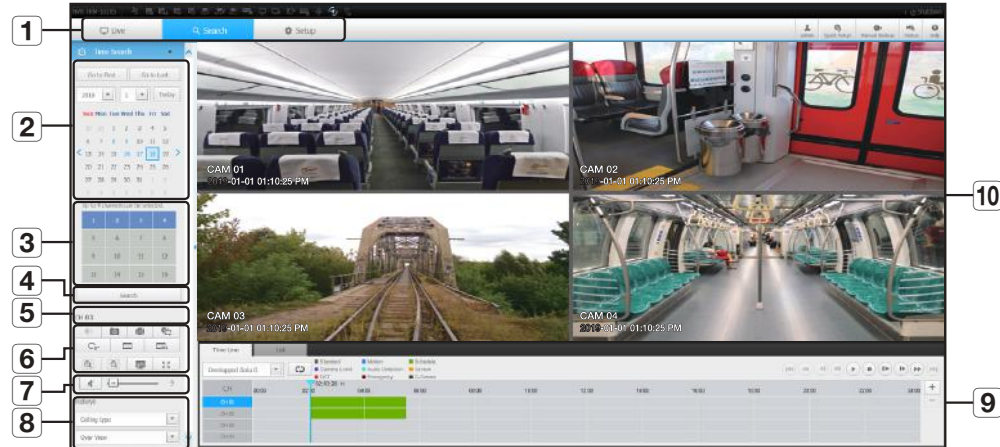

| Item | Description |
|------|---|
| 1 | Menu Selection Switches to the corresponding menu screen by clicking each menu. |
| 2 | Calendar Displays the video-recorded date in blue and today in red. Click the date in blue color to display the recorded video information in timeline. |
| 3 | Channel selection Displays the search channels. |
| 4 | Search Search for the user designated channel for the selected date. |
| 5 | Channel displays Display the selected channel number. |

| Item | Description |
|------|---|
| | Sound Sets the sound connected to each channel to either ON/OFF. |
| | Capture Saves current video for selected channel in the designated path. |
| | Print Prints current video image for selected channel through the assigned printer. |
| | Section backup Backup the video for the selected section. |
| | Rotate Video Rotates the screen of a selected channel by 90 degrees. |
| 6 | Keep ch. scr ratio Changes screen ratio of the selected channel. |
| | Keep full scr ratio Changes screen ratio for all channels. |
| | Magnify/Shrink Magnify or shrink the current video for the selected channel. |
| | OSD Displays the channel information. |
| | Full screen Show the four way split screen in the full screen. |
| 7 | Sound control Adjust the audio for the video searched. |
| 8 | Fisheye Runs the fisheye settings for the selected channel. (Configures the mounting mode and the view mode to correct the screen distortion.) |
| 9 | Recording Color Displays the corresponding color depending on recorded data type if you place your mouse cursor on that area. |
| 10 | Display Pane Plays corresponding data on the screen if you select a search result. |

Time Search

You can search recorded data by setting date and time.

To search by date

You can select the search date by using calendar.

1. Click on < < > > to select the year/month for your search.
If a date has data associated with it, it is displayed in blue. The current date is displayed as a blue box.
2. Click the date to search in calendar.
The first image of searched video data on the date is displayed on screen and the data is displayed in the timeline.
3. To search video data on today, click <Today>.
Today's date is selected.

Color indications depending on current recording status

Displays the corresponding color according to the recorded data type.



- If 2 or more kinds of recording type are mixed for the same timeline, only the recording type with higher priority is displayed. (Priority: Emergency > G-Sensor > DST > Audio Detection > Camera Event > Sensor > Schedule > Motion > Standard)

To adjust timeline

If searched data are overlapping, you can select a desired data, move its playback time point, and zoom in/out the timeline.



- Select the number of data to search if data is overlapping. It appears only when data are overlapped and assigns <0> to the most recent data.
- Click your desired time point to play on the timeline. The playback start point is moved.
- Click <+> / <-> to zoom in/out the zoom factor to display time.
- When magnified, if you want to view the pre/post timeline, click on the timeline and drag it in the direction you want to move it.

If you want to check the recording list

The results for each recording section will be displayed.



To back up the search results

You can back up the search results in the list.

- Click the [] button.
- From the search results, select the check box of the item you wish to back up.
 - Format : Select the format of the file to back up.
 - AVI : Codec information provided from the NVR is saved together and can be played in a separate viewer (Windows Media Player, etc.) on the PC.
 - SEC : Proprietary file format, which can be played on the PC immediately as it is saved with a dedicated viewer.
 - If you select the SEC format, you can select whether or not to use "Password Setup".
 - Path : displays the location of the folder in which the section backup file is to be saved.
- After completing the backup settings, click the <Backup> button.
 - If you press the <Stop> button during the backup process, the backup will be suspended.

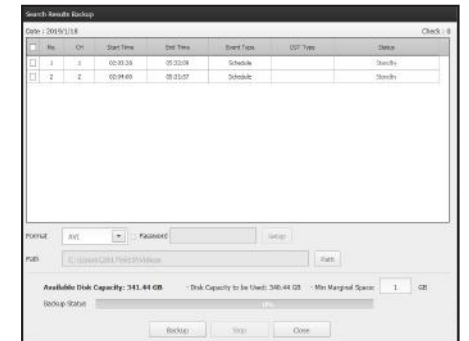

To run the section backup function

You can select and back up a desired section in the timeline or list of video(s) being played.

- Click the [] button.
- On the timeline of a video being played, select the start point and the end point of the section to back up. Section backup settings screen will open.
 - Channel : Displays the channel for the section backup.
 - Backup section : Displays the <Start time> and the <End time> of a section to back up.
 - Format : Selects the format of a section to back up.
 - AVI : Codec information provided from the NVR is saved together and can be played on a separate viewer (Windows Media Player, etc.) on the PC.
 - SEC : Proprietary file format, which can be played on the PC immediately as it is saved with a dedicated viewer.
 - If you select the SEC format, you can select whether or not to use "Password Setup".
 - File name : Sets the name of a section backup file.
 - Path : displays the location of the folder in which the section backup file is to be saved.
- After completing the section backup settings, click the <Backup> button.
 - If you press the <Stop> button during the section backup process, the backup will be suspended.

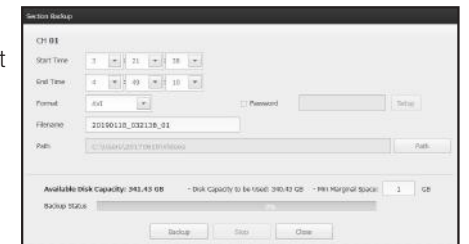

Names and Functions of Play Buttons

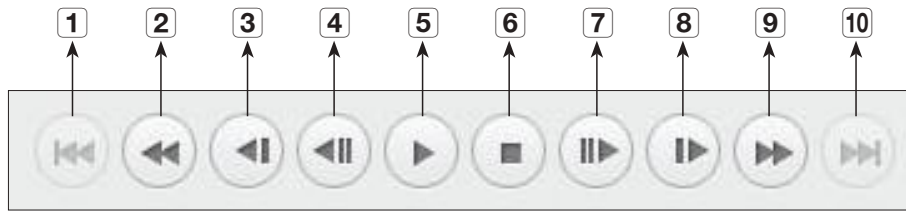

| Item | Description |
|--|---|
| 1 Back | Returns to the previous event. |
| 2 Backward X Times Playback | Used to rewind a video. (Supports x1, x2, x4, x8, x16, x32, x64, x1, x2 and x4 speed) |
| 3 Deceleration in the reverse direction | Used to rewind the video at a slow speed. (supports x1/2, x1/4, x1/8, x1/2 and x1/4 speed) |
| 4 Previous Frame | Move to the frame in reverse direction. |
| 5 Play/Freeze | Video is played and paused. |
| 6 Stop | Terminates the video play. |
| 7 Next Frame | Move to the frame in the forward direction. |
| 8 Deceleration in the forward direction | Used to play the video forward at a slow speed. (supports x1/2, x1/4, x1/8, x1/2 and x1/4 speed) |
| 9 Forward X Times Playback | Used to play a video forwards. (Supports x1, x2, x4, x8, x16, x32, x64, x1, x2 speed) |
| 10 Forward | Proceeds to the next event. |

SETUP VIEWER

You can configure the NVR settings remotely on the network.

To configure the NVR settings, click <Setup>.

Settings Screen

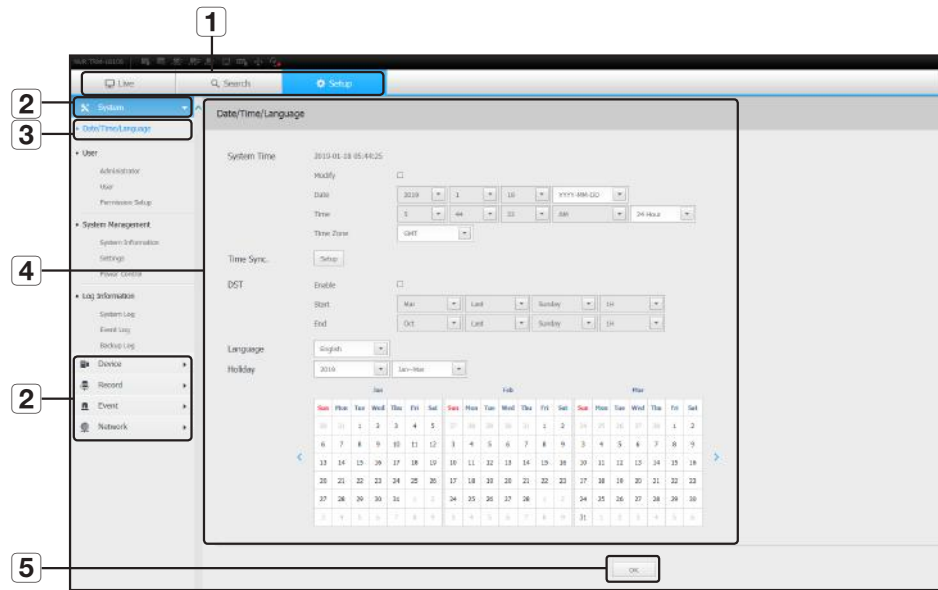

| Item | Description |
|------|---|
| 1 | Menu Selection Click each menu to switch into corresponding menu screen. |
| 2 | Parent Menu Configure the settings or select a parent item to change the existing settings. |
| 3 | Sub-Menu Among the sub-menus of selected parent menu, select a desired item to set. |
| 4 | Detailed Menu Click desired item's input field to change and enter a desired value. |
| 5 | OK Apply the modified settings. |

System

You can configure the various settings of the NVR system.

Date/Time/Language

See the "Setting the Date/Time/Language" page under "Menu Setup > System Setup" in the Table of Contents.

Date/Time

Set the date and time.

Time Synchronization Setup

Set the time synchronization.

DST (Daylight Saving Time)

During the summer, Daylight Saving Time (DST) advances clocks one hour forwards from the standard local time zone.

Language

Select a preferred language for the NVR.

Holiday

A user can select specific dates as holidays according to their own preferences.

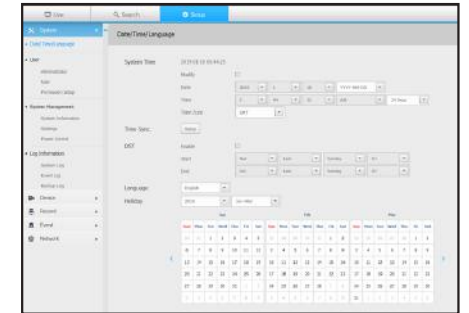

User

See the "User" page under "Menu Setup > System Setup" in the Table of Contents.

Administrator

You can change the admin ID or the password.

- ID allows alphanumeric characters only.
- If the admin ID is not used for access, you cannot change the ID.
- If the ID being used is changed, you will be automatically logged out.

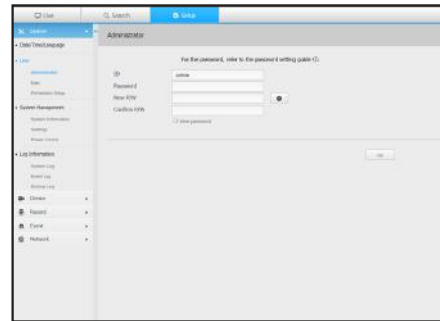

User

You can add, change or remove a user or users.

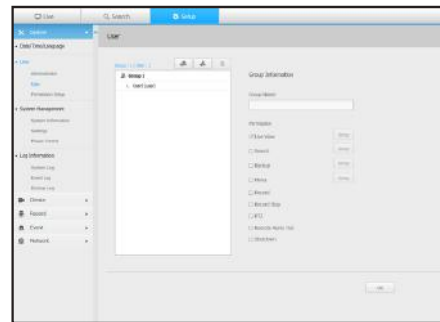

Permission Setup

You can set the user permission.

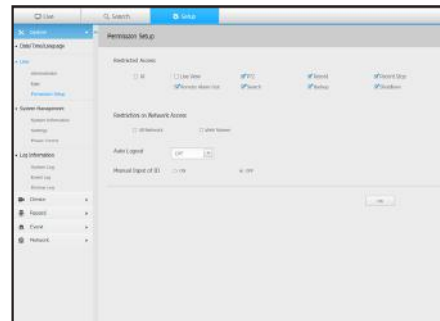

System Management

See the "System Management" page under "Menu Setup > System Setup" in the Table of Contents.

System Information

You can see information of the current system.

Check the model name, software version, micom version, MAC address and RAID version.

You can search for a file from the storage device connected to the PC to perform an upgrade.

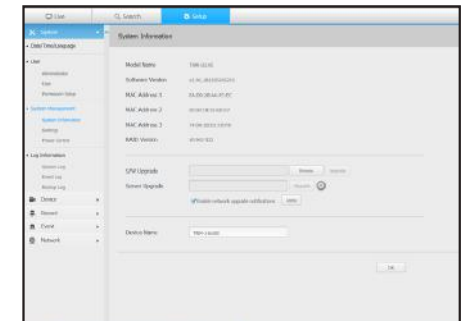

Settings

Using a storage device, you can apply the current configuration of NVR to another NVR.

Press the Initialize button to return the network settings to their factory default state. Items in the <Not Included> category are excluded from the initialization.

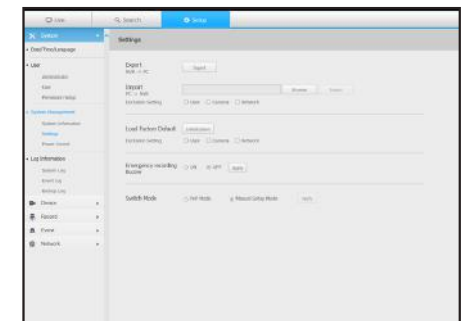

Power Control

You can set the use of power shutdown, delayed boot, shutdown time, and shutdown voltage.

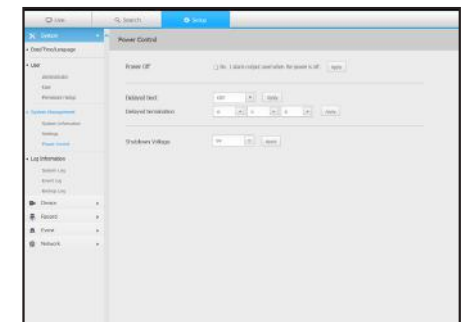

Log information

System log

Data recorded in the system log displays various system-related logs/date/time such as system starts, system ending and menu setting changes.

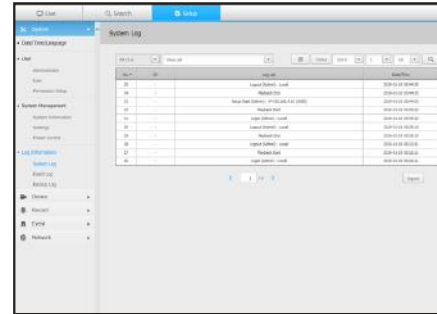

Event log

The event log lists recorded events, such as sensor events, camera events, or image losses.

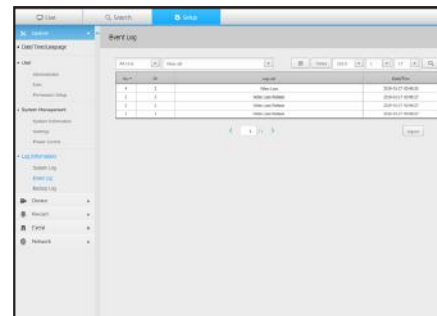

Backup log

You can inquire about a user who performed a backup, execution time, details (backup time, channel, backup device, backup file type).

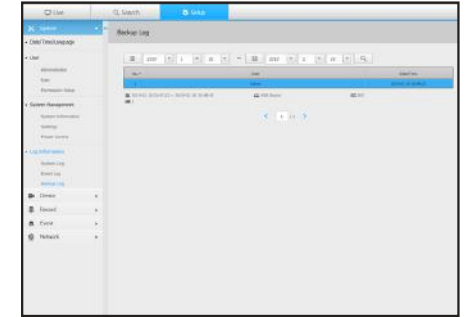

Device

You can check a list of devices that are connected to the NVR and configure the necessary settings. Click **<Device>** in the menu screen. For more detailed setup, see the "**Menu Setup > Setting the Device**" page in the Table of Contents.

Camera

Cam Registration

You can add a network camera(s).

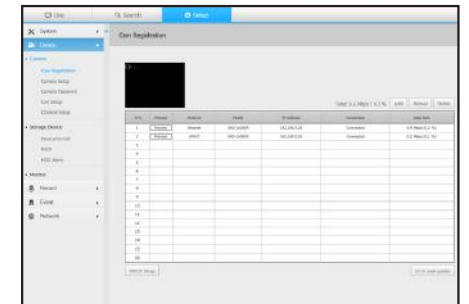

setup viewer

Camera Setup

You can change the settings of a connected network camera.

- When you click the **[Camera website]** button, a new camera web browser window is opened.
 - This is not supported if the camera is connected to the RTSP protocol.
 - This is not supported if the camera is connected to DDNS, URL, or MAC Address.
 - It supports the version specified below or later for each Q/P/X series camera.
(QND-7010R series: 1.04, QND-7080R series: 1.02, QND-6010R series: 1.02, QND-6070R series: 1.01, P series: 1.01)
 - It supports only when the camera is connected to IPv4 and is not set to HTTPS.
 - When you are connecting to the camera web page on a closed network, a camera that does not support the universal web will not be able to output an image.
 - When trying to connect, if the plugin does not get installed, try again after setting the compatibility view from the web page of the NVR web viewer.
 - The cam proxy port's default settings are automatically set in sequence as many as the number of channels supported by NVR. If you want to change the proxy port, then select the port setup menu.
 - 4 channels (10001-10004), 8 channels (10001-10008), 16 channels (10001-10016)

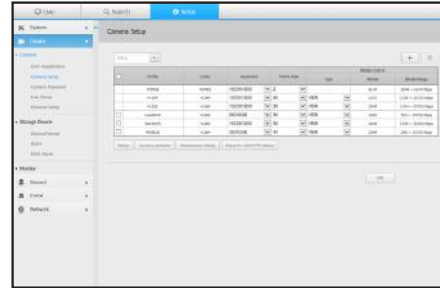

Example) Defaults of cam proxy ports for each product

- TRM-1610S, TRM-1610M (16 channels): 10001-10016
- TRM-810S, TRM-810M (8 channels): 10001-10008
- TRM-410S (4 channels): 10001-10004
 - When connecting outside the closed network as shown in the figure, the port forwarding setting of the camera proxy port is required for the router.

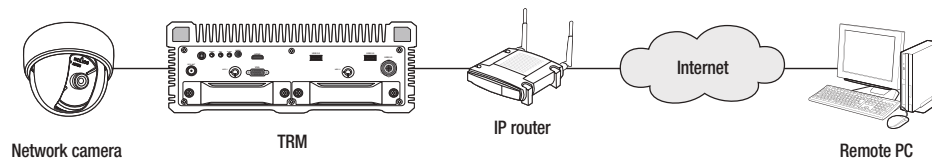

- If there are multiple NVRs within the closed network, each cam proxy port should be set using a different port.
- If DDNS and Quick Connect are enabled, port forwarding will be automatically set.
- Internet Explorer, Chrome, and Safari browsers are supported.

Camera Password

You can change the passwords of all registered cameras at once.

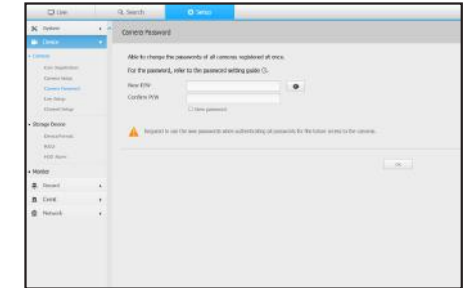

Live Setup

You can change the live transfer settings of the network camera.

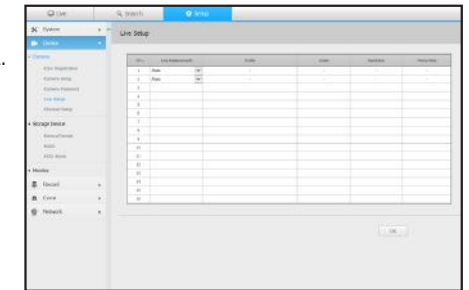

Channel Setup

You can configure the video settings for each channel.

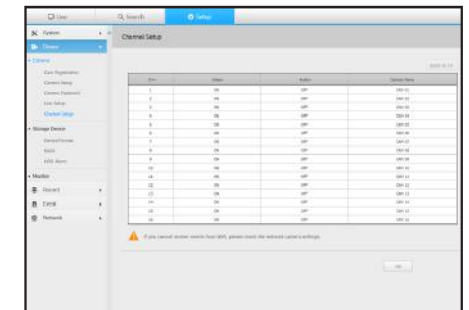

Storage Device

You can check and change the settings related to the data storage device.

Device/format

You can check a storage device, amount of use, type of use and status of storage device.

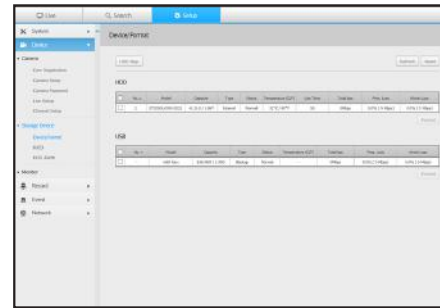

RAID

This function is only available for products that support RAID. For products that support RAID, see **“NVR products supporting each feature”**. (Page 4)

If you set the RAID mode, then even if the system HDD is damaged, you can safely recover data.

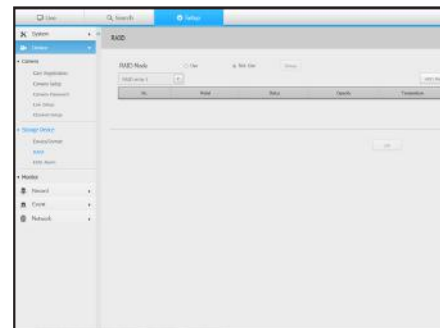

HDD Alarm

You can set the alarm output port and the duration in case an error occurs.

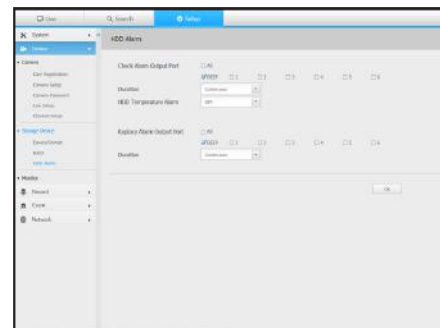

Monitor

Monitor

You can configure the monitoring screen settings and set the output system.

- ✎ If the screen does not work properly, see **“Troubleshooting (FAQ)”** in the Appendix.
- The Monitor Setup settings control the monitor connected to the NVR.

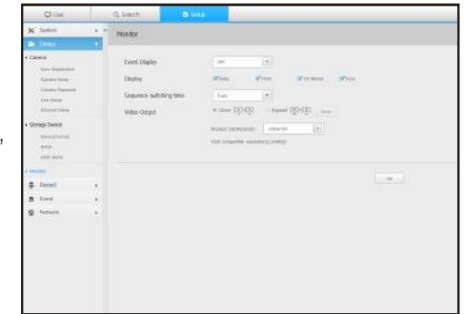

Record

For more detailed setup, see the **“Menu Setup > Setting the Recording”** page in the Table of Contents.

Recording Schedule

If you set a recording schedule for a specific date and time, the recording will start at that specific time.

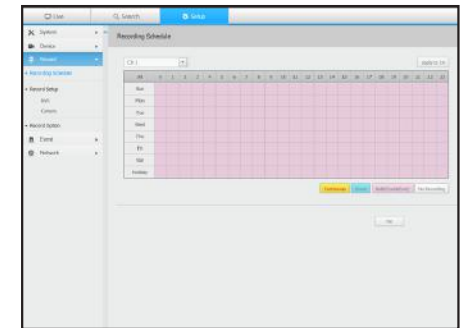

Record Setup

NVR

Select a type of the normal/event recording frame rate for each channel.

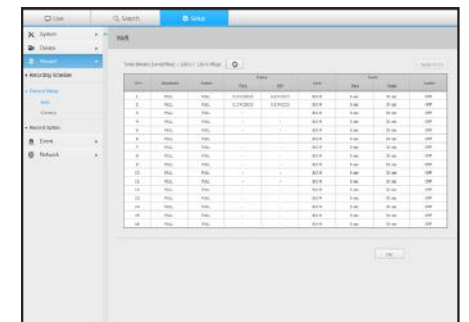

setup viewer

Camera

You can set the recording profile for a network camera.

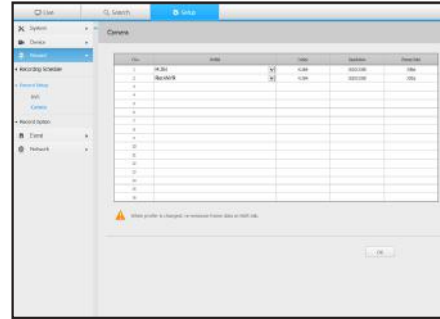

Record Option

You can set the Disk End Mode.

- You can set the recording duration separately for each channel.

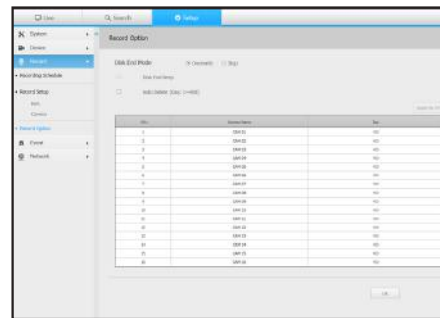

Event

For more detailed setup, see the "**Menu Setup > Setting the Event**" page in the Table of Contents.

Sensor Detection

NVR / Camera

You can set the sensor operation mode and the synchronized camera as well as the alarm output type and the duration.

- If the connected network camera that has configured the alarm in/out settings triggers an alarm, NVR will perform the alarm out.

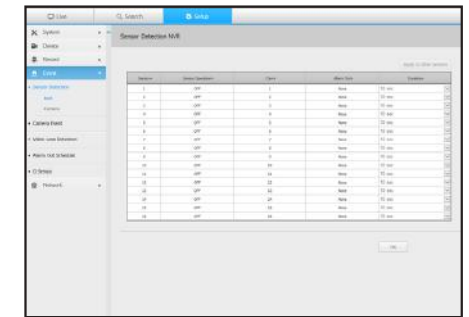

Camera Event

You can set NVR and camera event mode, alarm output type and alarm time.

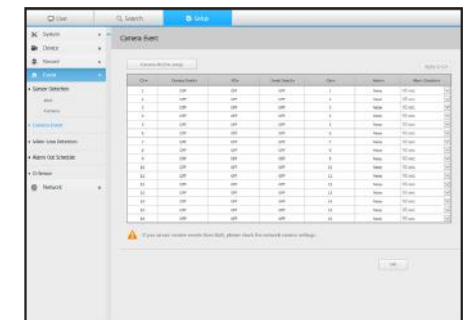

Video Loss Detection

You can set to trigger the alarm if a video loss occurs.

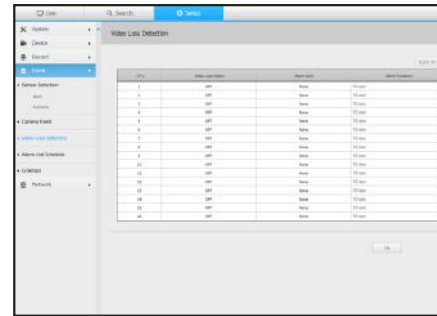

Alarm Out Schedule

You can schedule the alarm output according to the day of the week and the time. The default setting is Event Sync, which activates the alarm only if an event occurs.

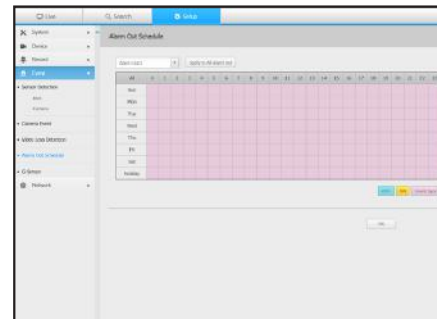

G-Sensor

You can set G sensor events and alarms to operate depending on vehicle movement.

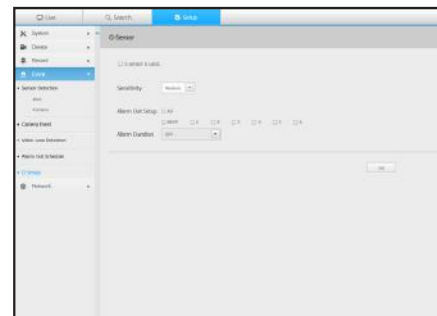

Network

For more detailed setup, see the "Menu Setup > Network Configuration" page in the Table of Contents.

Interface

A remote user can access the NVR via the network to check the current mode and the IP address.

Network

Specify the network connection path.

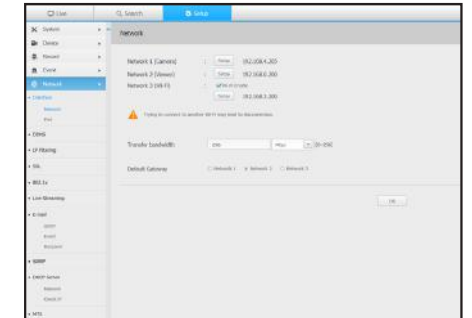

Port

You can configure the protocol related settings.

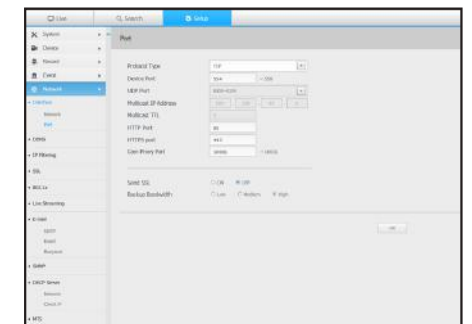

setup viewer

DDNS

You can set DDNS.

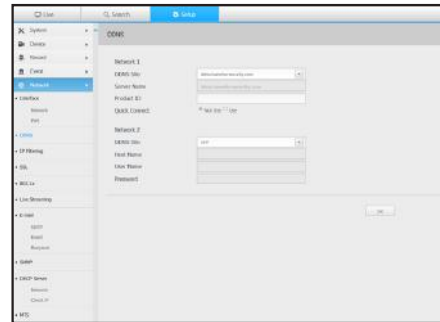

802.1x

When connecting to a network, you can select whether to use the 802.1x protocol and install corresponding certificate.

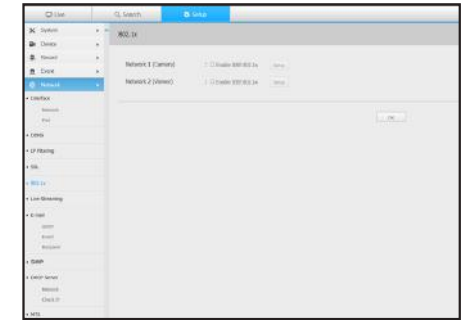

IP Filtering

You can prepare the list of IP address to allow or block accesses to a specific IP address.

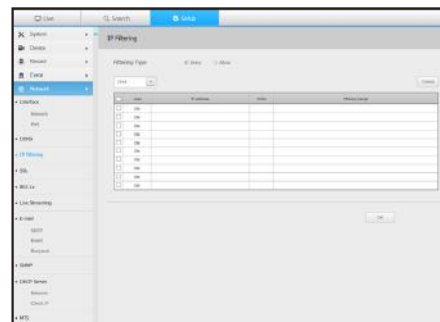

Live Streaming

You can set the video profile transmitted to the network and the expansion monitor.

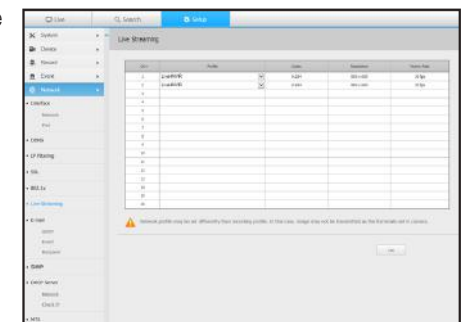

SSL

You can select a security connection system or install public certificates.



- While using HTTPS, if you want to switch to HTTP, then abnormal operation can take place as the browser contains the setting values. You need to change the URL to HTTP and reconnect or initialize the cookie setting of the browser.

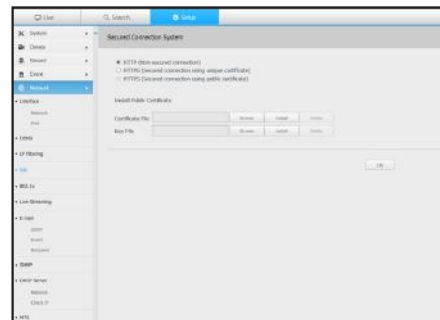

E-mail

You can specify the SMTP server that sends a mail if an event occurs and set the recipient group and users.

SMTP

You can set the server that sends mails and specify if you use the authentication process.

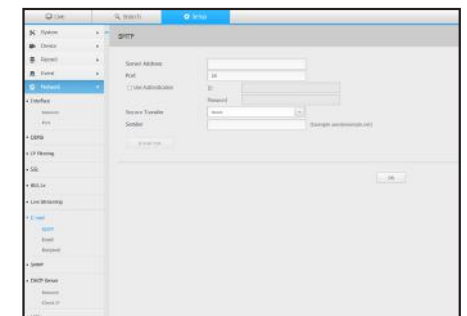

Event

You can set the event interval and specify which events the server sends mails for.

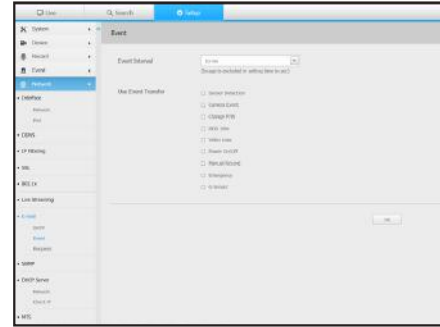

Recipient

You can set groups and recipients to receive emails.

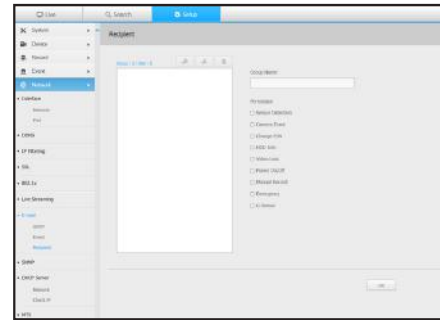

SNMP

Using the SNMP protocol, the system or network administrator can remotely monitoring the network devices and sets the environment.

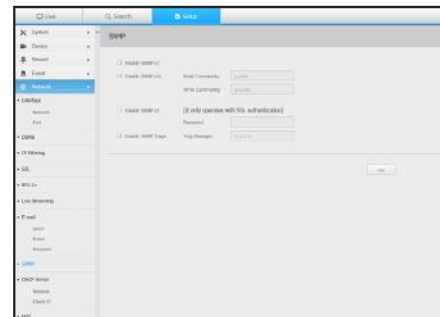

DHCP Server

Network

You can set the internal DHCP server and assign an IP address to the network camera.

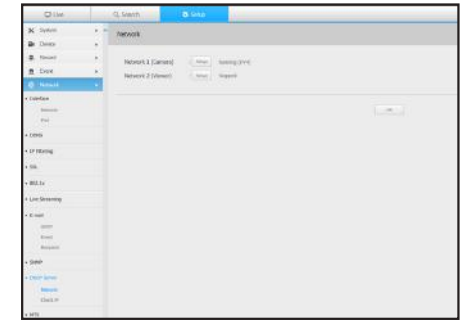

Check IP

You can check the IP and MAC currently used through the DHCP server, and the connected network port.

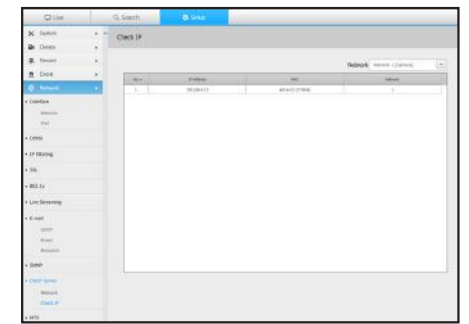

setup viewer

MTS

Vehicle information, real-time location, events and video are transmitted to SSM-MTS (Mobile Tracking System).

MTS

Sets the MTS server address and whether tracking, event notification, and JPEG push are enabled.

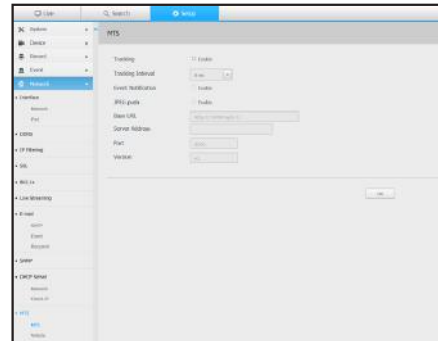

Vehicle

Sends vehicle information to MTS.

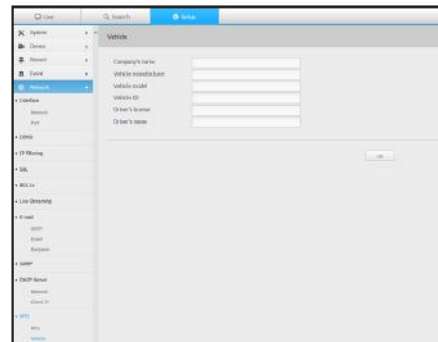

SEC BACKUP VIEWER

You can play a file that is backed up in the format of SEC.

Backup in SEC format produces backup data file, library file and self-executable viewer file.

If you run the backup file viewer, the backup data file will be played.









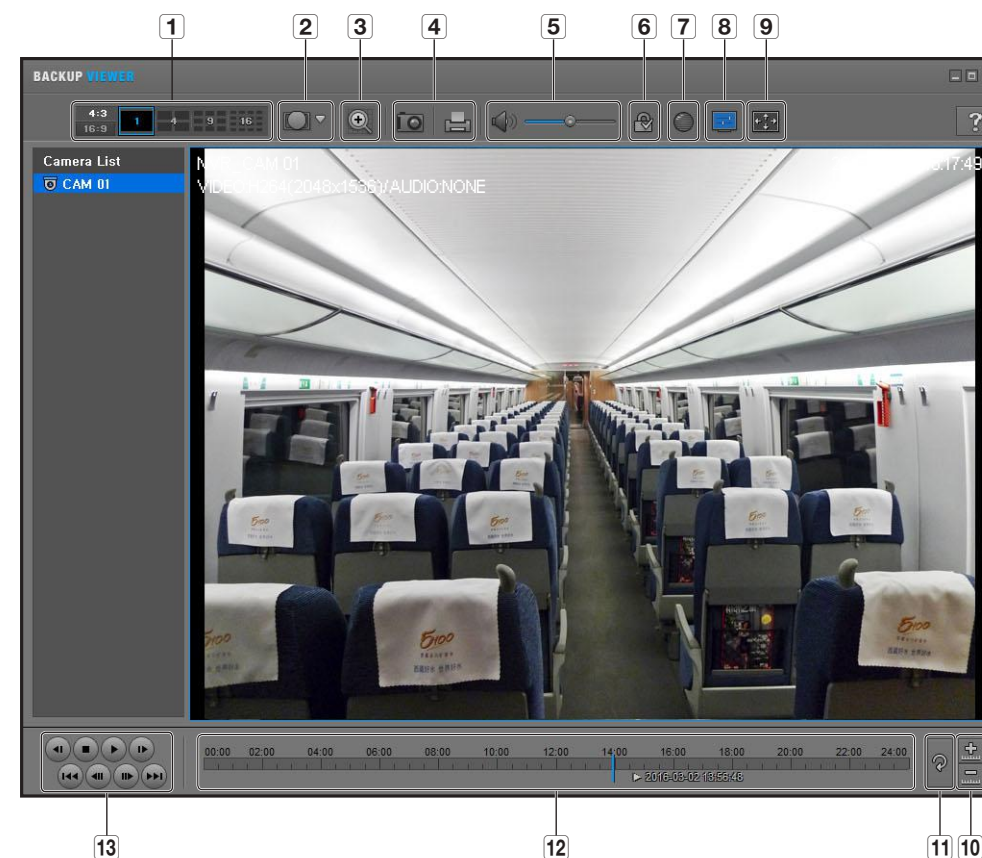

Recommended System Requirements













PCs with a lower specification than the recommended below may not fully support forward/backward and high-speed playback.

PC specifications

| Name | Minimum requirements | Recommended |
|--------------------|--|----------------------------|
| CPU | Intel Core 2 Quad 2.5GHz | Intel i7(3.5GHz) or Higher |
| RAM | 2GB or Higher | 4GB or Higher |
| HDD | 200GB or Higher | 500GB or Higher |
| VGA memory | 512MB or Higher | 2GB or Higher |
| Display resolution | 1280x1024 | 1920x1080 or Higher |
| OS | Windows 7, 8, 10, Mac OS X(10.8 or Higher) | |
| Browser | 1) Non-Plugin Webviewer - Google Chrome 47, MS Edge 20 2) Plugin Webviewer - MS IE 11, Apple Safari 9 (Mac OS X Only) | |



| Item | Description |
|---|---|
| 1 Split screen   | Selects screen ratio to display. The screen is changed to a split screen. |
| 2 Fish eye view mode   | If <  > is pushed, it is possible to change to a fish eye installation type. It is possible to select WALL/GROUND/CEILING mode according to the installation place. The fish eye view mode on the current screen can be changed independently on each split. |
| 3 Digital Zoom  | Enlarge the image by up to 100 times as big as the current one. Press the Zoom In () button to enlarge the image; press the Zoom Out () button to shrink the image. You can also use the slide bar () in the pop-up window to zoom in/out. Press () on a size-changed video to restore the default zoom factor (100%). If you enlarge the image by more than 200%, the enlarged area will be marked on the digital zooming screen. Click on the marked area and move it to a desired position. The digital zooming is applied to all backup viewer. When the digital zooming is canceled, the video size will restore the default rate of 100%. |

| Item | | Description |
|------|-----------------------------------|--|
| 4 | Screen Printout |  Saves the current video's image as in an image file. Supports JPEG file format. |
| | |  Prints out the current screen. You should have installed the appropriate printer driver before you can print out the screen. |
| 5 | Audio |  A toggle button. Each time you press this button, the audio output will toggle between activated and deactivated. |
| | |  You can adjust the volume level from 0 to 100. |
| 6 | Watermark |  Press the button to enable file tampering detection, to detect data file forging. |
| 7 | Deinterlace |  You can enable the De-interlace function. |
| 8 | Show OSD |  Check the OSD checkbox to display the OSD information on the backup playback screen. Information such as backup date, day of the week, time, model name, and channel number will be displayed on the screen. |
| 9 | Maintain aspect ratio/Full screen |  Maintains the aspect ratio of the playback screen. |
| | |  Plays the video on a full screen. |
| 10 | Enlarge / Reduce Timeline |  Collapses the time range that is displayed on the range bar of the storage time. You can collapse the range bar until the overall range is shortened to 24 hours. |
| | |  Enlarges the time range that is displayed on the range bar of the storage time. You can enlarge the range bar until the overall range is extended to 1 minute. |
| 11 | Restore Timeline |  Restores the timeline to the default. |
| 12 | Display of storage time range | Displays the time range of a stored video file. You can move the gridline of the range bar to select a time point to play. |
| 13 | Playback Control |  You can adjust the video playback of the timeline. |

USING VIRTUAL KEYBOARD

1. For alphanumeric inputs, the virtual keyboard window appears.
2. Using a mouse, click on the desired character tab.
3. In the upper text input box of the virtual keyboard, there displays a list of candidate words containing the selected character.
4. Select a word from the list, or use the keyboard to enter the whole word.
 - If there are many of candidate words, use < < > > buttons to move between them forward and backward.
5. Select <OK>. Entered word is applied.
 - If you want to enter a special character or uppercase letters, select <Caps Lock> or <Shift>.
 - Using the virtual keyboard is the same to a normal keyboard use in your region.
 - Your ID can contain any combination of upper/lowercase alphabet letters and numbers.
 - If the password length is 8 to 9 digits, you can combine at least three different types of the following characters: upper/lowercase alphabets, numbers, and special characters.
 - If the password length is 10 digits or more, you can combine at least two different types of the following characters: upper/lowercase alphabets, numbers, and special characters.



TROUBLESHOOTING

| Problem | Action |
|--|---|
| Live video will be slow or cut off. | <ul style="list-style-type: none"> • The frame number set for multiple data transmission set in camera or network environment could differ from the actual rate of transmission. Right click with the mouse button and select <Channel Information> to check the number of incoming frames for each channel and the actual number of framed played. Basically, when you register a camera, the Live4NVR profile is created and the rate is set to H.264.800*600fps. If necessary, go to <Menu> → <Device> → <Camera> → <Camera Setting> and change the number of frames. • If you keep seeing video slow down or cut off, then check the network environment or camera condition. |
| The system does not turn on and the indicator on the front panel does not work at all. | <ul style="list-style-type: none"> • Check if the power supply system is properly connected. • Check the system for the input voltage from the power source. • If the problem persists even after you have taken the above actions, check the power supplier and replace it with a new one if neccessary. • Check inside if the cables are properly connected. (SMPS, FRONT) |
| Some channels display just a black screen even if they receive video sources. | <ul style="list-style-type: none"> • Check if the camera is properly supplied with power. • Check the video output connecting the camera's webviewer. • Check if the network port is properly connected and the network setting is set correctly. • Change the hub supporting Gigabit, it may solves. |
| The screen displays the logo image repeatedly. | <ul style="list-style-type: none"> • This may occur from a problem with the main board, or the related software is corrupt. Contact the nearest service center for more information. |
| The Channel button does not work on the Live screen. | <ul style="list-style-type: none"> • The Channel button does not work if the current screen is in the event monitoring mode. |
| The cursor will not move to the Start button when I start the calendar search. | <ul style="list-style-type: none"> • Check if the channel and the date that you want to play are marked with the V symbol. Both channel and date should be checked before you can start playing with the Start button. |
| No video is played on the connected monitor. | <ul style="list-style-type: none"> • Check if the necessary cables are connected to the monitor properly. • Some monitors do not support the NVR output (HDMI or VGA). (NVR output resolution : VGA : 1280*720, 1280*1024, 1920*1080, HDMI : 720P, 1080P, 1440P, 2160P) Check the monitor resolution • For a 4K video, it is recommended to use a premium HDMI cable. |
| Logo screen on bootup stalls in the [] state. | <ul style="list-style-type: none"> • The HDD may have problems. Visit your nearest customer service center to check the HDD. |

| Problem | Action |
|---|---|
| No response controlling PTZ in the live viewer. | <ul style="list-style-type: none"> • Check the registered Camera if it support PTZ function. |
| The camera is not connected or the PC fails to connect to the product. | <ul style="list-style-type: none"> • Check if the network cable is connected properly. • Ensure that you have set Network – Connection Mode. • Check the IP setting of the PC or camera. • Try the Ping Test. • Check if there is a different device near the product uses the same IP. |
| I registered a camera, but the web viewer does not show live video. | <ul style="list-style-type: none"> • After registering a camera, a user need to edit/save the desired layout, before the screen split mode and live screen fit for the setting appears. |
| In the web viewer, the screen does not switch automatically. | <ul style="list-style-type: none"> • You need to select the desired layout for sequence operation, in the automatic switching menu. |
| The Live screen is too bright or too dark. | <ul style="list-style-type: none"> • Check the video settings of the registered camera. |
| A message of "Need to reset date/time." Is displayed on the screen. | <ul style="list-style-type: none"> • This message is displayed if there occurs a problem with the time setting of the internal clock or an error in the clock itself. Contact the retailer or the service center for more information. |
| The time bar is not displayed in Search mode. | <ul style="list-style-type: none"> • The timeline can switch between normal and extension mode. In extension mode, the time bar may not be displayed in the current timeline. Switch to normal mode or use the left or right button to navigate through the time bar. |
| The "NO HDD" icon and an error message are displayed. | <ul style="list-style-type: none"> • If you do not format your purchased HDD at all or in a format supported by NVR, a "NO HDD" icon () will be displayed at the top left. When the "NO HDD" icon is displayed, go to "Menu > Storage Device" and check the HDD connection status and format the HDD. • If the problem persists in a normal condition, contact the nearest service center to have the HDD checked by the service personnel. |
| I have installed an additional HDD on the NVR but it does not recognize the HDD. | <ul style="list-style-type: none"> • See the compatibility list to check if the additional HDD is supported by the NVR. For the compatibility list, contact the retailer where you purchased the NVR. |
| I have connected an external storage device (USB Memory, USB HDD) to the NVR but the NVR seems not to recognize it. | <ul style="list-style-type: none"> • See the compatibility list of external storage devices to check if the connected device is supported by the NVR. For the compatibility list, contact the retailer where you purchased the NVR. |
| If I press the ESC key in full screen mode of the WebViewer, the system does not switch to a normal split mode. | <ul style="list-style-type: none"> • Press the ALT+TAB keys to select 'ACTIVE MOVIE' and press the ESC key again. The system will switch to a normal split mode. |

| Problem | Action |
|---|--|
| I found it difficult to configure the network settings if using the default search, backup and router settings. | <ul style="list-style-type: none"> • For more information, refer to the user manual. • If you want to check the basics of the product for a quick start, refer to the quick start guide (backup, search). • If you use the router for network connection, refer to the "Connecting and Setting the Network" section in this manual. |
| I forgot the password. | <ul style="list-style-type: none"> • Contact the NVR administrator for help. |
| Backup data is just not played by the PC or NVR. | <ul style="list-style-type: none"> • When you are backing up data, you have choices about the player either: PC or NVR. Make your selection before proceeding. • If you are using the PC to play the data, the format of the backup file should be either SEC. • If you are using the NVR for this purpose, formatting backup files should be done by the NVR. |
| Recording does not work. | <ul style="list-style-type: none"> • If your player does not display a Live image at all, that indicates recording does not work so first check if you see an image on the screen. • Recording does not work if the recording settings are not properly configured Scheduled Record: Specify a desired time in Menu – Record – Recording Schedule. Recording will start at the specified time. <ul style="list-style-type: none"> - <Continuous> Record: Recording will proceed in any conditions at the specified time. - <Event> Record: When an event occurs, recording will perform only if the event is of alarm, motion detection and video loss. If there is no event found, recording will not perform. - <Continuous / Event> Record: If there is no event found, Continuous recording will perform. Whereas, if an event occurs, Event recording will perform. |
| The image quality of the recording data is not good. | <ul style="list-style-type: none"> • Increase the resolution and quality level in Menu – Record – Quality / Resolution. <ol style="list-style-type: none"> 1) Resolution: Select a bigger size when specifying the recording size. The recording image in the CIF format shows a deteriorated quality as it is enlarged from a small-sized image. 2) Record Quality: Specify a bigger level for the recording quality. • If you increase the resolution and the recording quality, the data size increases accordingly. So the HDD will be filled faster. Overwriting will overwrite the existing data so recording will proceed at a shorter interval. |
| Frame rate of the actual recording does not match that of configured to the camera. | <ul style="list-style-type: none"> • If multiple profiles were applied to one camera for video transmission, the actual video stream can be serviced by the camera at a lower frame rate than specified. Configure your camera to use one profile for data streaming as possible. For example, if you set the same profile for recording and network profiles, the actual recording is made at the specified frame rate. Still, live video display using split screen mode may apply yet another profile to camera in accordance with the used screen mode. Note that allowed limit bitrate for recording / recording settings should be set to be bigger values than that of camera's feed. |

| Problem | Action |
|--|---|
| In the recording setting screen, the permitted level for a specific channel is displayed in orange. | <ul style="list-style-type: none"> • If the input data is greater than the permitted level for each channel, it is displayed in orange. Set the permitted data limit to higher than the amount of input data. • If the sum of input data for each channel exceeds the limit, the alarm icon will be displayed. In this case, the channel exceeding the input limit does not record the entire frame, but it records the main frame only(one or two per sec). |
| In the live screen, the [] icon is displayed and the message window saying " recording data load exceeds the limit. Check it in the record setting." pops up. | <ul style="list-style-type: none"> • If the sum of input data for each channel exceeds the limit, the alarm icon and the pop up window will be displayed. In this case, the channel exceeding the input limit does not record the entire frame, but it records the main frame only(one or two per sec). • Set the permitted data limit to higher than the amount of input data entered in the record Setup menu. |
| Recording is not performed in accordance with the settings. | <ul style="list-style-type: none"> • If the recording status displays 'Exceeds the maximum hard disc performance', set the recording size according to the recording performance specifications for each HDD condition. (See the "Menu Setup > Setting the Recording" page in the Table of Contents.) |
| The recording screen will slow down. | <ul style="list-style-type: none"> • Check whether the recording performance specifications for each HDD condition match the actual recording settings. (See the "Menu Setup > Setting the Recording" page in the Table of Contents.) • If the data volume of a video exceeds the playing performance, only the main frame is played. (See the "Product Specification Manual".) |
| If recording loss persists continuously | <ul style="list-style-type: none"> • Reset the camera recording profile to let the entire recording bps size fit the recording performance for each HDD condition. (See the "Menu Setup > Setting the Recording" page in the Table of Contents.) <ul style="list-style-type: none"> ▪ Check the HDD status and determine whether inspection or replacement is necessary. (See the "Storage Device" page under "Menu Setup > Setting the Recording" in the Table of Contents.) |
| If the plugin fails to install when trying to access the camera website from the camera setup of your web viewer | <ul style="list-style-type: none"> • Try again after setting the compatibility view in the web page of the NVR web viewer. |



Hanwha Techwin cares for the environment at all product manufacturing stages, and is taking measures to provide customers with more environmentally friendly products.

The Eco mark represents Hanwha Techwin's devotion to creating environmentally friendly products, and indicates that the product satisfies the EU RoHS Directive.



Correct Disposal of This Product (Waste Electrical & Electronic Equipment)

(Applicable in the European Union and other European countries with separate collection systems)

This marking on the product, accessories or literature indicates that the product and its electronic accessories (e.g. charger, headset, USB cable) should not be disposed of with other household waste at the end of their working life. To prevent possible harm to the environment or human health from uncontrolled waste disposal, please separate these items from other types of waste and recycle them responsibly to promote the sustainable reuse of material resources.

Household users should contact either the retailer where they purchased this product, or their local government office, for details of where and how they can take these items for environmentally safe recycling.

Business users should contact their supplier and check the terms and conditions of the purchase contract. This product and its electronic accessories should not be mixed with other commercial wastes for disposal.



Correct disposal of batteries in this product

(Applicable in the European Union and other European countries with separate battery return systems.)

This marking on the battery, manual or packaging indicates that the batteries in this product should not be disposed of with other household waste at the end of their working life. Where marked, the chemical symbols Hg, Cd or Pb indicate that the battery contains mercury, cadmium or lead above the reference levels in EC Directive 2006/66. If batteries are not properly disposed of, these substances can cause harm to human health or the environment.

To protect natural resources and to promote material reuse, please separate batteries from other types of waste and recycle them through your local, free battery return system.

Head Office

6, Pangyo-ro 319 beon-gil, Bundang-gu, Seongnam-si,
Gyeonggi-do, 463-400 Rep. of KOREA

Tel : +82.70.7147.8753 Fax : +82.31.8018.3740

www.hanwha-security.com

Hanwha Techwin America

500 Frank W. Burr Blvd. Suite 43 Teaneck, NJ 07666

Toll Free +1.877.213.1222 Direct +1.201.325.6920

Fax +1.201.373.0124

www.hanwhasecurity.com

Hanwha Techwin Europe

Heriot House, Heriot Road, Chertsey, Surrey, KT16 9DT, United Kingdom

Tel +44.1932.57.8100 Fax +44.1932.57.8101

www.hanwha-security.eu
