



# Network Video Recorder

Quick Start Guide

# TABLE OF CONTENTS

<b>Chapter1 Panels Description .....</b>	<b>7</b>
1.1 Front Panel.....	7
1.2 Rear Panel .....	8
DS-7100NI-Q1 and DS-7100NI-Q1/M Series .....	8
DS-7100NI-Q1/P and DS-7100NI-Q1/P/M Series.....	9
<b>Chapter 2 Installation and Connections .....</b>	<b>10</b>
2.1 NVR Installation.....	10
2.2 Hard Disk Installation .....	10
2.3 HDD Storage Calculation Chart .....	11
<b>Chapter 3 Menu Operation .....</b>	<b>13</b>
3.1 Startup and Shutdown.....	13
3.2 Activating Your Device .....	13
3.3 Using the Unlock Pattern for Login.....	15
3.4 User Login .....	16
3.5 Using the Setup Wizard .....	16
3.6 Network Settings.....	17
3.7 Adding IP Cameras.....	17
3.8 Live View.....	18
3.9 Recording Settings.....	18
3.10 Playback .....	19
<b>Chapter 4 Accessing by Web Browser .....</b>	<b>21</b>

### **Quick Start Guide**

COPYRIGHT ©2018 Hangzhou Hikvision Digital Technology Co., Ltd.

#### **ALL RIGHTS RESERVED.**

Any and all information, including, among others, wordings, pictures, graphs are the properties of Hangzhou Hikvision Digital Technology Co., Ltd. or its subsidiaries (hereinafter referred to be “Hikvision”). This user manual (hereinafter referred to be “the Manual”) cannot be reproduced, changed, translated, or distributed, partially or wholly, by any means, without the prior written permission of Hikvision. Unless otherwise stipulated, Hikvision does not make any warranties, guarantees or representations, express or implied, regarding to the Manual.

#### **About this Manual**

This Manual is applicable to Network Video Recorder (NVR).

The Manual includes instructions for using and managing the product. Pictures, charts, images and all other information hereinafter are for description and explanation only. The information contained in the Manual is subject to change, without notice, due to firmware updates or other reasons. Please find the latest version in the company website (<http://overseas.hikvision.com/en/>).

Please use this user manual under the guidance of professionals.

#### **Trademarks Acknowledgement**

**HIKVISION** and other Hikvision’s trademarks and logos are the properties of Hikvision in various jurisdictions. Other trademarks and logos mentioned below are the properties of their respective owners.

#### **Legal Disclaimer**

TO THE MAXIMUM EXTENT PERMITTED BY APPLICABLE LAW, THE PRODUCT DESCRIBED, WITH ITS HARDWARE, SOFTWARE AND FIRMWARE, IS PROVIDED “AS IS”, WITH ALL FAULTS AND ERRORS, AND HIKVISION MAKES NO WARRANTIES, EXPRESS OR IMPLIED, INCLUDING WITHOUT LIMITATION, MERCHANTABILITY, SATISFACTORY QUALITY, FITNESS FOR A PARTICULAR PURPOSE, AND NON-INFRINGEMENT OF THIRD PARTY. IN NO EVENT WILL HIKVISION, ITS DIRECTORS, OFFICERS, EMPLOYEES, OR AGENTS BE LIABLE TO YOU FOR ANY SPECIAL, CONSEQUENTIAL, INCIDENTAL, OR INDIRECT DAMAGES, INCLUDING, AMONG OTHERS, DAMAGES FOR LOSS OF BUSINESS PROFITS, BUSINESS INTERRUPTION, OR LOSS OF DATA OR DOCUMENTATION, IN CONNECTION WITH THE USE OF THIS PRODUCT, EVEN IF HIKVISION HAS BEEN ADVISED OF THE POSSIBILITY OF SUCH DAMAGES.

REGARDING TO THE PRODUCT WITH INTERNET ACCESS, THE USE OF PRODUCT SHALL BE WHOLLY AT YOUR OWN RISKS. HIKVISION SHALL NOT TAKE ANY RESPONSIBILITIES FOR ABNORMAL OPERATION, PRIVACY LEAKAGE OR OTHER DAMAGES RESULTING FROM CYBER ATTACK, HACKER ATTACK, VIRUS INSPECTION, OR OTHER INTERNET SECURITY RISKS; HOWEVER, HIKVISION WILL PROVIDE TIMELY TECHNICAL SUPPORT IF REQUIRED.

SURVEILLANCE LAWS VARY BY JURISDICTION. PLEASE CHECK ALL RELEVANT LAWS IN YOUR JURISDICTION BEFORE USING THIS PRODUCT IN ORDER TO ENSURE THAT YOUR USE CONFORMS THE APPLICABLE LAW. HIKVISION SHALL NOT BE LIABLE IN THE EVENT THAT THIS PRODUCT IS USED WITH ILLEGITIMATE PURPOSES.

IN THE EVENT OF ANY CONFLICTS BETWEEN THIS MANUAL AND THE APPLICABLE LAW, THE LATER PREVAILS.

### Regulatory Information

#### FCC Information

Please take attention that changes or modification not expressly approved by the party responsible for compliance could void the user's authority to operate the equipment.

**FCC compliance:** This equipment has been tested and found to comply with the limits for a Class A digital device, pursuant to part 15 of the FCC Rules. These limits are designed to provide reasonable protection against harmful interference when the equipment is operated in a commercial environment. This equipment generates, uses, and can radiate radio frequency energy and, if not installed and used in accordance with the instruction manual, may cause harmful interference to radio communications. Operation of this equipment in a residential area is likely to cause harmful interference in which case the user will be required to correct the interference at his own expense.

#### FCC Conditions

This device complies with part 15 of the FCC Rules. Operation is subject to the following two conditions:

1. This device may not cause harmful interference.
2. This device must accept any interference received, including interference that may cause undesired operation.

#### EU Conformity Statement

 This product and - if applicable - the supplied accessories too are marked with "CE" and comply therefore with the applicable harmonized European standards listed under the EMC Directive 2014/30/EU, the LVD Directive 2014/35/EU, the RoHS Directive 2011/65/EU.

 2012/19/EU (WEEE directive): Products marked with this symbol cannot be disposed of as unsorted municipal waste in the European Union. For proper recycling, return this product to your local supplier upon the purchase of equivalent new equipment, or dispose of it at designated collection points. For more information see: [www.recyclethis.info](http://www.recyclethis.info)

 2006/66/EC (battery directive): This product contains a battery that cannot be disposed of as unsorted municipal waste in the European Union. See the product documentation for specific battery information. The battery is marked with this symbol, which may include lettering to indicate cadmium (Cd), lead (Pb), or mercury (Hg). For proper recycling, return the battery to your supplier or to a designated collection point. For more information see: [www.recyclethis.info](http://www.recyclethis.info)

#### Industry Canada ICES-003 Compliance

This device meets the CAN ICES-3 (A)/NMB-3(A) standards requirements.



## Applicable Models

This manual is applicable to the models listed in the following table.

Series	Model
DS-7100NI-Q1	DS-7104NI-Q1
	DS-7108NI-Q1
DS-7100NI-Q1/P	DS-7104NI-Q1/4P
	DS-7108NI-Q1/8P
DS-7100NI-Q1/M	DS-7104NI-Q1/M
	DS-7108NI-Q1/M
DS-7100NI-Q1/P/M	DS-7104NI-Q1/4P/M
	DS-7108NI-Q1/8P/M

## Symbol Conventions

The symbols that may be found in this document are defined as follows.

Symbol	Description
 <b>NOTE</b>	Provides additional information to emphasize or supplement important points of the main text.
 <b>WARNING</b>	Indicates a potentially hazardous situation, which if not avoided, could result in equipment damage, data loss, performance degradation, or unexpected results.
 <b>DANGER</b>	Indicates a hazard with a high level of risk, which if not avoided, will result in death or serious injury.

### Safety Instructions

- Proper configuration of all passwords and other security settings is the responsibility of the installer and/or end-user.
- In the use of the product, you must be in strict compliance with the electrical safety regulations of the nation and region. Please refer to technical specifications for detailed information.
- Input voltage should meet both the SELV (Safety Extra Low Voltage) and the Limited Power Source with 100~240 VAC, 48 VDC or 12 VDC according to the IEC60950-1 standard. Please refer to technical specifications for detailed information.
- Do not connect several devices to one power adapter as adapter overload may cause over-heating or a fire hazard.
- Please make sure that the plug is firmly connected to the power socket.
- If smoke, odor or noise rise from the device, turn off the power at once and unplug the power cable, and then please contact the service center.
- If the POE ports of device do not comply with Limited Power Source, the additional equipment connected to POE ports shall have fire enclosure.
- The USB interface of the /P devices can be connected with the mouse and U-flash disk storage device only.

### Preventive and Cautionary Tips

Before connecting and operating your device, please be advised of the following tips:

- Ensure unit is installed in a well-ventilated, dust-free environment.
- Unit is designed for indoor use only.
- Keep all liquids away from the device.
- Ensure environmental conditions meet factory specifications.
- Ensure unit is properly secured to a rack or shelf. Major shocks or jolts to the unit as a result of dropping it may cause damage to the sensitive electronics within the unit.
- Use the device in conjunction with an UPS if possible.
- Power down the unit before connecting and disconnecting accessories and peripherals.
- A factory recommended HDD should be used for this device.
- Improper use or replacement of the battery may result in hazard of explosion. Replace with the same or equivalent type only. Dispose of used batteries according to the instructions provided by the battery manufacturer.

## Power Supply Instructions

Use only power supplies listed in the user instructions.

NVR Models	Standard	Power Supply Models	Manufacturer
DS-7104NI-Q1 HWN-2104H DS-7108NI-Q1 HWN-2108H	European	MSA-C1500IC12.0-18P-DE	MOSO Power Supply Technology Co.,Ltd
		ADS-26FSG-12 12018EPG	Shenzhen HONOR Electronic Co., Ltd
		KL-AD3060VA	Xiamen Keli Electronics Co.,Ltd
		KPD-018-VI	Channel Well Technology Co.,Ltd
DS-7104NI-Q1/M HWN-2104MH DS-7108NI-Q1/M HWN-2108MH	British	ADS-25FSG-12 12018GPB	Shenzhen HONOR Electronic Co., Ltd
		MSA-C1500IC12.0-18P-GB	MOSO Power Supply Technology Co.,Ltd
		ADS-26FSG-12 12018EPB	Shenzhen HONOR Electronic Co., Ltd
DS-7104NI-Q1/4P HWN-2104H-4P DS-7104NI-Q1/4P/M HWN-2104MH-4P	Universal	MSP-Z1360IC48.0-65W	MOSO Power Supply Technology Co.,Ltd
		MSA-Z1040IS48.0-65W-Q	MOSO Power Supply Technology Co.,Ltd
		MSA-Z1360IS48.0-65W-Q	MOSO Power Supply Technology Co.,Ltd

 **NOTE**

- The power supplies list above is for EU countries only.
- The power supplies list is subject to change without prior notice.

# Chapter1 Panels Description

## 1.1 Front Panel

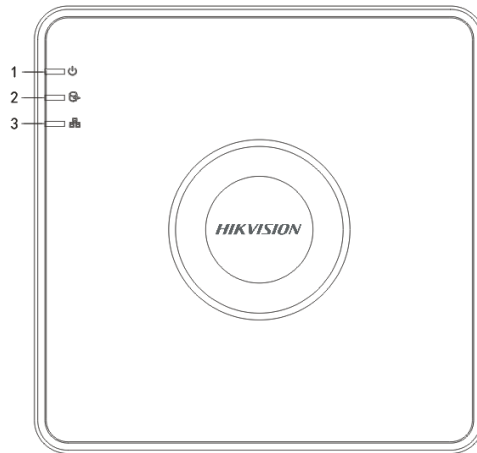

Figure 1-1 DS-7100NI-Q1 (/P) Series

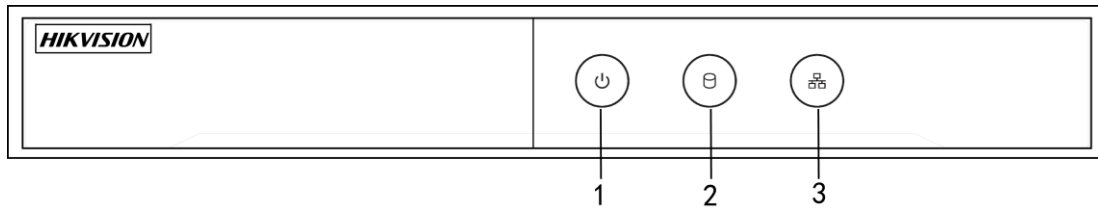

Figure 1-2 DS-7100NI-Q1 (/P)/M Series

Table 1-1 Description of Front Panel

No.	Icon	Description
1		Indicator turns red when NVR is powered up.
2		Indicator lights in red when data is being read from or written to HDD.
3		Indicator blinks blue when network connection is functioning properly.



## 1.2 Rear Panel

### DS-7100NI-Q1 and DS-7100NI-Q1/M Series

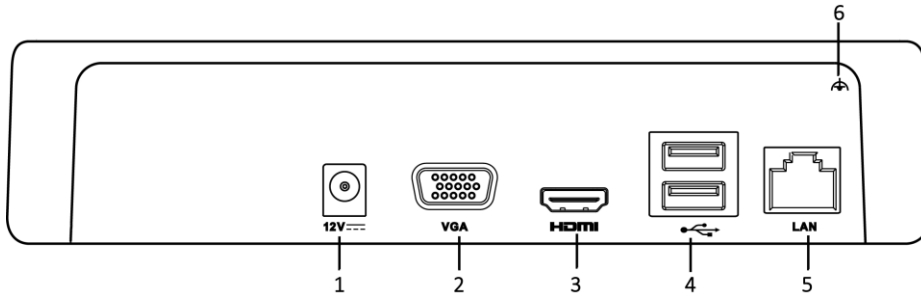

Figure 1-3 DS-7100NI-Q1 Rear Panel

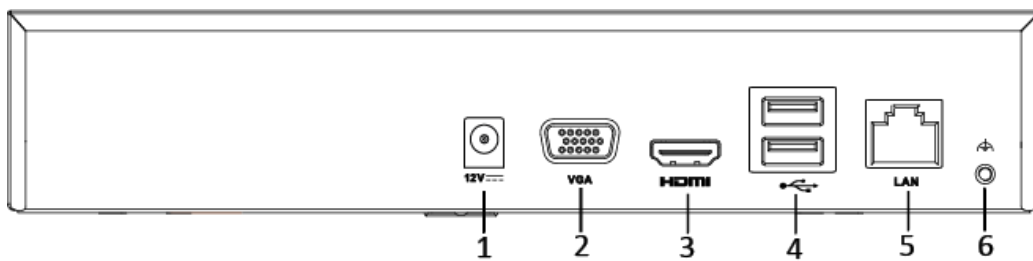

Figure 1-4 DS-7100NI-Q1/M Rear Panel

Table 1-2 Description of Rear Panel

No.	Item	Description
1	Power Supply	12 VDC power supply.
2	VGA Interface	DB9 connector for VGA output. Display local video output and menu.
3	HDMI Interface	HDMI video output connector.
4	USB Interface	Universal Serial Bus (USB) ports for additional devices such as USB mouse and USB Hard Disk Drive (HDD).
5	LAN Network Interface	10 /100 Mbps self-adaptive Ethernet interface.
6	Ground	Ground (needs to be connected when NVR starts up).

DS-7100NI-Q1/P and DS-7100NI-Q1/P/M Series

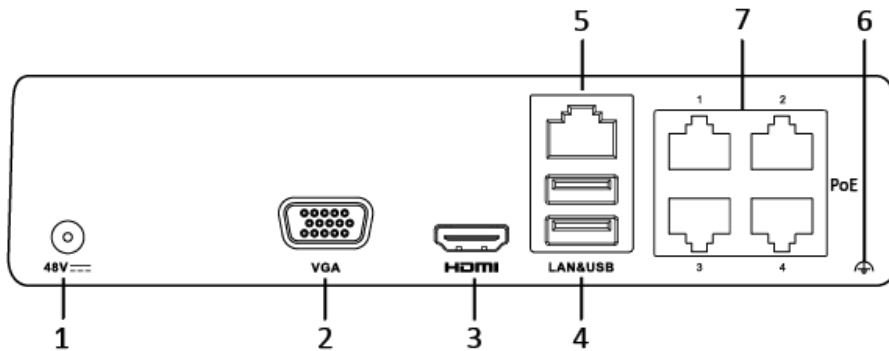

Figure 1-5 DS-7100NI-Q1/P Rear Panel

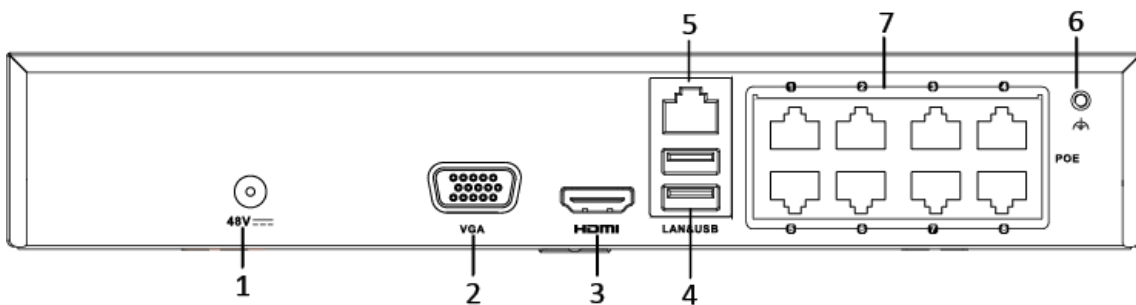

Figure 1-6 DS-7100NI-Q1/P/M Rear Panel

Table 1-3 Description of Rear Panel

No.	Item	Description
1	Power Supply	12 VDC power supply.
2	VGA Interface	DB9 connector for VGA output. Display local video output and menu.
3	HDMI Interface	HDMI video output connector.
4	USB Interface	Universal Serial Bus (USB) ports for additional devices such as USB mouse and USB Hard Disk Drive (HDD).
5	LAN Network Interface	10 /100 Mbps self-adaptive Ethernet interface.
6	Ground	Ground (needs to be connected when NVR starts up).
7	Network Interfaces with PoE function	Network interfaces for the cameras and to provide power over Ethernet. 4 interfaces for /4P models and 8 interfaces for /8P models.

## Chapter 2 Installation and Connections

### 2.1 NVR Installation

During installation of the NVR:

- Use brackets for rack mounting.
- Ensure ample room for audio and video cables.
- When routing cables, ensure that the bend radius of the cables are no less than five times than its diameter.
- Connect the alarm cable.
- Allow at least 2cm (≈0.75-inch) of space between racks mounted devices.
- Ensure the NVR is grounded.
- Environmental temperature should be within the range of -10 to +55° C, +14 to +131° F.
- Environmental humidity should be within the range of 10% to 90%.

### 2.2 Hard Disk Installation

Before you start:

Disconnect the power from the NVR before installing a hard disk drive (HDD). A factory recommended HDD should be used for this installation.

Tools Required: Screwdriver.

Step 1 Remove the cover from device by unfastening the screws on panels.

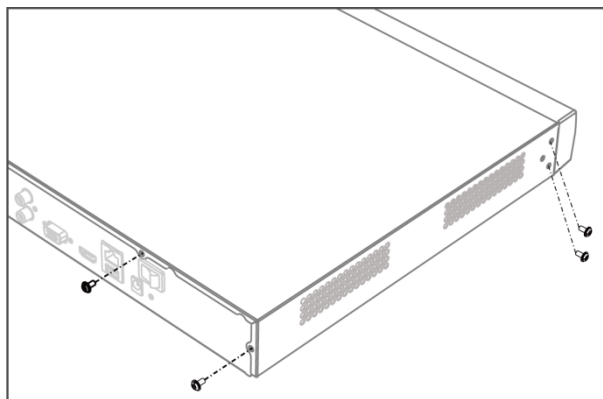

Figure 2-1 Remove Cover

Step 2 Connect the data cable and power cable.

- 1) Connect one end of data cable to the device motherboard.
- 2) Connect the other end of data cable to HDD.
- 3) Connect one end of power cable to HDD.

4) Connect the other end of power cable to the device motherboard.

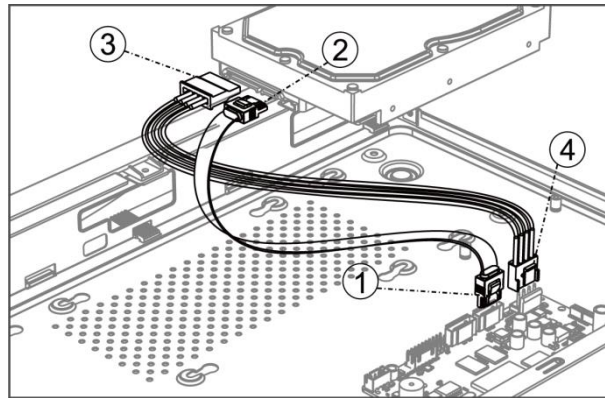

Figure 2-2 Connect Cables

Step 3 Set the device up, match HDD screw threads with the reserved holes on the device bottom, and fix HDD with screws.

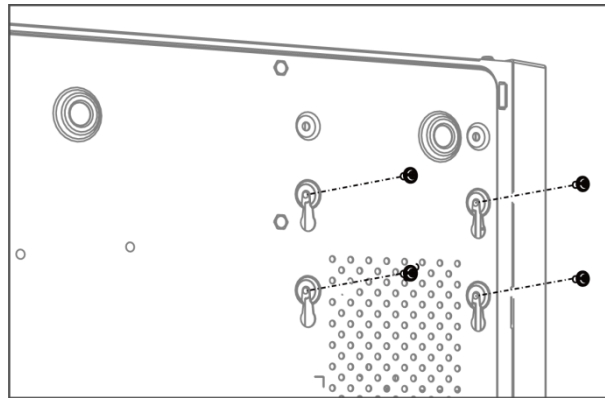

Figure 2-3 Fix HDD to Device Bottom

Step 4 (Optional) Repeat the steps above to install other HDDs.

Step 5 Reinstall the device cover and fasten screws.

## 2.3 HDD Storage Calculation Chart

The following chart shows an estimation of storage space used based on recording at one channel for an hour at a fixed bit rate.

Bit Rate	Storage Used
96K	42M
128K	56M
160K	70M
192K	84M
224K	98M
256K	112M
320K	140M
384K	168M
448K	196M
512K	225M
640K	281M
768K	337M
896K	393M
1024K	450M
1280K	562M
1536K	675M
1792K	787M
2048K	900M
4096K	1.8G
8192K	3.6G
16384K	7.2G

 **NOTE**

Please note that supplied values for storage space used is just for reference. The storage values in the chart are estimated by formulas and may have some deviation from actual value.

## Chapter 3 Menu Operation

### 3.1 Startup and Shutdown

Proper startup and shutdown procedures are crucial to expanding the life of the NVR.

To start your NVR:

**Step 1** Check the power supply is plugged into an electrical outlet. It is **HIGHLY** recommended that an Uninterruptible Power Supply (UPS) be used in conjunction with the device. The Power button) on the front panel should be red, indicating the device is receiving the power.

**Step 2** Press the power switch on the panel. The Power LED should turn blue. The unit will begin to start.

After the device starts up, the wizard will guide you through the initial settings, including modifying password, date and time settings, network settings, HDD initializing, and recording.

To shut down the NVR:

**Step 1** Enter the Shutdown menu.

Menu > Shutdown

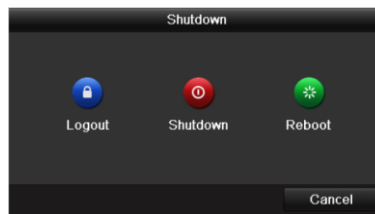

Figure 3-1 Shutdown

**Step 2** Select **Shutdown**.

**Step 3** Click **Yes**.

### 3.2 Activating Your Device

**Purpose:**

For the first-time access, you need to activate the device by setting an admin password. No operation is allowed before activation. You can also activate the device via Web Browser, SADP or client software.

**Step 1** Input the same password in the text field of **Create New Password** and **Confirm New Password**.

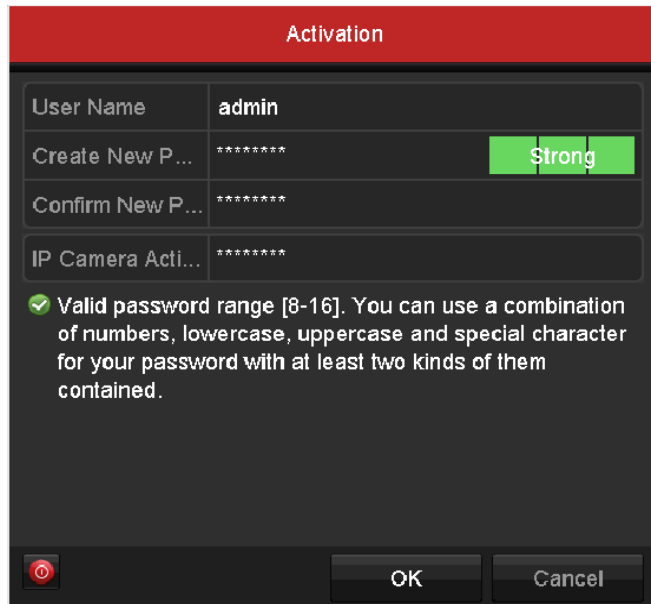

Figure 3-2 Set Admin Password

---

 **WARNING**

**STRONG PASSWORD RECOMMENDED**—We highly recommend you create a strong password of your own choosing (Using a minimum of 8 characters, including at least three of the following categories: upper case letters, lower case letters, numbers, and special characters.) in order to increase the security of your product. And we recommend you reset your password regularly, especially in the high security system, resetting the password monthly or weekly can better protect your product.

---

Step 2 In the **IP Camera Activation** text field, enter the password to activate the IP camera (s) connected to the device.

Step 3 Click **OK**.

 **NOTE**

For the old version device, if you upgrade it to the new version, the following dialog box will pop up once the device starts up. You can click **YES** and follow the wizard to set a strong password.

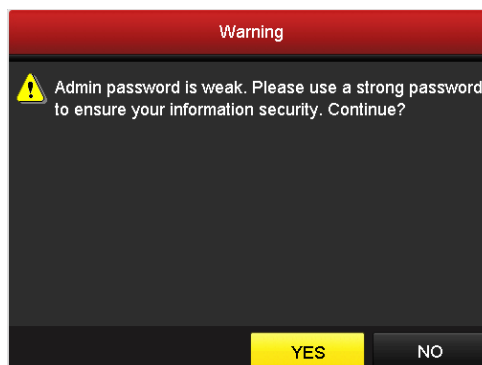

Figure 3-3 Warning of Weak Password

### 3.3 Using the Unlock Pattern for Login

For the Admin user, you can configure the unlock pattern for device login.

After the device is activated, you can enter the following interface to configure the device unlock pattern.

Step 1 Use the mouse to draw a pattern among the 9 dots on the screen. Release the mouse when the pattern is done.

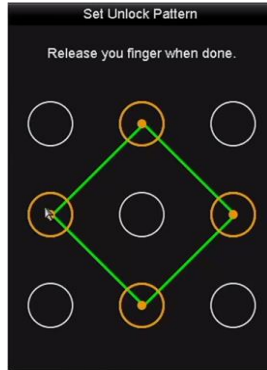

Figure 3-4 Draw the Pattern

 **NOTE**

- Connect at least 4 dots to draw the pattern.
- Each dot can be connected for once only.

Step 2 Draw the same pattern again to confirm it. When the two patterns match, the pattern is configured successfully.

Step 3 You can use the configured unlock pattern for future login.

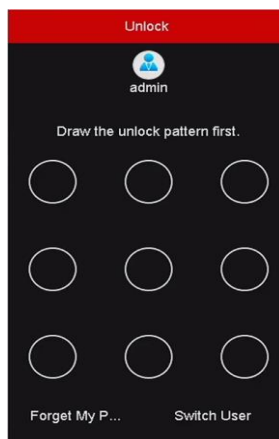

Figure 3-5 Draw the Unlock Pattern



## 3.4 User Login

**Purpose:**

If NVR has logged out, you must login the device before operating the menu and other functions.

Step 1 Select the **User Name** in the dropdown list.



Figure 3-6 Login

Step 2 Input Password.

Step 3 Click **OK**.



**NOTE**

In the Login dialog box, if you enter the wrong password 7 times, the current user account will be locked for 60 seconds.

## 3.5 Using the Setup Wizard

The Setup Wizard can guide you to configure the system resolution, system date/time, HDD initialization, IP camera management, etc.

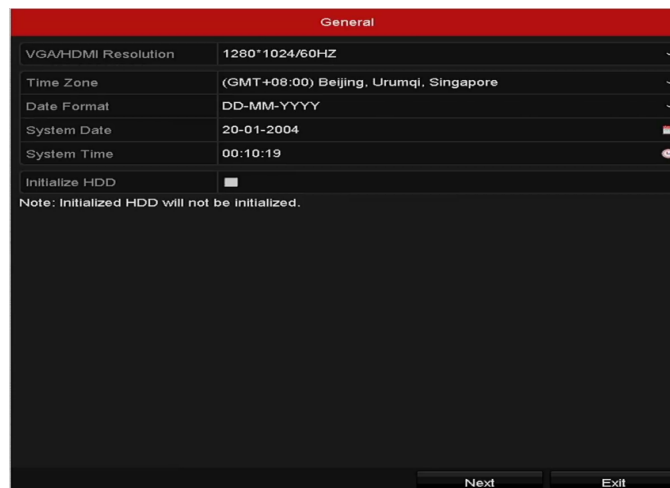

Figure 3-7 Wizard

## 3.6 Network Settings

**Purpose:**

Network settings must be properly configured before you operate NVR over network.

Step 1 Enter the general network settings interface.

Menu > Configuration > Network > General

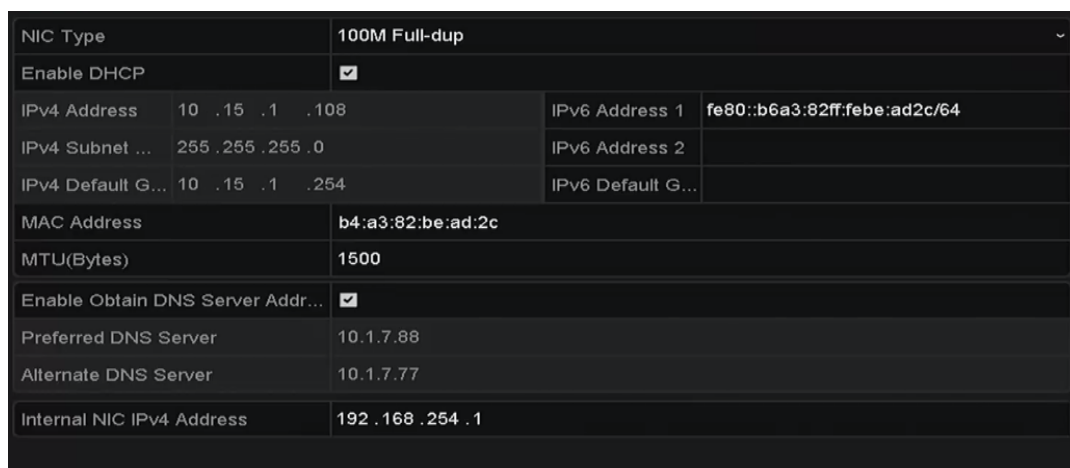

Figure 3-8 Network Settings

Step 2 Configure the following settings: NIC Type, IPv4 Address, IPv4 Gateway, MTU and DNS Server.

Step 3 If the DHCP server is available, you can check the checkbox of **DHCP** to automatically obtain an IP address and other network settings from that server.

Step 4 Click **Apply**.

## 3.7 Adding IP Cameras

**Purpose:**

Before you can get live video or record the video files, you should add the network cameras to the connection list of the device.

**Before you start:**

Ensure the network connection is valid and correct, and the IP camera to add has already been activated. Please refer to the *User Manual* for activating the inactive IP camera.

You can select one of the following three options to add the IP camera.

- **OPTION 1:**

Step 1 Click to select an idle window in the live view mode.

Step 2 Click  in the center of the window to pop up the Add IP Camera interface.



Figure 3-9 Add IP Camera

Step 3 Select the detected IP camera and click **Add** to add it directly, and you can click **Search** to refresh the online IP camera manually.

Or you can choose to custom add the IP camera by editing the parameters in the corresponding text field and then click **Add** to add it.

### 3.8 Live View

Icons are provided on screen in Live View mode to indicate camera status. These icons include:

#### Live View Icons

In the live view mode, there are icons at the upper-right corner of the screen for each channel, showing the status of the record and alarm in the channel for quick reference.



Alarm (video loss, tampering, motion detection, VCA or sensor alarm)



Record (manual record, continuous record, motion detection, VCA or alarm triggered record)

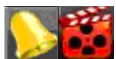

Alarm and Record



Event/Exception (event and exception information, appears at the lower-left corner of the screen.)

### 3.9 Recording Settings

#### **Before you start:**

Make sure that the disk has already been installed. If not, please install a disk and initialize it. You may refer to the user manual for detailed information.

**Purpose:**

Two kinds of record types are introduced in the following section, including Instant Record and All-day Record. And for other record types, you may refer to the user manual for detailed information.



**NOTE**

After rebooting all the manual records enabled are canceled.

Step 1 On the live view window, right lick the window and move the cursor to the **Start Recording** option, and select **Continuous Record** or **Motion Detection Record** on your demand.

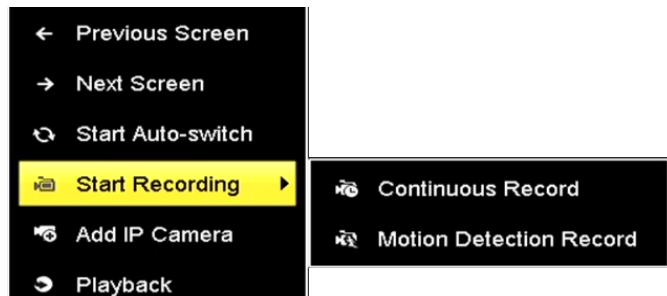

Figure 3-10 Start Recording from Right-click Menu

Step 2 Click **Yes** in the pop-up Attention message box to confirm the settings. All the channels will start to record in the selected mode.

### 3.10 Playback

The recorded video files on the hard disk can be played back in the following modes: instant playback, all-day playback for the specified channel, and playback by normal/event/smart/tag/sub-periods/external file search.

Step 1 Enter playback interface.

Click Menu > Playback or from the right-click menu

Step 2 Check the checkbox of channel(s) in the channel list and then double-click to select a date on the calendar.

Step 3 You can use the toolbar in the bottom part of Playback interface to control playing progress.

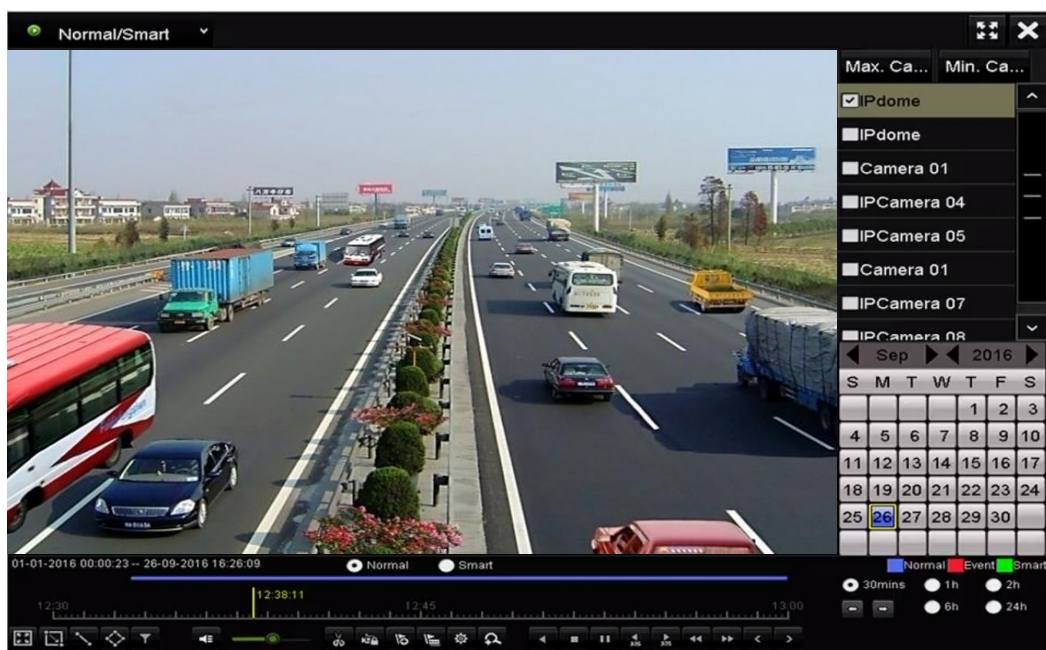

Figure 3-11 Playback Interface

Step 4 Select the channel(s) to or execute simultaneous playback of multiple channels.

## Chapter 4 Accessing by Web Browser

 **NOTE**

You shall acknowledge that the use of the product with Internet access might be under network security risks. For avoidance of any network attacks and information leakage, please strengthen your own protection. If the product does not work properly, please contact with your dealer or the nearest service center.

**Purpose:**

You can get access to the device via web browser. You may use one of the following listed web browsers: Internet Explorer 6.0, Internet Explorer 7.0, Internet Explorer 8.0, Internet Explorer 9.0, Internet Explorer 10.0, Internet Explorer 11.0, Apple Safari, Mozilla Firefox, and Google Chrome. The supported resolutions include 1024\*768 and above.

Step 1 Open web browser, input the IP address of the device and then press Enter.

Step 2 Login to the device.

- If the device has not been activated, you need to activate the device first before login.

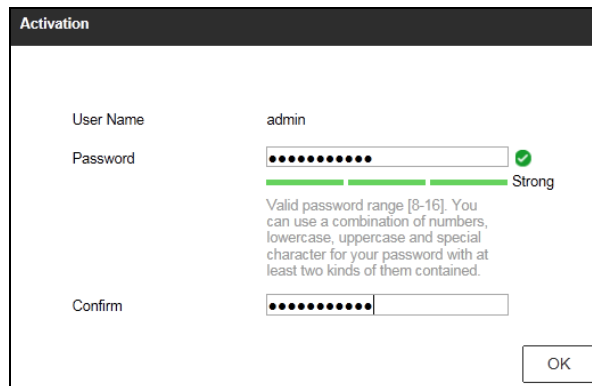

Figure 4-1 Set Admin Password

- 1) Set the password for the admin user account.
- 2) Click **OK**.

---

 **WARNING**

**STRONG PASSWORD RECOMMENDED**– We highly recommend you create a strong password of your own choosing (using a minimum of 8 characters, including upper case letters, lower case letters, numbers, and special characters) in order to increase the security of your product. And we recommend you reset your password regularly, especially in the high security system, resetting the password monthly or weekly can better protect your product.

---

- If the device is already activated, enter the user name and password in the login interface, and click **Login**.

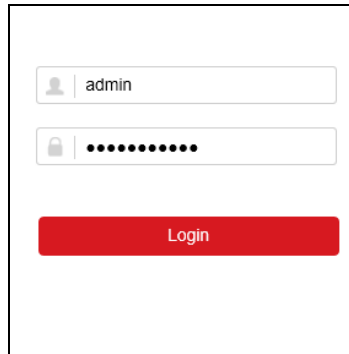

The screenshot shows a login form with two input fields and a button. The first field is for the username, containing the text 'admin'. The second field is for the password, represented by a series of black dots. Below the fields is a prominent red button labeled 'Login'.

Figure 4-2 Login

Step 3 Install the plug-in before viewing the live video and managing the camera. Please follow the installation prompts to install the plug-in.

 **NOTE**

You may have to close the web browser to finish the installation of the plug-in.

After login, you can perform the operation and configuration of the device, including the live view, playback, log search, configuration, etc.



See Far, Go Further