

VIVOTEK

A Delta Group Company

NR9581-V3 Recording Server

User's Manual

Rack-mount Enclosure • 32-/128-channel Recording • 8 Hot-swap Drive Bays
RAID storage • Full Integration with VIVOTEK Cameras

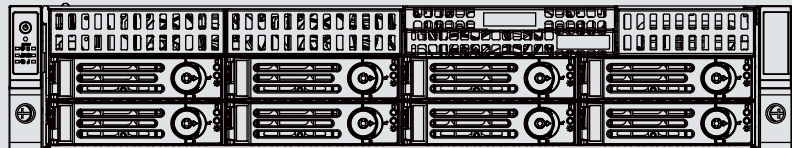

Rev. 1.1

Table of Contents

Revision History	4
Chapter 1: Hardware Installation and Initial Configuration	6
Introduction.....	6
Special Features	6
Safety.....	7
Installation Instructions	8
Power Supply.....	9
Environmental Specifications.....	9
Grounding Requirements.....	10
Physical Description	11
Drive Bay Numbering Sequence.....	11
Front View.....	11
Rear View	14
Display	15
Rack-mounting	16
Installing Hard Disk Drives	20
Connecting Interfaces	22
Initial Configuration.....	22
RAID Basics	37
Log in.....	63
Introducing VSS	64
Installing VSS	66
Installation Option.....	69
Chapter 1 Basics:	72
Control and Elements.....	72
Hot Keys	85
View Cell Elements	88
Server and Client Components	91
Chapter 2: Starting Up	93
2-1. Selecting Devices.....	94
2-2. Recording Options	95
Seamless Recording.....	99
Activity Adaptive Stream	101
2-3. Storage.....	102
Adding NAS (Network Attached Storage) as a Storage Option	103
2-4. Starting Up - Main Page.....	106
2-5. Customizable Layout.....	109
2-6. Saving a View	111
2-7. Add More Live Views.....	112
2-8. Tour	114
2-9. Save Your Preferences	116
2-10. Playback.....	117
2-11. PTZ Control	125

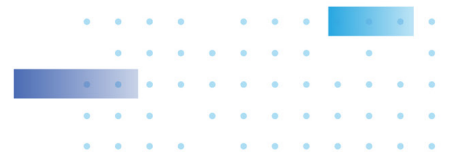

2-12. Fisheye Camera Dewarp Modes.....	128
2-13 Alarm.....	135
Group Alarm.....	149
2-14. E-Map.....	153
Placing DI/DO Devices	156
Uploading Substation E-map to CMS	157
Configuring GIS or Google Map and GPS.....	158
2-15. Dashboard.....	164
2-16. Search Panel.....	167
2-17. Event Search.....	169
2-18. Thumbnail Search	172
2-19. Smart Search	174
2-20. Deep Search	184
Chapter 3: Applications:	194
3-1. I/O DI/DO Devices.....	194
IO Box and Related Configuration	194
Configuring I/O Box DI/DO as a Trigger or Action in Alarm	196
3-2. Configuring Redundant Servers - Failover.....	200
Failover Configuration Process	207
3-3. Counting Report.....	211
3-4. VSS Software License	224
3-5. Managed PoE Switch.....	232
Chapter 4: Settings	237
4-1. Settings > System > Preferences.....	237
4-2. Settings > Device > Cameras	246
Streaming URL	247
4-3. Logical Folders.....	249
4-4. Settings > Recording > Recording Options.....	252
4-5. Settings > Recording > Backup	254
Storage.....	257
Mobile NVR Wi-Fi Backup (BETA)	258
4-6. Settings > Device > Stations	260
Multicasting	263
4-7. Settings > Recording > Local DB	267
4-8. Settings > System > SMTP	271
4-9. Settings > IO Box and Related Configuration	271
4-10. Settings > User Management.....	272
4-11. Settings > VIVOCloud	277
Appendix A: VSS Service Control Tool.....	281
Appendix B: Matrix	282
Appendix C: Joystick Support	287
Appendix D: Network Audio Solution	293
Appendix E: Upload Device Pack	298
Appendix F: Using LPR Related Functions w/ Data Magnet.....	300
Appendix G: Multi-factor Authentication for Access Control.....	316
Appendix H: Troubleshooting - Beep Sounds	323



Revision History

Rev. 1.0: Initial release.

Rev. 1.1: Update VSS 1.1. to 1.2.

WARNING:

1. Do not format or initialize the **Disk 0:** drive on your NVR. The **Disk 0:** drive contains the operating system. Doing so will disable the system.
2. No storage system is completely fail-safe. Damage to data might occur due to file system corruption, operating system malfunction, virus infection, HDD component failures, and so on. Therefore, it is highly recommended to regularly back up your data, and VIVOTEK disclaims responsibilities of data loss or recovery.
3. Always power off the system using the power down button on system desktop. Do not disconnect the power cord while the system is still operating. Doing so will result in data inconsistencies. The normal power-off procedure allows cached data to be written to disks.

Technology License Notice



Notices from HEVC Advance:

THIS PRODUCT IS SOLD WITH A LIMITED LICENSE AND IS AUTHORIZED TO BE USED ONLY IN CONNECTION WITH HEVC CONTENT THAT MEETS EACH OF THE THREE FOLLOWING QUALIFICATIONS: (1) HEVC CONTENT ONLY FOR PERSONAL USE; (2) HEVC CONTENT THAT IS NOT OFFERED FOR SALE; AND (3) HEVC CONTENT THAT IS CREATED BY THE OWNER OF THE PRODUCT. THIS PRODUCT MAY NOT BE USED IN CONNECTION WITH HEVC ENCODED CONTENT CREATED BY A THIRD PARTY, WHICH THE USER HAS ORDERED OR PURCHASED FROM A THIRD PARTY, UNLESS THE USER IS SEPARATELY GRANTED RIGHTS TO USE THE PRODUCT WITH SUCH CONTENT BY A LICENSED SELLER OF THE CONTENT. YOUR USE OF THIS PRODUCT IN CONNECTION WITH HEVC ENCODED CONTENT IS DEEMED ACCEPTANCE OF THE LIMITED AUTHORITY TO USE AS NOTED ABOVE.

セキュリティ基準（新規則第34条の10）

「本製品は 電気通信事業者（移動通信会社、固定通信会社、インターネットプロバイダ等）の通信回線（公衆無線 LAN を含む ）に直接接続することができません。本製品をインターネットに接続する場合は、必ずルータ等を経由し接続してください。」



Read Before Use

The use of surveillance devices may be prohibited by law in your country. The Network Camera is not only a high-performance web-ready camera but can also be part of a flexible surveillance system. It is the user's responsibility to ensure that the operation of such devices is legal before installing this unit for its intended use.

It is important to first verify that all contents received are complete according to the Package Contents listed below. Take note of the warnings in the Quick Installation Guide before the Network Camera is installed; then carefully read and follow the instructions in the Installation chapter to avoid damage due to faulty assembly and installation. This also ensures the product is used properly as intended.

The Network Camera is a network device and its use should be straightforward for those who have basic networking knowledge. It is designed for various applications including video sharing, general security/surveillance, etc. The Configuration chapter suggests ways to best utilize the Network Camera and ensure proper operations. For creative and professional developers, the URL Commands of the Network Camera section serves as a helpful reference to customizing existing homepages or integrating with the current web server.



NOTE:

The operating system and management software are installed on a flash memory mounted on the main board. Except for the plug-ins for onscreen display, there is no need to install software.

Package Contents

- NR9581-V3
- Power cords
- Mouse
- Quick Installation Guide
- Screws and slide rails

Symbols and Statements in this Document



INFORMATION: provides important messages or advices that might help prevent inconvenient or problem situations.



NOTE: Notices provide guidance or advices that are related to the functional integrity of the machine.



Tips: Tips are useful information that helps enhance or facilitate an installation, function, or process.



WARNING! or IMPORTANT: These statements indicate situations that can be dangerous or hazardous to the machine or you.



Electrical Hazard: This statement appears when high voltage electrical hazards might occur to an operator.



Chapter 1: Hardware Installation and Initial Configuration

Introduction

NR9581-V3 is the latest 32-channel (expandable up to 128-channel) H.265, RAID-protected NVR from VIVOTEK, bringing stable and efficient system operation under a wide range of recording/network management/system settings. The unit supports all VIVOTEK camera models, including the latest 5-Megapixel and fisheye cameras. The support for RAID 1/5/6/10 provides data security in the event of disk drive failure.

The unit is equipped with two 2.5 Gigabit Ethernet RJ45 ports which provide network failover functionality to avoid the risk of recording loss. When one network line is disconnected, the system will shift to the other network automatically, providing continuous access for video data. Up to 16 HDDs can be installed in the NR9581-V3. The hot-swappable HDD trays are available in the front of the unit, with hot-swap functionality for easy replacement.

A VSS CMS server runs on the machine that manages surveillance recording and playback. The compatibility with the iViewer application allows for remote access to the NR9581-V3 on handheld devices. By integrating all of the components together using VIVOTEK's NVR, network cameras, VSS, and iViewer software, users can realize a fully-featured and robust next-generation surveillance system. This ingenious NVR also features the remote management capability with a full range of server/client structures and thus is capable for robust and diverse applications.

Special Features

- Runs on embedded Windows
- 2U Rack Mount Design
- RAID 0, 1, 5, 6, 10, 50, 60 in virtual drive storage configurations
- 8 x HDD Tray.
- 2 x 2.5 Gigabit RJ45 Ethernet ports
- Front: USB2.0 x 2, COM x 1
- Back: USB2.0 x 2, USB3.2 x 4 (USB Type-C x 2, rating 1.5A)
- Size: 89 (H) x 437 (W) x 647 (D) mm
- 128-CH Live View & 16-CH Synchronous Playback
- H.265/H.264/ MJPEG
- PTZ Support
- Snapshot / Export Media
- PiP Video Control
- Bookmark Design
- Fast Configuration Backup / Restore
- Pre-installed VIVOTEK VSS Central Management Software*
- Full Integration with VIVOTEK Network Cameras
- VIVOTEK iViewer Support (iOS/Android)



Safety

1. Ensure that all maintenance and repair work is handled by qualified personnel such as electrical engineers or network specialists.
2. Read these safety instructions carefully.
3. Keep this User Manual for later reference.
4. Disconnect this equipment from any AC outlet before cleaning. Use a damp cloth. Do not use liquid or spray detergents for cleaning.
5. For plug-in equipment, the power outlet socket must be located near the equipment and must be easily accessible.
6. Keep this equipment away from humidity.
7. Put this equipment on a reliable surface during installation. Dropping it or letting it fall may cause damage.
8. For rack-mount equipment, please firmly install the device with pallets or sliding rails in the rack.
9. Do not leave this equipment in an environment unconditioned where the storage temperature under 0° C (32° F) or above 40° C (104° F), it may damage the equipment.
10. The openings on the enclosure are for air convection. Protect the equipment from overheating. **DO NOT COVER THE OPENINGS.**
11. Make sure the voltage of the power source is correct before connecting the equipment to the power outlet.
12. Position the power cord so that people cannot step on it. Do not place anything over the power cord.
13. All cautions and warnings on the equipment should be noted.
14. If the equipment is not used for a long time, disconnect it from the power source to avoid damage by transient overvoltage.
15. Never pour any liquid into an opening. This may cause fire or electrical shock.
16. Never open the equipment. For safety reasons, the equipment should be opened only by qualified service personnel.
17. If one of the following situations arises, get the equipment checked by service personnel:
 - The power cord or plug is damaged.
 - Liquid has penetrated into the equipment.
 - The equipment has been exposed to moisture.
 - The equipment does not work well, or you cannot get it to work according to the user's manual.
 - The equipment has been dropped and damaged.
 - The equipment has obvious signs of breakage.
18. **CAUTION:** The computer is provided with a battery-powered real-time clock circuit. There is a danger of explosion if battery is incorrectly replaced. Replace only with same or equivalent type recommended by the manufacturer. Discard used batteries according to the manufacturer's instructions.
19. **This device complies with Part 15 of the FCC rules. Operation is subject to the following two conditions: (1) this device may not cause harmful interference, and (2) this device must accept any interference received, including interference that may cause undesired operation.**



20. **CAUTION:** Always completely disconnect the power cord from your chassis whenever you work with the hardware. Do not make connections while the power is on. Sensitive electronic components can be damaged by sudden power surges.
21. **CAUTION:** Always ground yourself to remove any static charge before touching the motherboard, backplane, or add-on cards. Modern electronic devices are very sensitive to static electric charges. As a safety precaution, use a grounding wrist strap at all times. Place all electronic components on a static-dissipative surface or in a static-shielded bag when they are not in the chassis.
22. **CAUTION:** Any unverified component could cause unexpected damage. To ensure the correct installation, please always use the components (e.g., screws) provided with the accessory box.

Installation Instructions



Warning:

Do not alter the hardware configuration by installing, replacing, or upgrading hardware components. Doing so will void our warranty.



Warning:

Read the installation instructions before connecting the system to the power source.



Warning:

This product relies on the building's installation for short-circuit (overcurrent) protection. Ensure that the protective device is rated not greater than: 250V, 20 A.



Warning:

The system must be disconnected from all sources of power and the power cord removed from the power supply module(s) before accessing the chassis interior to install or remove system components.



Warning:

Only trained and qualified personnel should be allowed to install, replace, or service this equipment.



Warning:

This unit is intended for installation in restricted access areas. A restricted access area can be accessed only through the use of a special tool, lock and key, or other means of security. (This warning does not apply to workstations). The access can only be gained by Skilled person or by Instructed person. Only authorized by well trained professional person can access the restrict access location.



Warning:

There is the danger of explosion if the battery is replaced incorrectly. Replace the battery only with the same or equivalent type recommended by the manufacturer. Dispose of used batteries according to the manufacturer's instructions.



CAUTION:

This unit has redundant power sources. Please disconnect all the power cords before servicing.





Warning:

Hazardous voltage or energy is present on the backplane when the system is operating. Use caution when servicing.



Warning:

Installation of the equipment must comply with local and national electrical codes.



Warning:

Ultimate disposal of this product should be handled according to all national laws and regulations.



Warning:

The fans might still be turning when you remove the fan assembly from the chassis. Keep fingers, screwdrivers, and other objects away from the openings in the fan assembly's housing.



Warning:

When installing the product, use the provided or designated connection cables, power cables and AC adaptors. Using any other cables and adaptors could cause a malfunction or a fire. Electrical Appliance and Material Safety Law prohibits the use of UL or CSA -certified cables (that have UL/CSA shown on the code) for any other electrical devices than products designated by the manufacturer only.



IMPORTANT:

Some low quality Ethernet cables with smaller core diameter can seriously reduce the transmission rate. Use CAT5e or CAT6 cables with a wire gauge of 24AWG for NVR's uplink port. A thicker core 24 AWG network cable can offer less resistance than a 26 AWG or 28 AWG network cable.

Use shielded cables in high noise environments where cross talk and EMI can occur.

Power Supply

Watt	550W max. (80+ Gold, PFC) (1+1 Redundant 2U)
Input rating	100-240Vac, 7.0A-3.5A, 50-60Hz
Output voltage	+12.V/45.8A, +12Vsb/3.0A, total output power: max. 550W
Minimum load	+12V @ 0.5 A
Safety	UL/TUV/CCC

Environmental Specifications

Environment	Operating
Temperature	5 ~ 35°C (41 ~95°F)
Humidity	5 ~ 95%
Safety	CE, FCC, VCCI, C-Tick, UL, CB, BSMI, BIS



Grounding Requirements

1. The enclosure is designed to be rack-mounted, in an equipment room which has limited human access.
2. In addition to the grounding via the power cords, make sure your equipment rack is properly grounded. If the equipment rack is not properly grounded, connect the ground wire to a grounding bus bar, which is then connected to an earth ground.
3. Use a green and yellow ground wire of a copper cross section of at least 16AWG.
4. Connect the system to an earthed main power outlet.

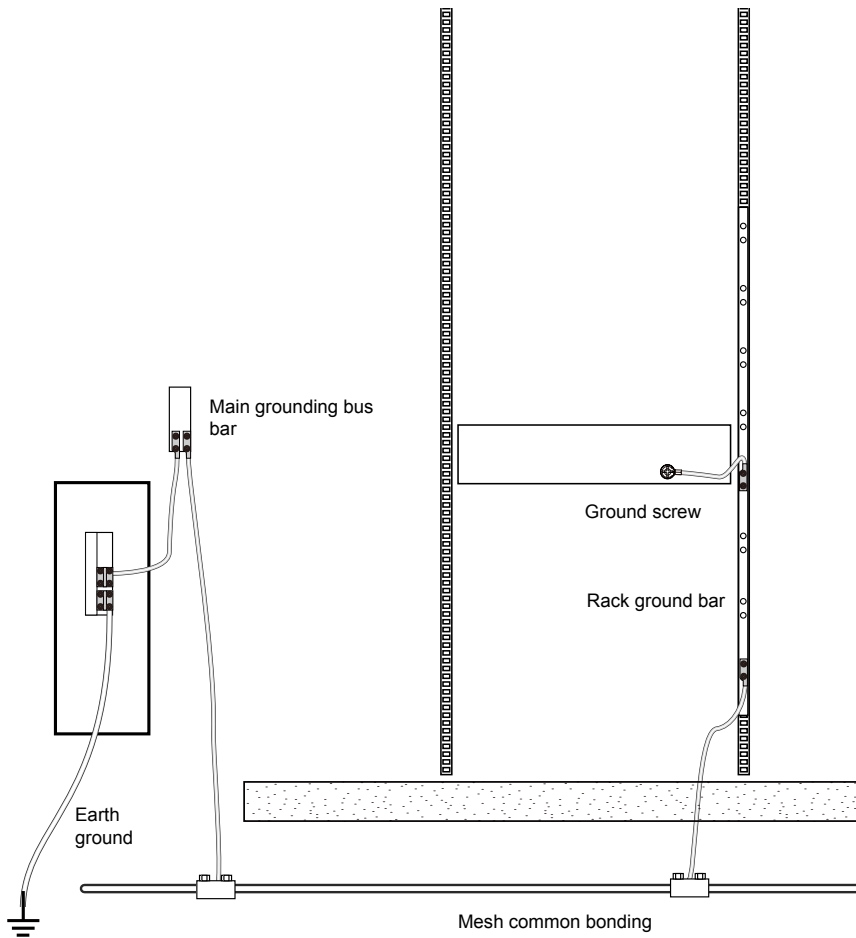

Physical Description

● Front View

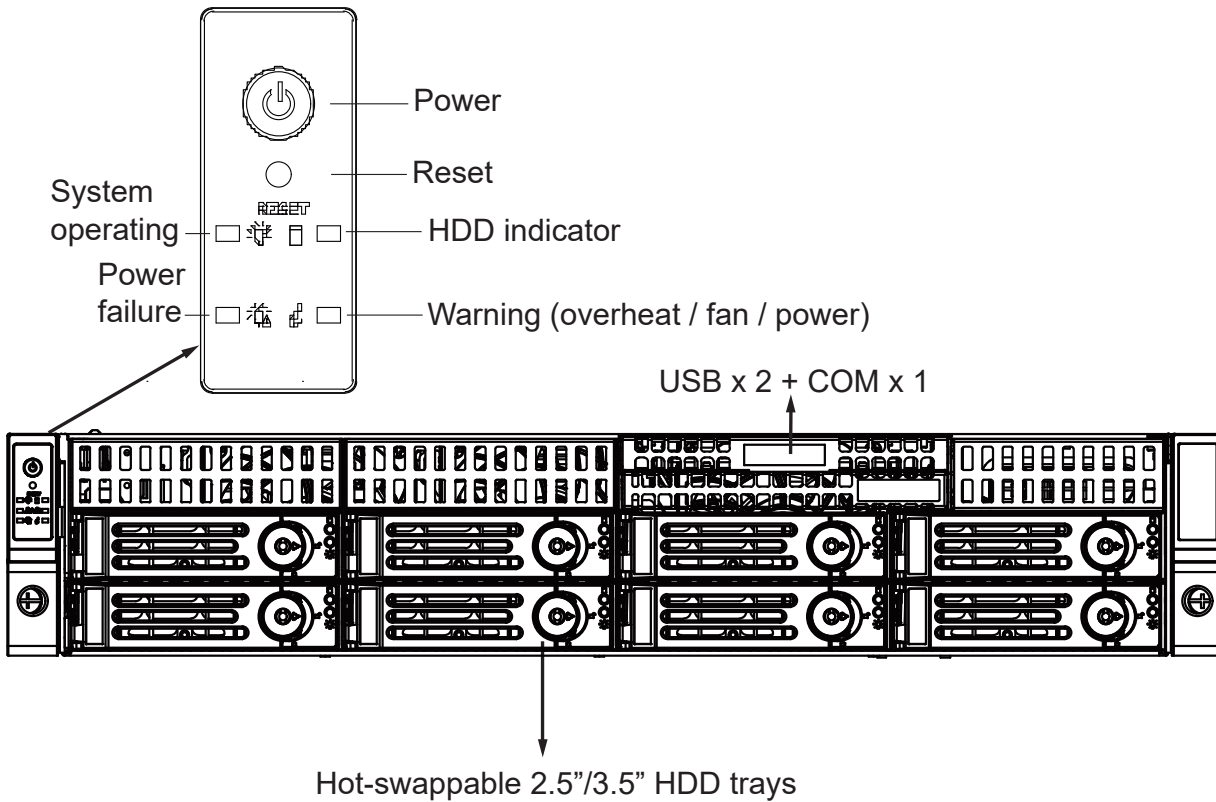

Drive Bay Numbering Sequence

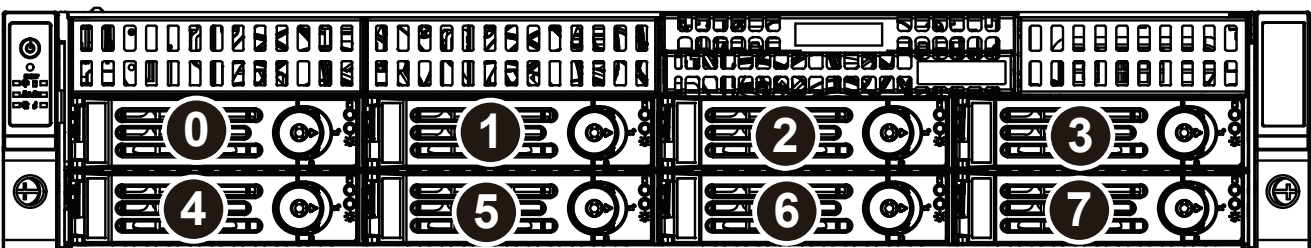

Warning:

Knowing the correct positions of hard drives is very important. For example, if a hard drive fails in a RAID5 Virtual Drive, you can initialize a rebuild by locating and replacing the failed drive. If you replace the wrong drive, it means that you have 1 failed drive and another mistakenly failed drive. Having 2 failed drives in a RAID5 configuration renders all data inaccessible. All data in the RAID5 Virtual Drive will be lost.





Control Panel buttons and LEDs		
	Power switch	<p>Press this switch to turn the system power on or off. Please use system shutdown or press this switch for a few seconds to turn off the system ATX power.</p> <p>The main power switch is used to apply or remove power from the power supplies to the server. Turning off system power using this button removes the main power but keeps standby power supplied to the system. You must unplug the system before servicing components inside the chassis.</p>
	Reset button	Press this button to reboot the system.

Information LED	
Status	Description
Solid red	An overheat condition has occurred (possibly caused by cable congestion)
Blinking red (1Hz)	Fan failure, check for an inoperative fan.
Blinking red (0.25Hz)	Power supply failure
Solide blue	UID has been activated locally to locate the server in a rack environment.
Blinking blue	UID has been activated using IPMI to locate the server in a rack environment.



* The HDD LED here only displays the status for those attached to the motherboard. They do not display the status for the hard disks in the 16 drive bays

Front Hot-swappable Drive Tray LEDs		
	 Activity LED: Green	 Status LED: Amber
Drive not present	OFF	OFF
Drive present, no activity	ON	OFF
Drive present, activity	4Hz blinking	OFF
Locate (Identify)	OFF	4Hz blinking
Fail	OFF	ON
Rebuild	OFF	1Hz blinking



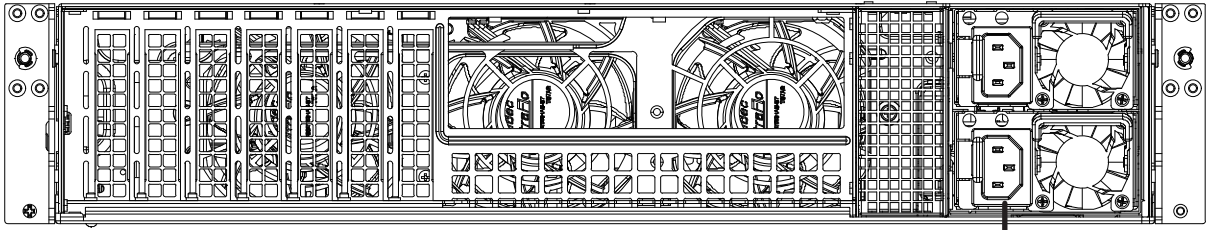

100-240Vac,
50/60Hz, 2.21-1.1A

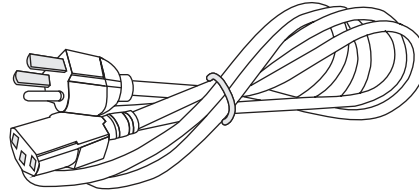
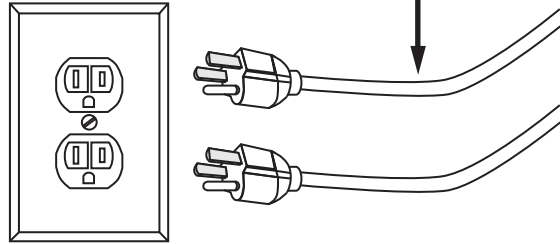

Display

Interface	Resolution
HDMI	Supports max resolution HDMI x 1 4096 x 2160
DVI	Supports max. resolution DVI x 1 1920 x 1200
Display port	Supports max resolution DP x1 7680 x 4320
eDP	Internal pin header, supports max. resolution 3840 x 2160 @ 60 Hz (on board)
VGA	VGA x 1, Max resolution 1920 x 1200
Triple display	eDP/ VGA + DP++ + HDMI, eDP/ VGA + HDMI + DVI-D, DP++ + eDP/ VGA + DVI-D, DVI-D + DP++ + HDMI
Dual display	DP++ + HDMI, DP++ + DVI-D, DP++ + eDP/ VGA, HDMI + DVI-D, HDMI + eDP/ VGA, eDP, VGA + DVI-D

⚠ IMPORTANT:

It is important to leave a clearance of 76cm to the rear side of the chassis. The clearance is required to ensure an adequate airflow through the chassis to ventilate heat. A 64cm clearance is also required on the front of the chassis.

To ensure normal operation, maintain ambient airflow. Do not block the airflow around chassis such as placing the system in a closed cabinet.

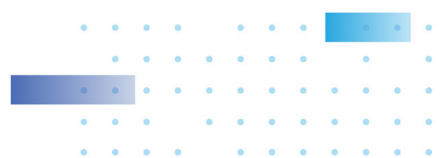
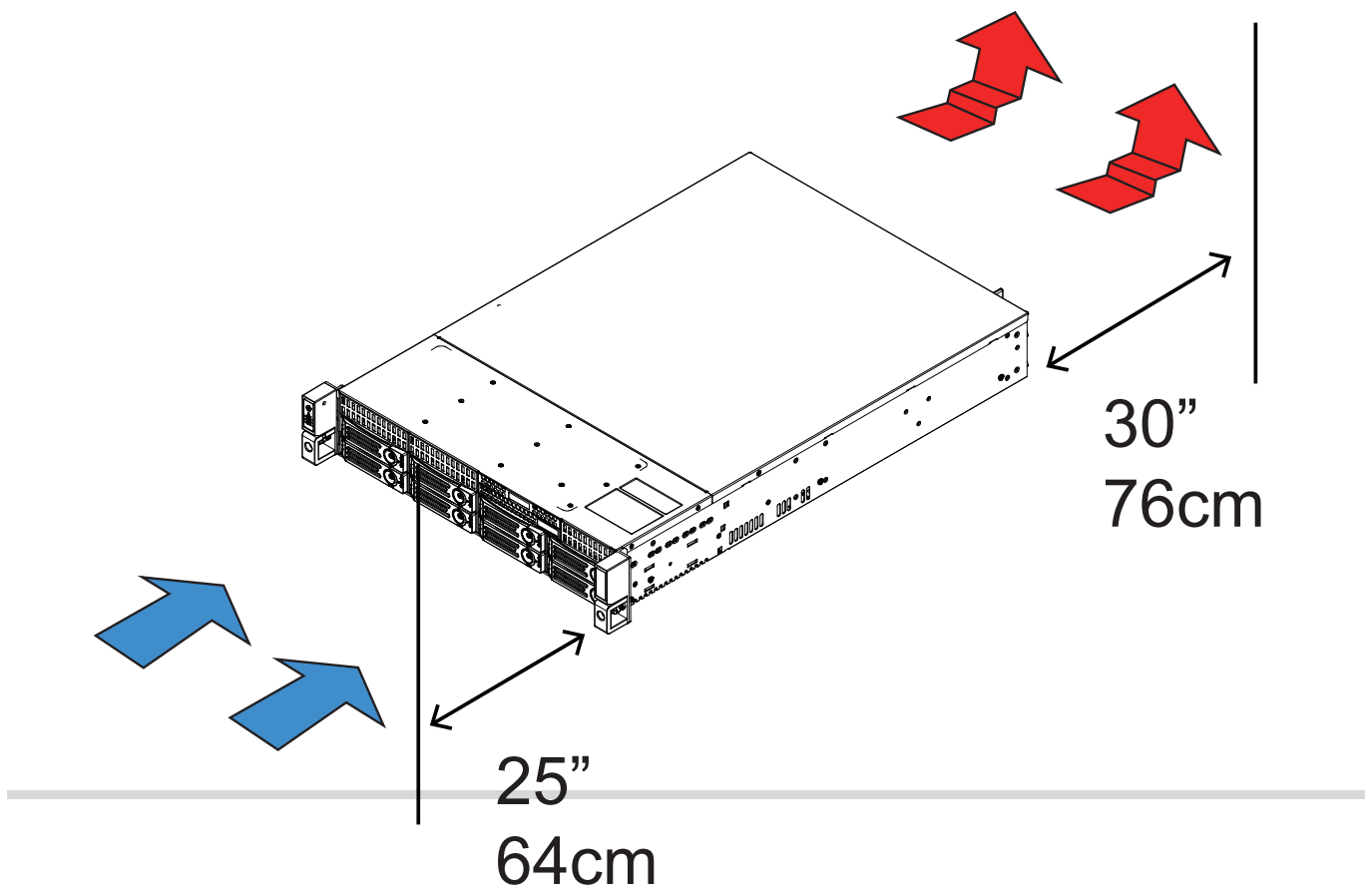

Rack-mounting



IMPORTANT:

If you have either a round-holed or square-holed rack, install cage nuts or clip nuts to the desired positions on the rack posts.

The instructions below are based on the installation to a 4-post equipment rack.

1. Remove the inner rail from the slide rail assembly.

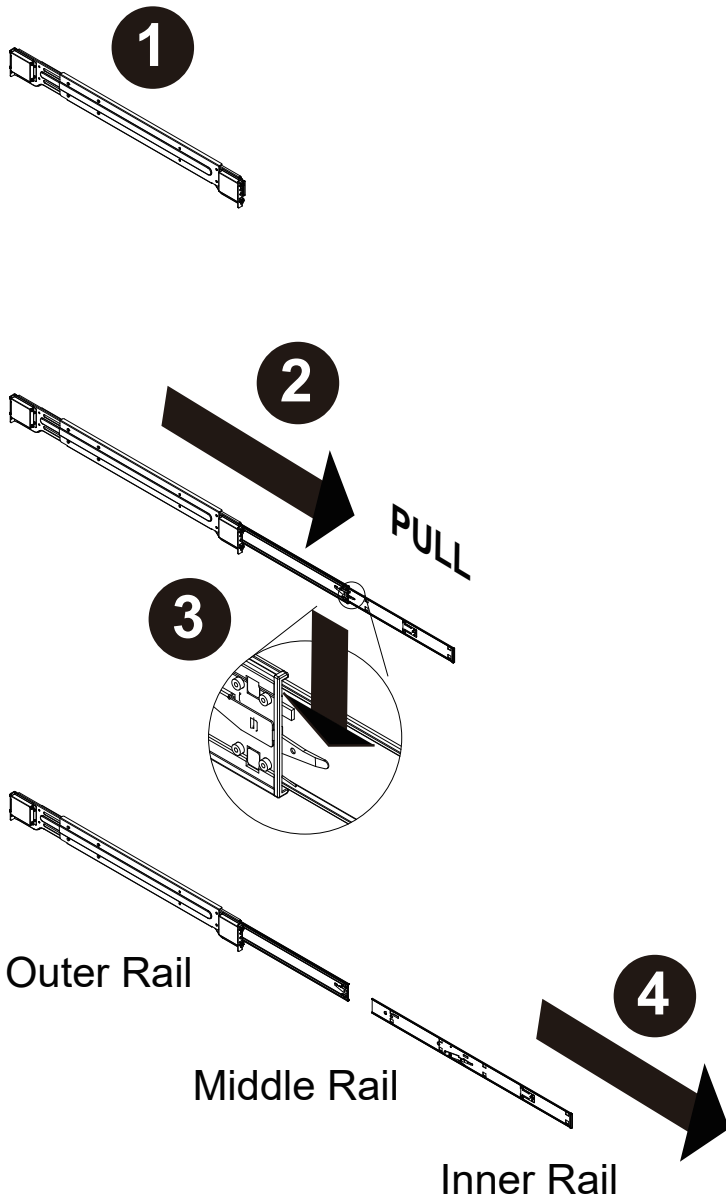

2. Secure the inner rails to the sides of the chassis using the included screws.

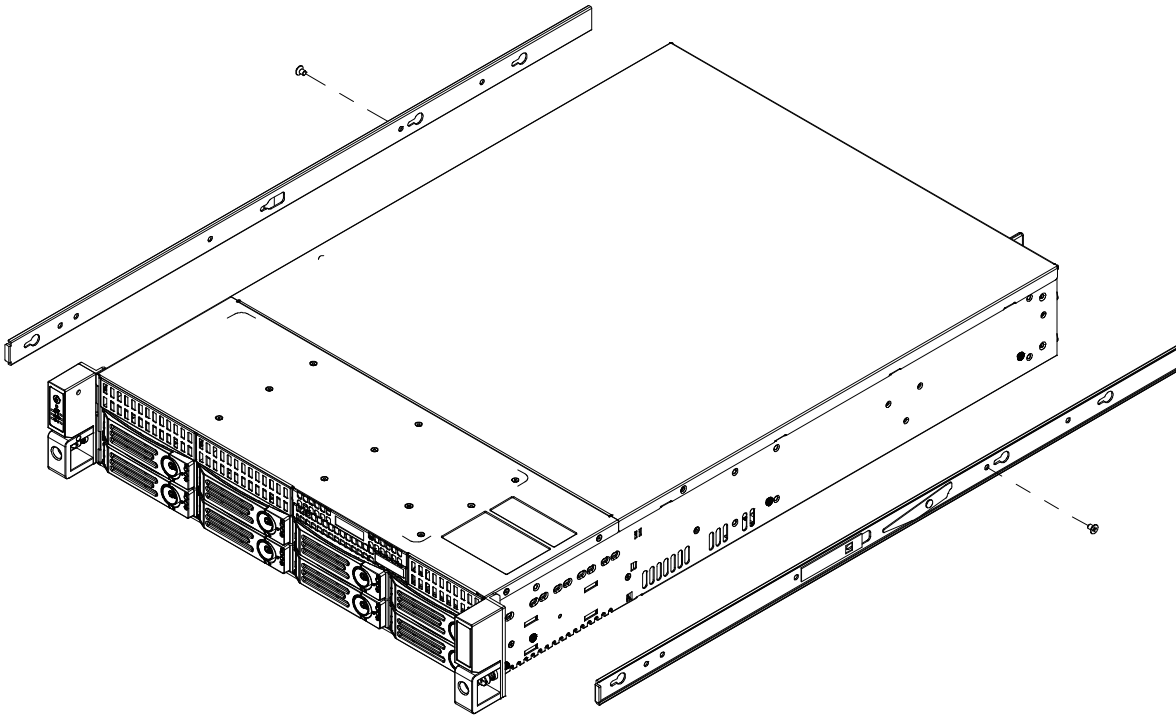

3. The middle and outer rail assemblies look like this.

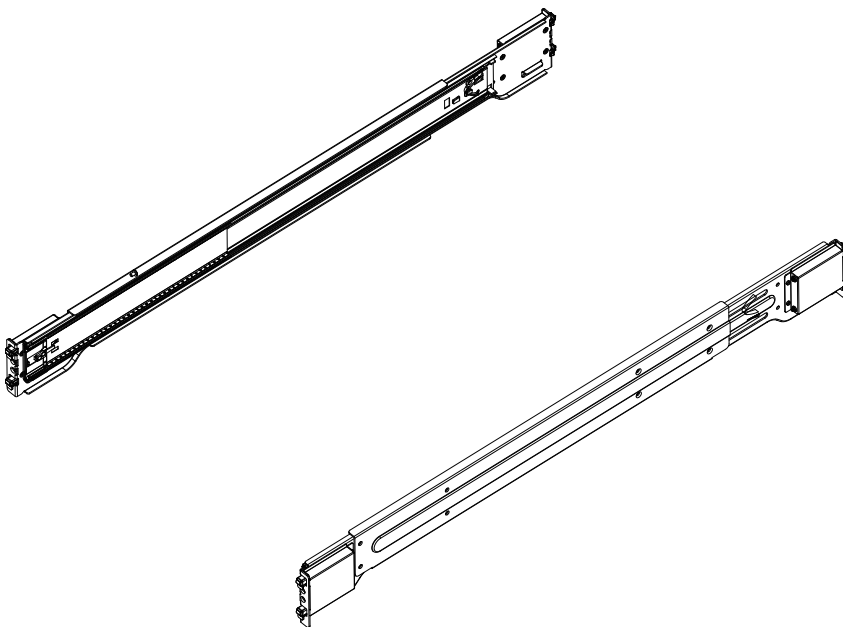

4. Attach the slide rails to the front rack post by hanging them to the rack holes. You may secure them with screws.

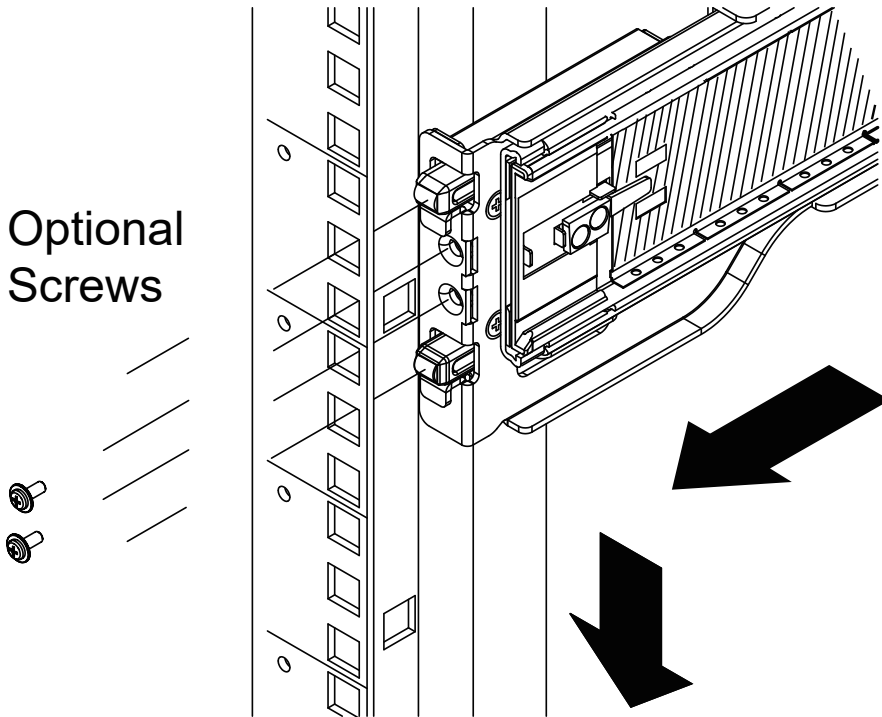

5. Extend the rails as necessary, and repeat the previous step to hang the slide rails to four rack posts.

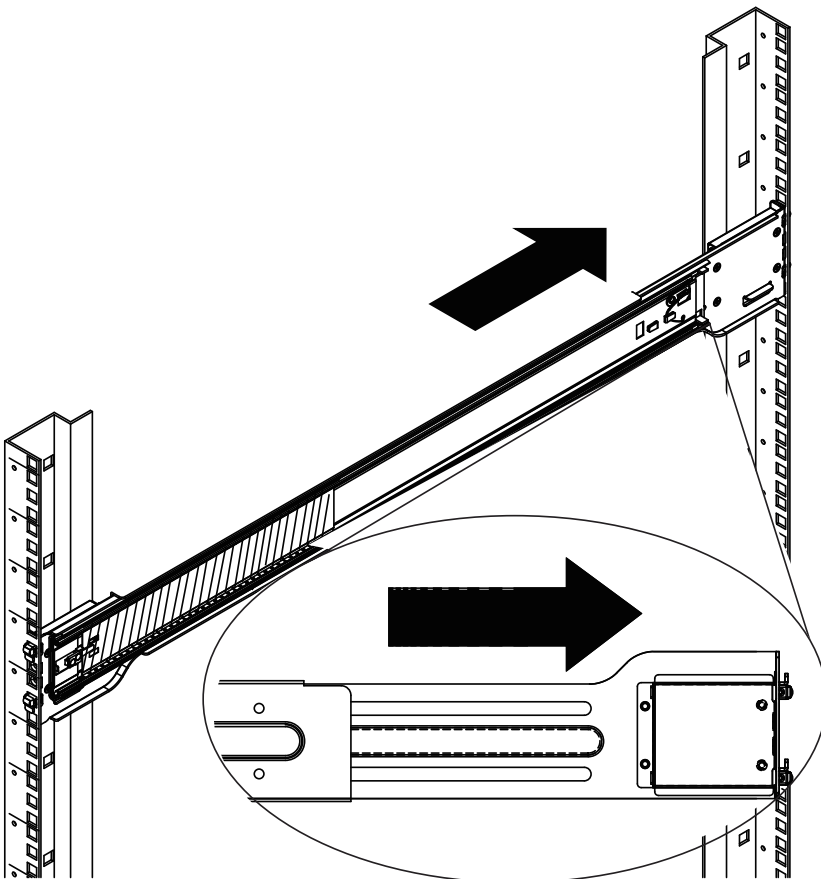

6. Pull the middle rail out of the front end, and make sure the ball bearing shuttle is locked at the front of the middle rail.

Align the tips of the inner rails with the middle rails, and then push the chassis until it clicks into the slide rails.

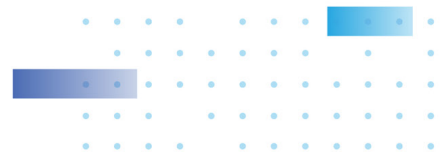
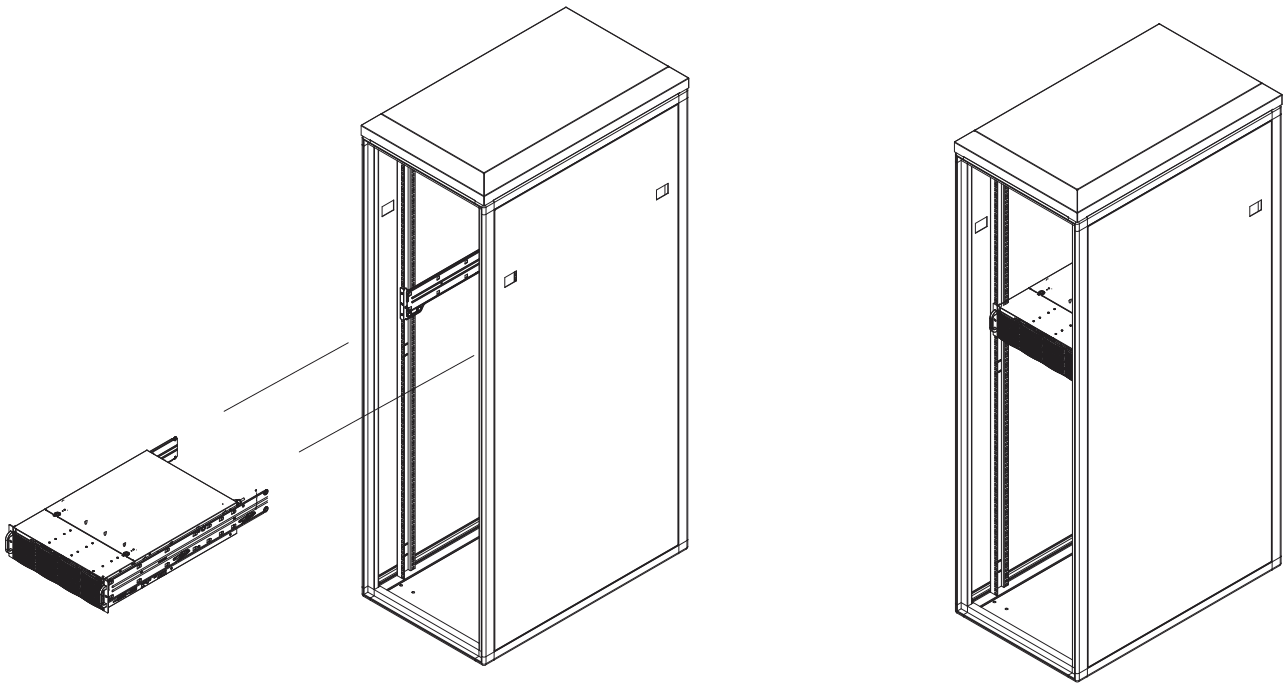

Installing Hard Disk Drives



IMPORTANT:

- Refer to VIVOTEK's website for the hard disk compatibility information.
- Avoid touching the hard drive's circuit board or connector pins. Doing so can damage the hard drive by electro-static discharge.

1. Remove drive trays from the chassis. Push the release tab to the side, the tray lever will pop out. Pull the lever to remove drive trays.

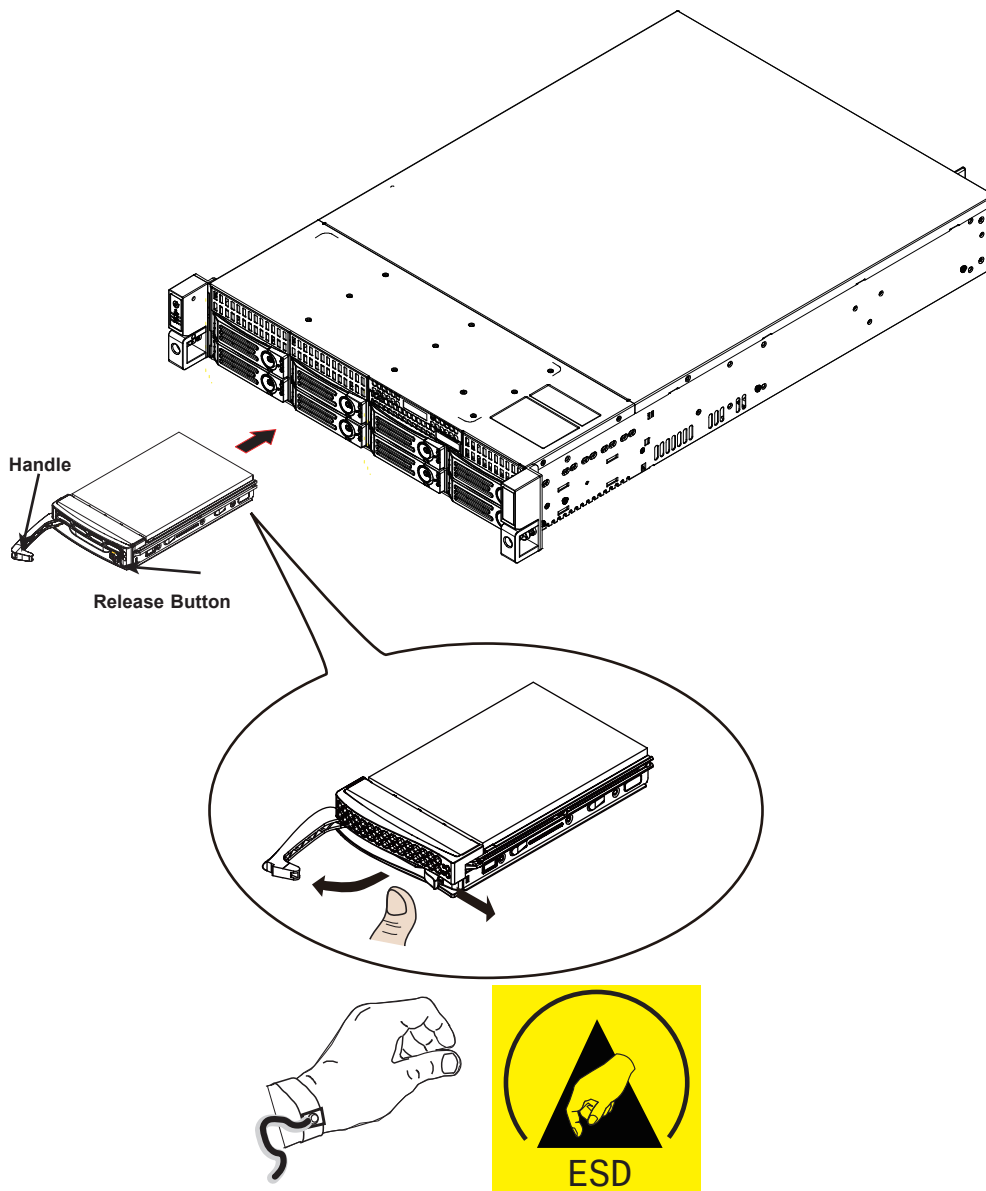

2. Use a Phillips screwdriver to remove screws from the side and then remove the plastic Dummy Drive.

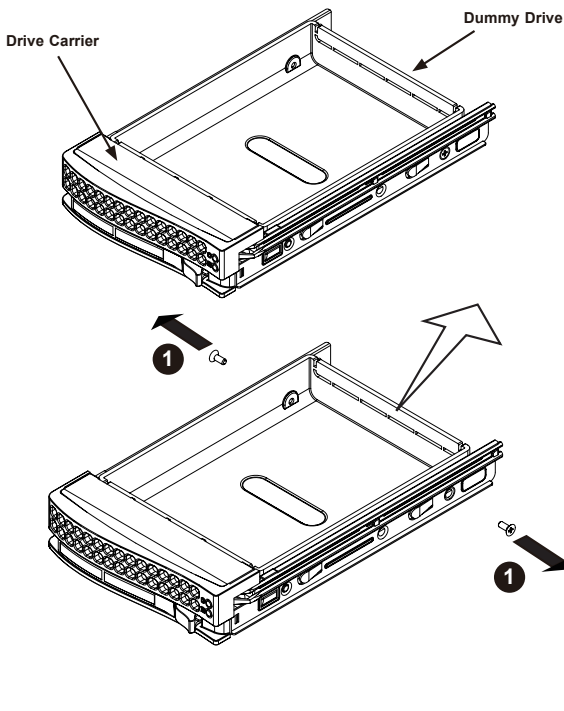

It is recommended to wear an anti-static wrist strap when handling hard drives.



3. Install hard drives by driving screws from the sides. When done, gently install the drive trays into the chassis.

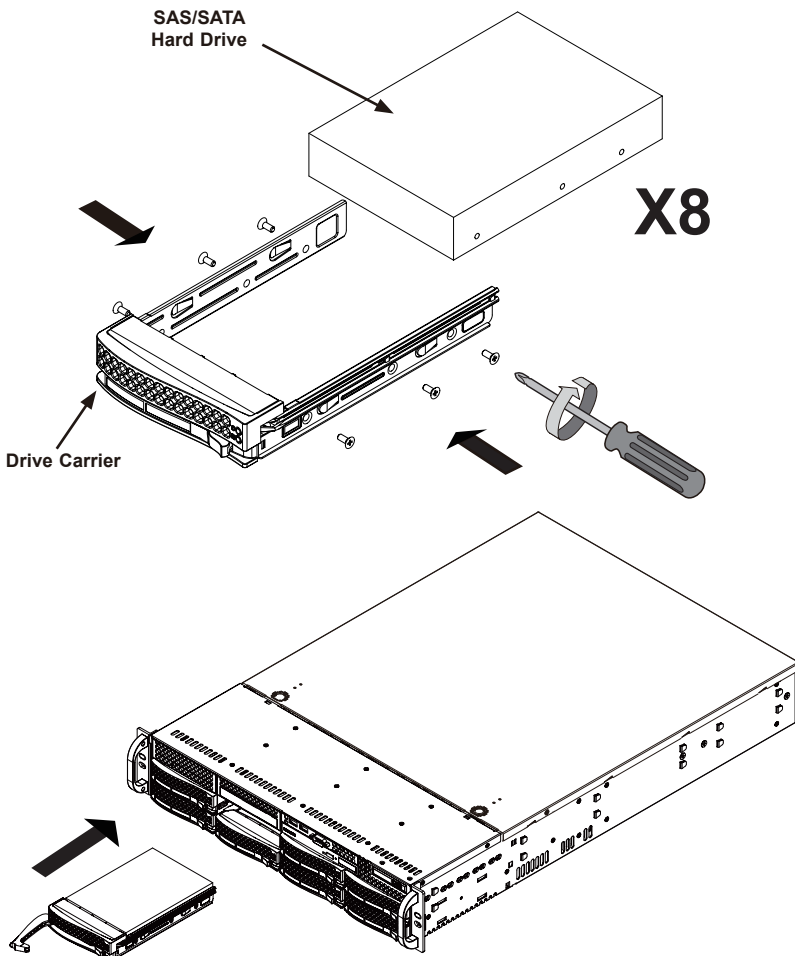

Connecting Interfaces

Refer to page 13 for the interface connections.

1. Make sure all cameras have been properly installed, either they are powered by 12V power lines or using one or several PoE switches or mid-spans. Refer to the cameras' documentation for details.
2. Connect all other interfaces to USB mouse/keyboard, one or two monitors, and audio input/output devices.
3. Make sure you connect both power supplies to power mains. An alarm will be sounded if you connect only 1 of the power supplies.

Initial Configuration

1. Power up the system by pressing the power on button.

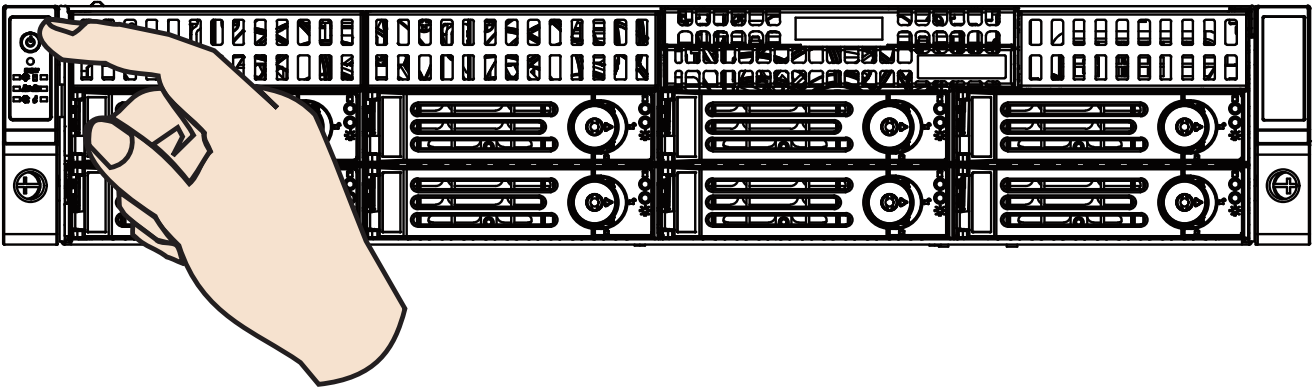

2. Skip the BIOS screens and select Enter NVR at the selection screen. The system will start. Wait for the start-up process to complete.

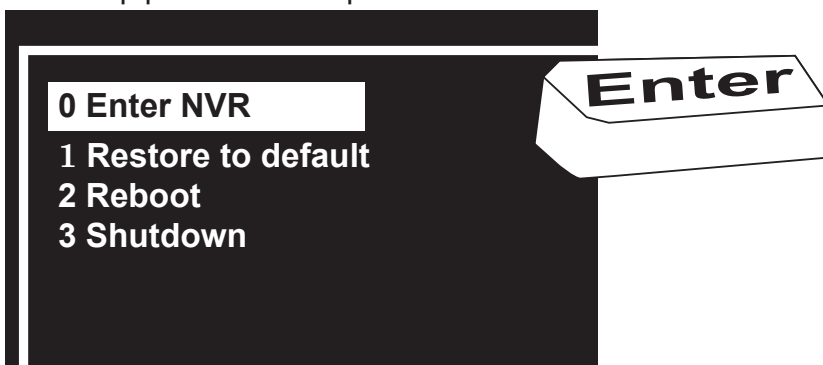

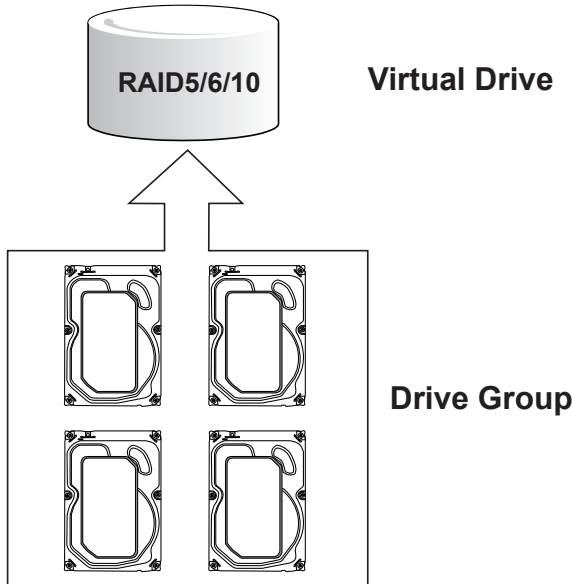

Our default recommendation is to combine 4 hard drives into 1 drive group. The capacities of these drives will be utilized to form 1 Virtual Drive. If all 8 drive bays are populated, you can create 2 Virtual Drives. A 4-member Virtual Drive can receive the video feeds from 32 to 128 cameras. You can also create one 8-member Virtual Drive to receive the video feeds from 32 to 128 cameras (CH, or channels.)

Recording will not take place unless you create a Virtual Drive first. Select RAID5 as the RAID level during the configuration process.

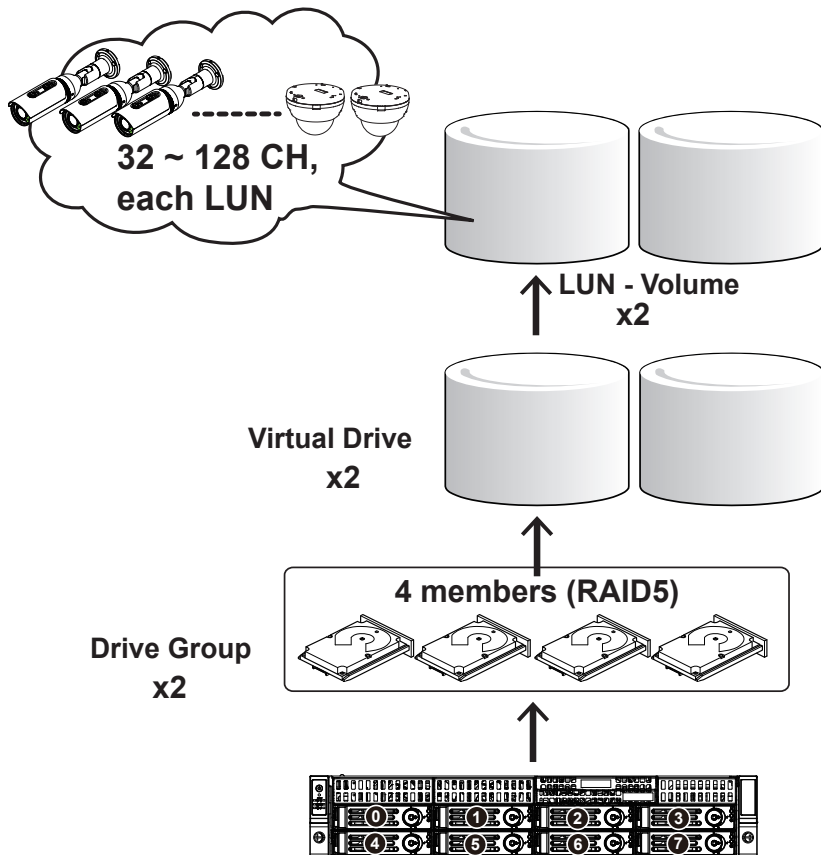

The default configuration for a configuration of 128 cameras should look like the following:

Physical & Logical components	Configuration
Hard drive	8
Virtual Drive	2, each has 4 members. Configured in RAID5. If using 6TB drives, the available capacity in each Virtual Drive will be, 4 x 6TB-1 x 6TB(parity drive)= 18TB.
Volume	2, each created from 1 Virtual Drive.

The camera configuration should look like this,

Physical & Logical components	Configuration
Cameras	128
Recording Group	2, each responds to 64 cameras, and each Recording Group is associated with 1 Virtual Drive volume.
Volume	2, each created from 1 Virtual Drive, and associated with 1 Recording Group. .

A Virtual Drive appears to the host system (Windows) as a logical disk partition. The logical partition, when formatted, becomes a disk volume.

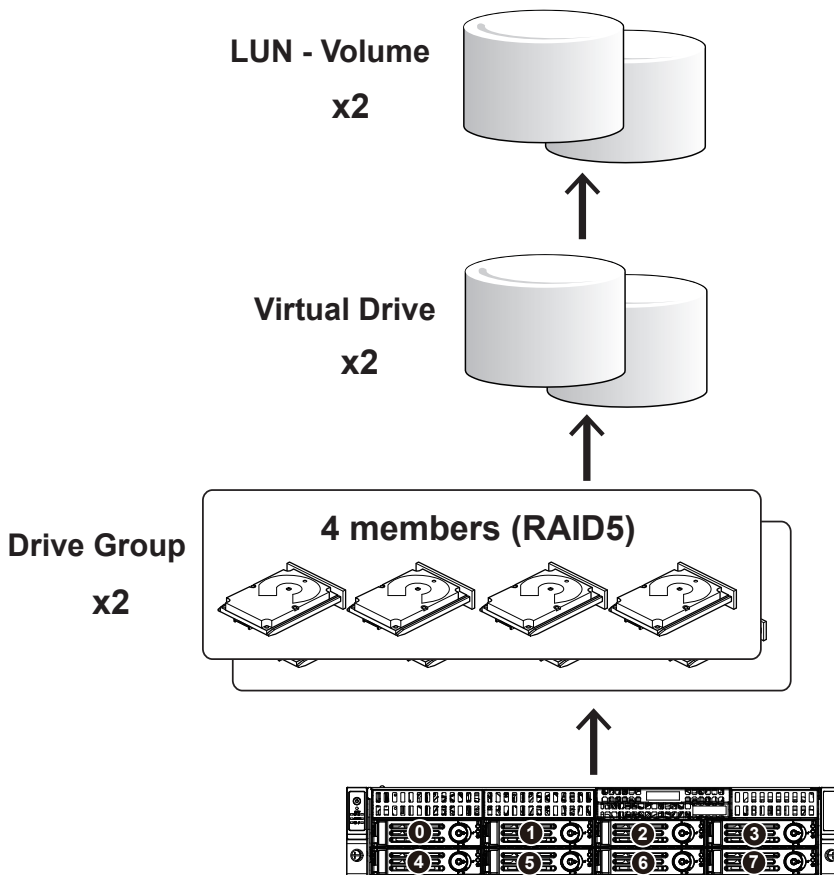

1. The system will boot up to the system main screen. Double-click on the RAID Config shortcut to start the MegaRAID storage configuration utility.

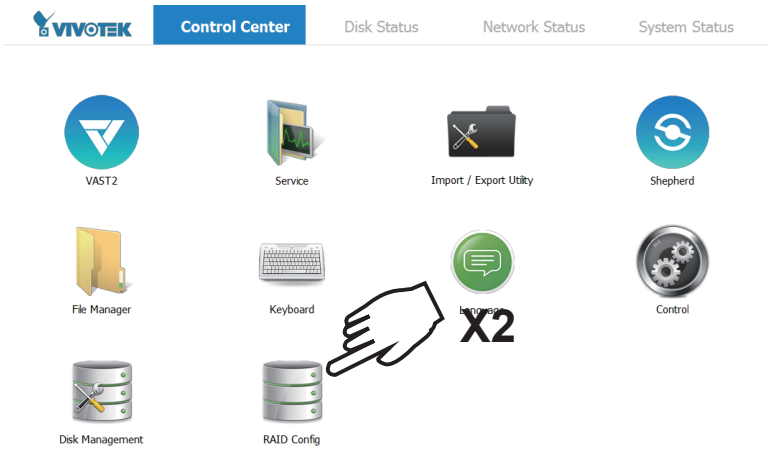

Start this utility 10 seconds after you install H.D.D.



Ctrl + Alt + F12 ->

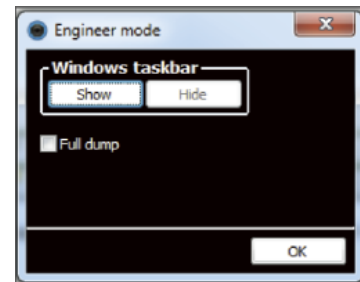

2. Enter vivotek/vivotek as the User Name and Password. Click Login to proceed.

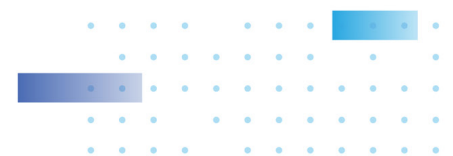
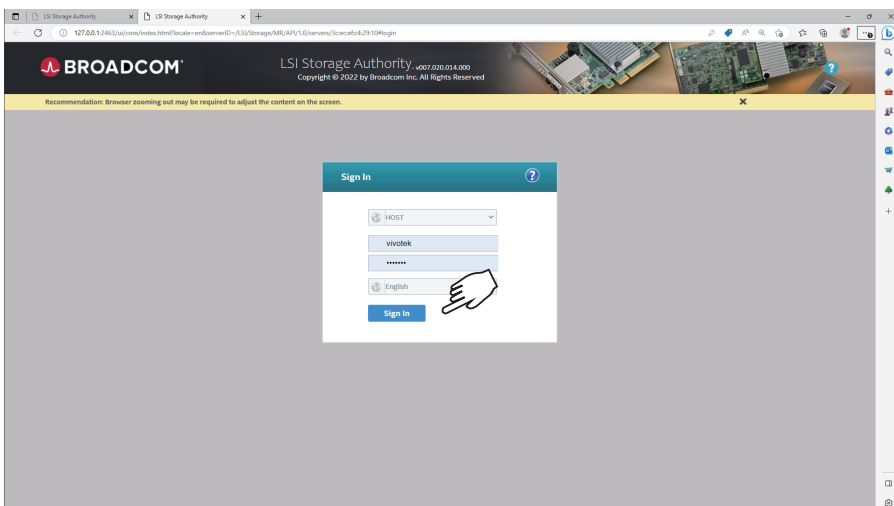

3. Select Configuration > Simple configuration.

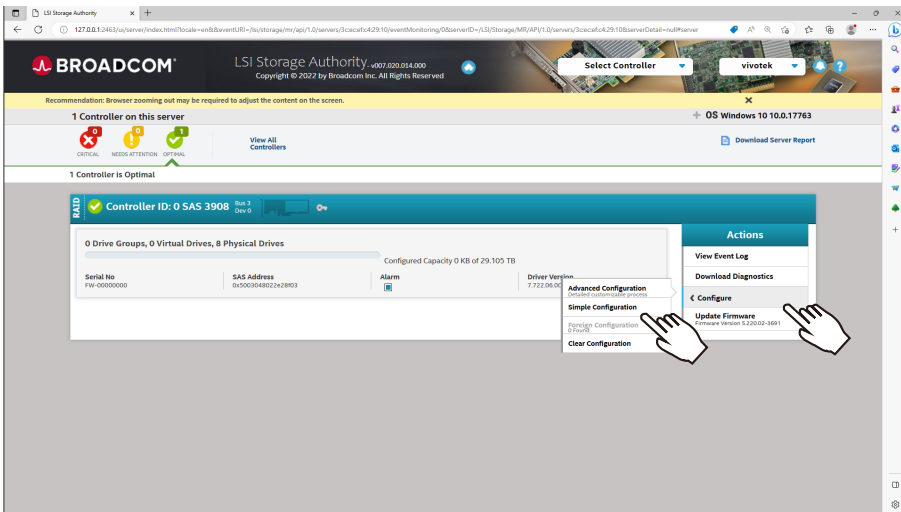

4. Select a RAID level.

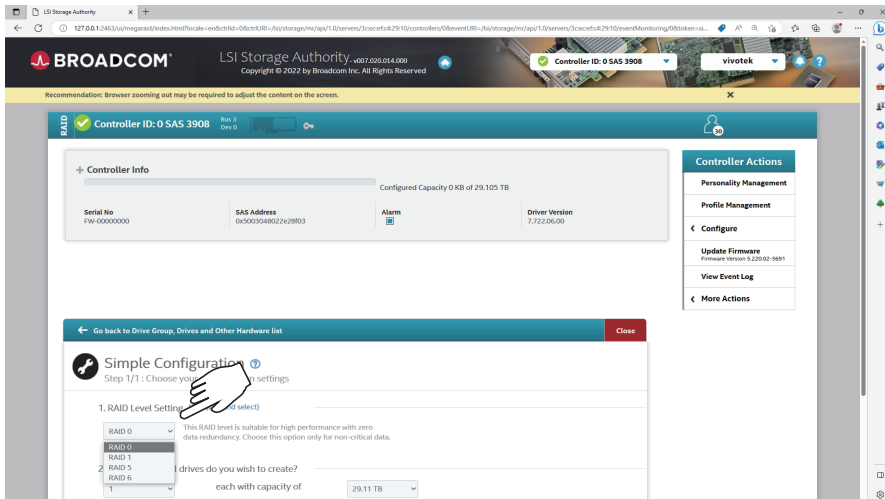

Refer to the next section: RAID Basics on page 40, for details about RAID levels.



5. Select the number of the Virtual Drive you want to create. If you have 16 hard drives, and you create 2 Virtual Drives, then each Virtual Drive will contain 8 member drives.

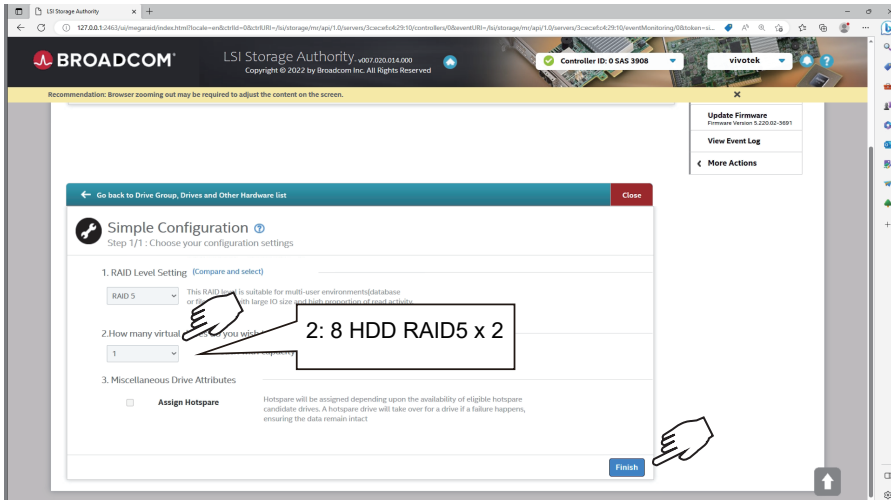

6. A completed configuration will look like this.

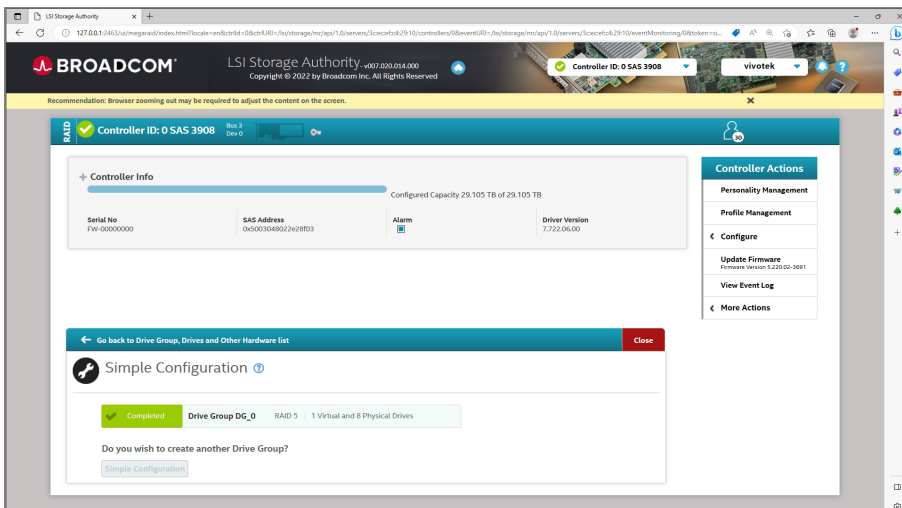

7. Review your Virtual Drive status.

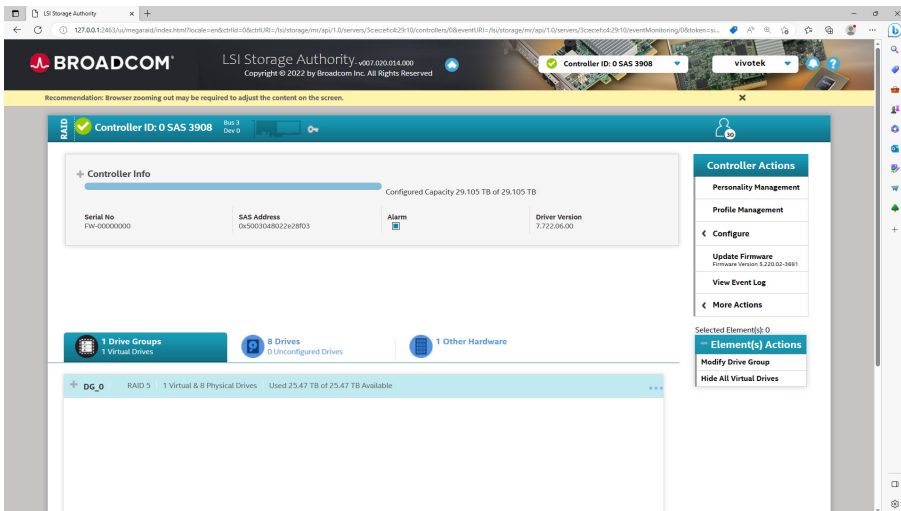

8. Double-click on the Disk Management shortcut on the desktop to open the utility.

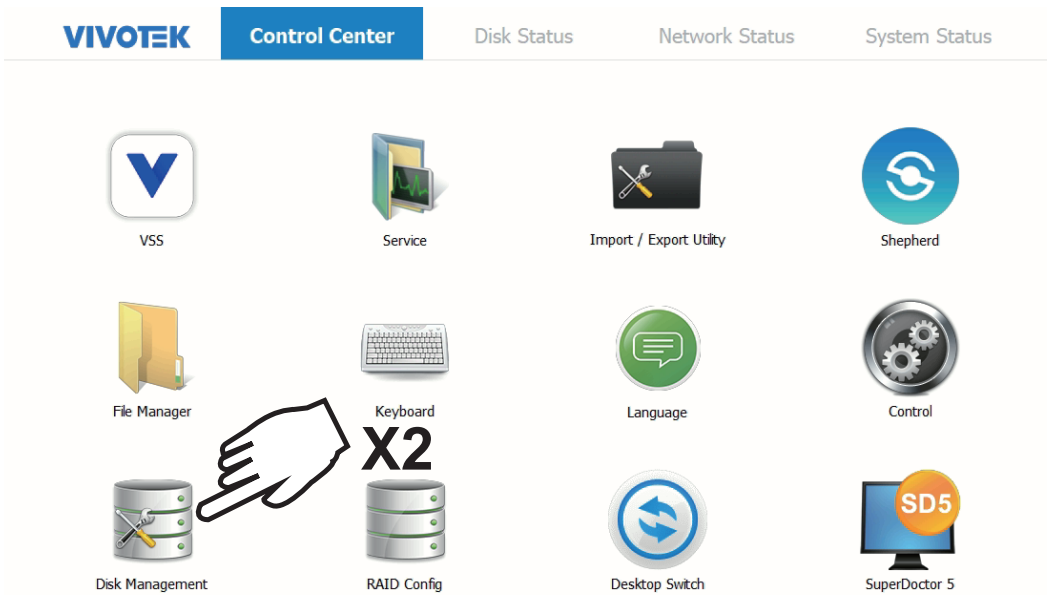

 NOTES:

1. You can find SuperDoctor® 5 (SD5), which monitors the hardware health or availability of the target node systems in data centers in real time and alerts administrators. Visit <https://www.supermicro.com/en/solutions/management-software/superdoctor> for details (including user manual).
2. In SD5, the following items on System info may display only general information and come with limited functionalities.
 - Desktop Monitor
 - Raid Card S/N number
 - Power supply
 - System cfg options
 - Update BIOS
3. You can also find the RAID CARD management tool. Please visit https://www.supermicro.com/en/products/accessories/addon/AOC-S3908L-H8IR_S3916L-H16IR.php for more information.

9. The virtual drive you created should appear as a new disk partition. You need to initialize and format the partition before using the disk capacity. Left-click to select and then right-click to display the command menu. Click Initialize Disk to proceed.

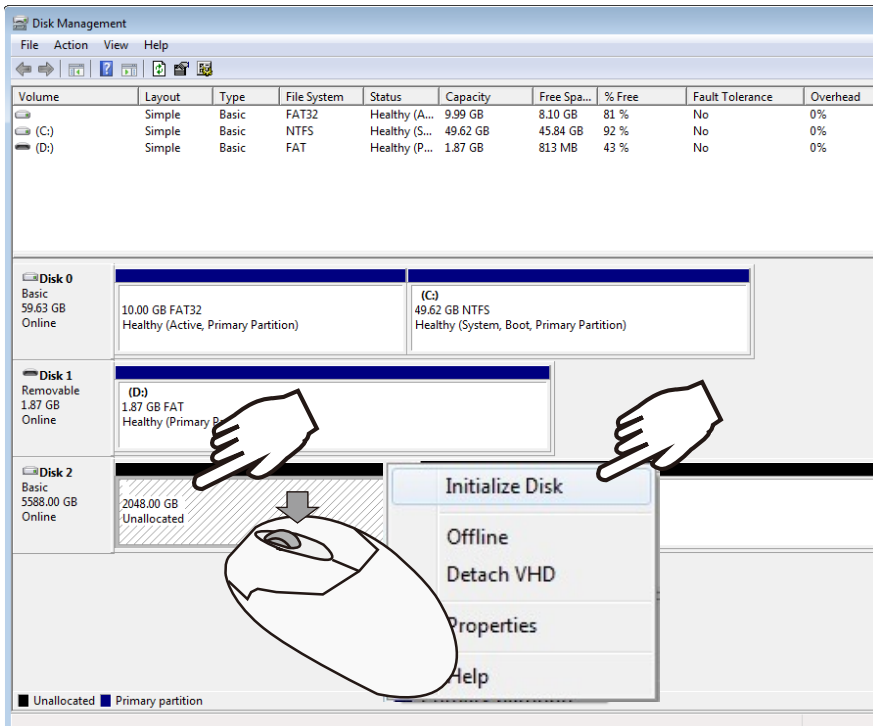

10. Select GPT (GUID Partition Table), and then click OK to proceed. This window may automatically pop up when Disk Management is started.

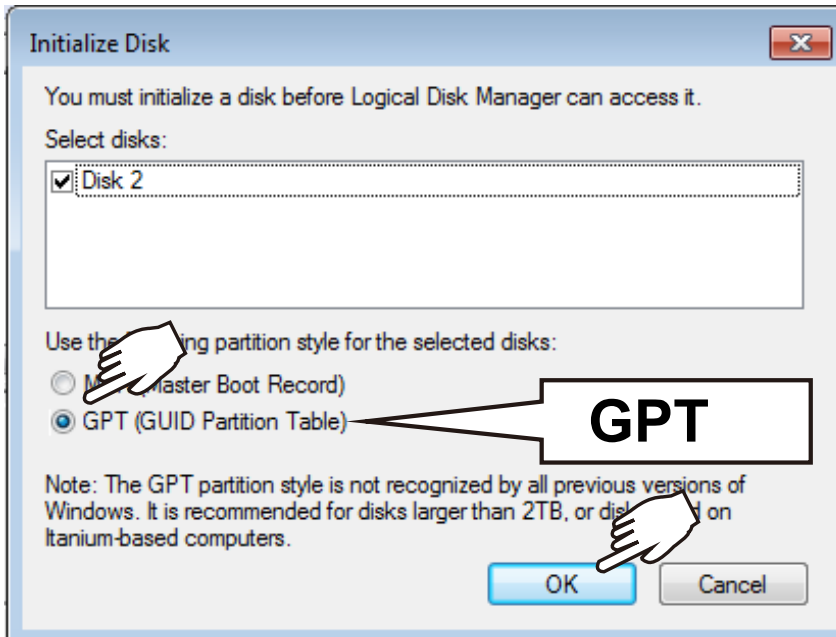

11. Once initialized, you can create a new volume. Right-click to display the New Simple Volume command. Click to proceed.

Please do not format drive C:. Doing so will disable the system.

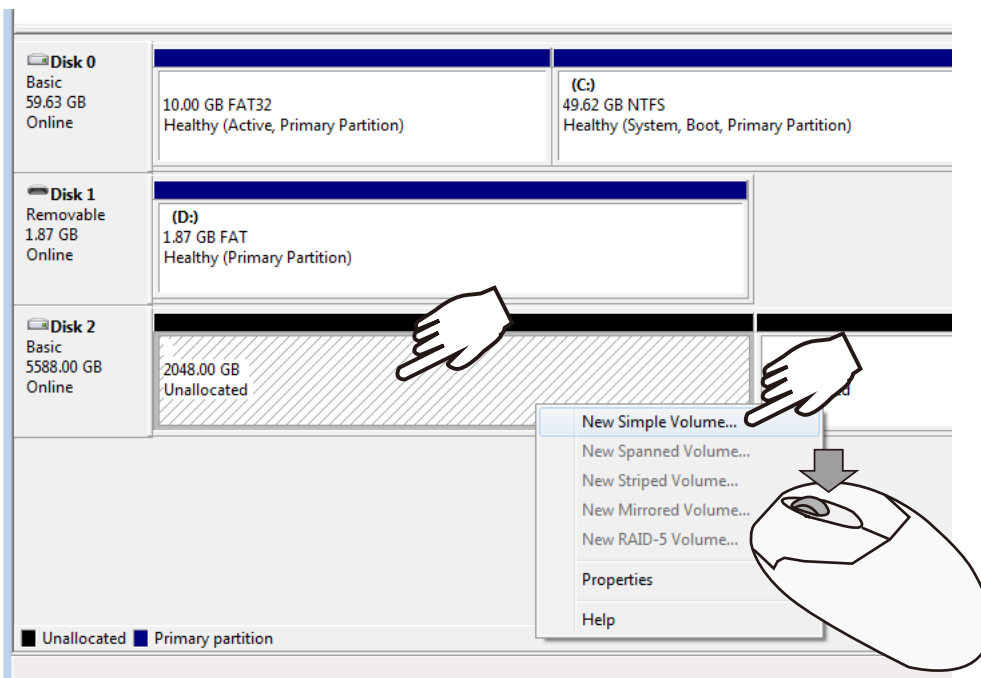

12. The New Simple Volume Wizard will prompt. Click Next to proceed.

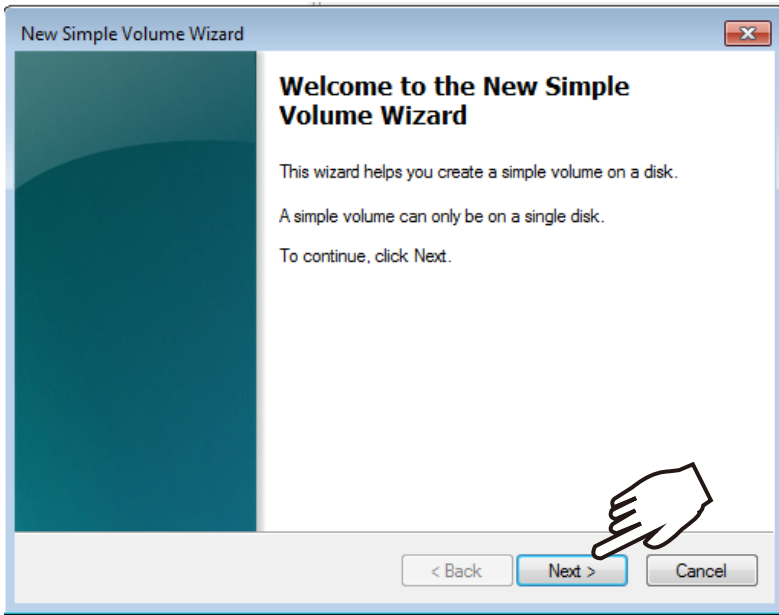

13. Leave the volume size unchanged. Click Next to proceed.

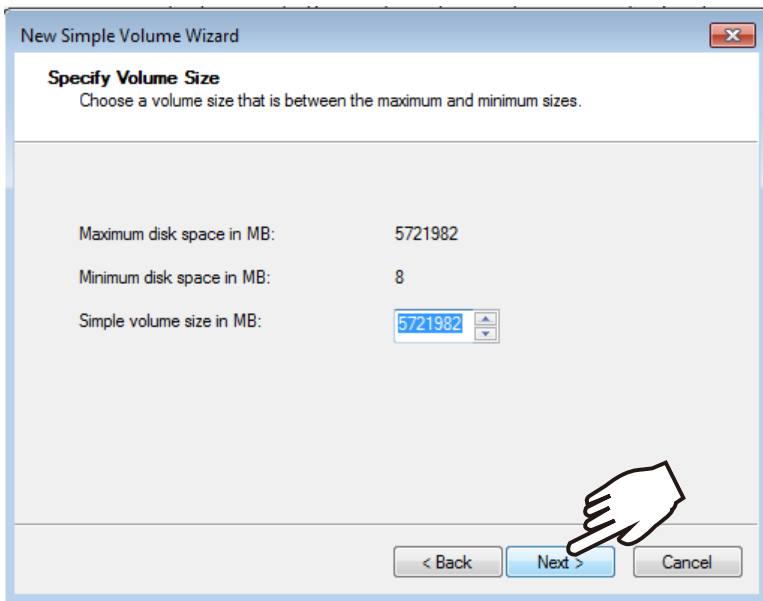

14. When prompted to assign a drive letter, click Next to proceed.

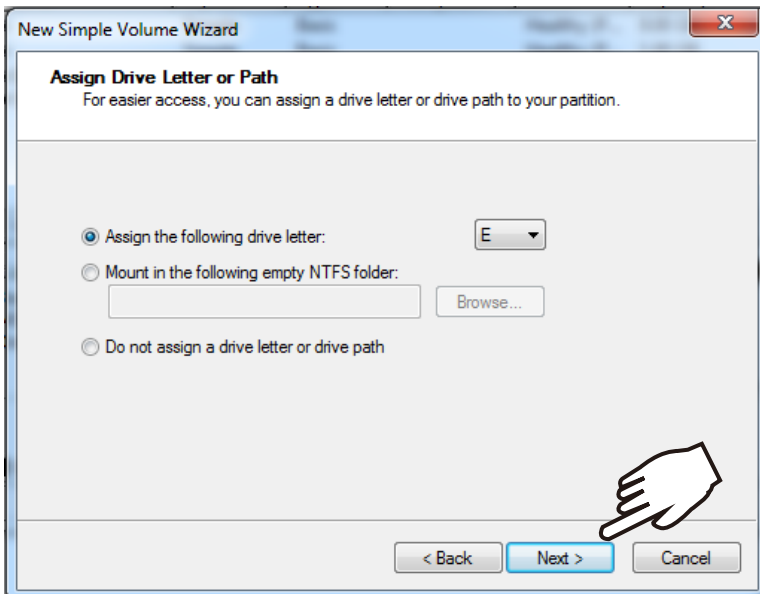

15. On the Format Partition page, select the Allocation unit size as 64KB. When done, click Next to proceed.

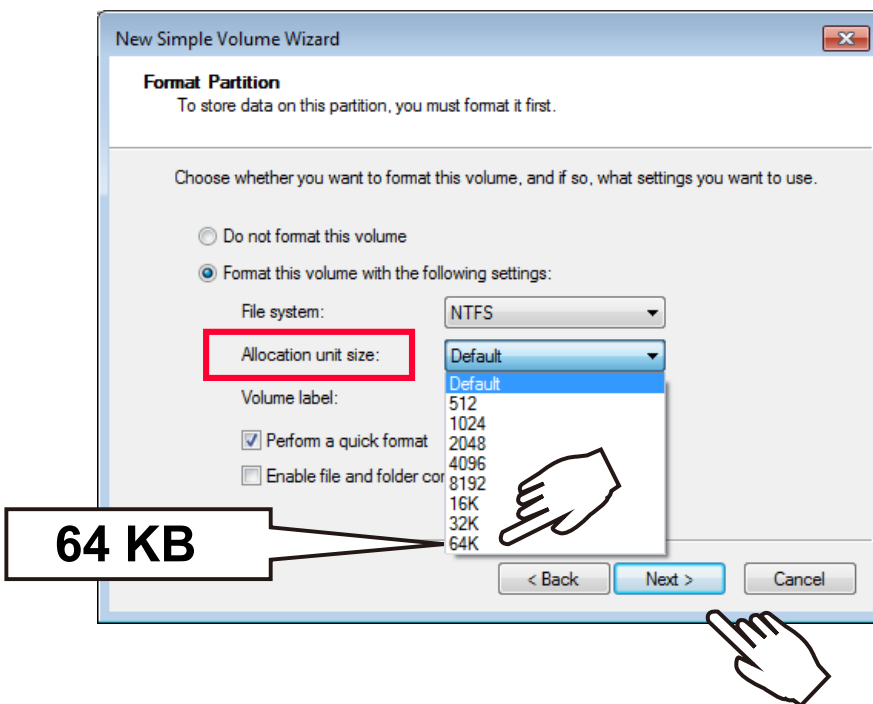

16. Click Finish to end the wizard.

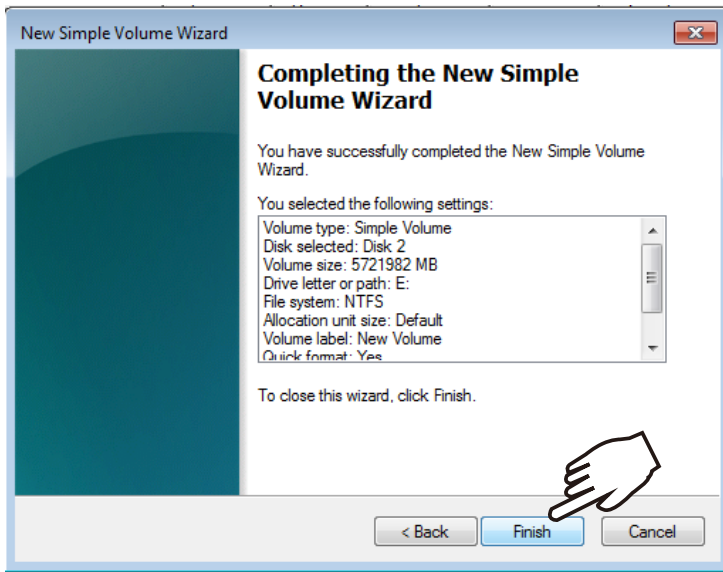

17. The formatting process will run in the background. When done, the new volume shall be indicated as a healthy new volume. Close the Disk Management window.

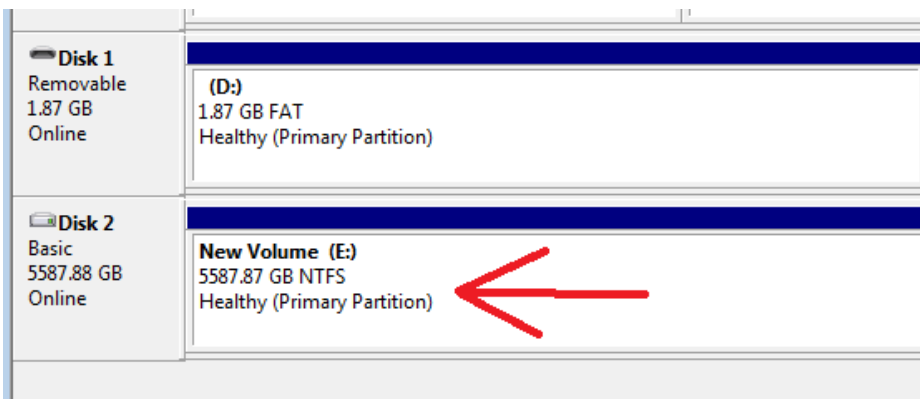
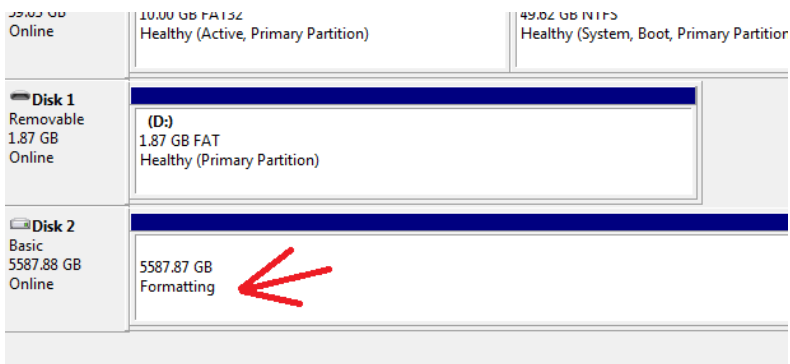

18. Start VIVOTEK VSS management software by double-clicking its shortcut. Enter admin and admin as the User Name and default Password. You can change the password later in the utility. Click Log in to proceed.

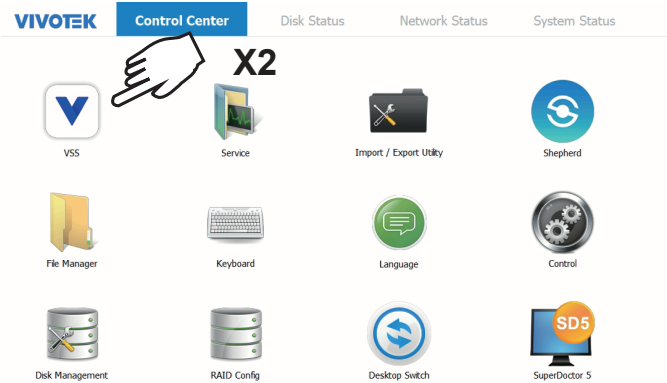

 admin / admin

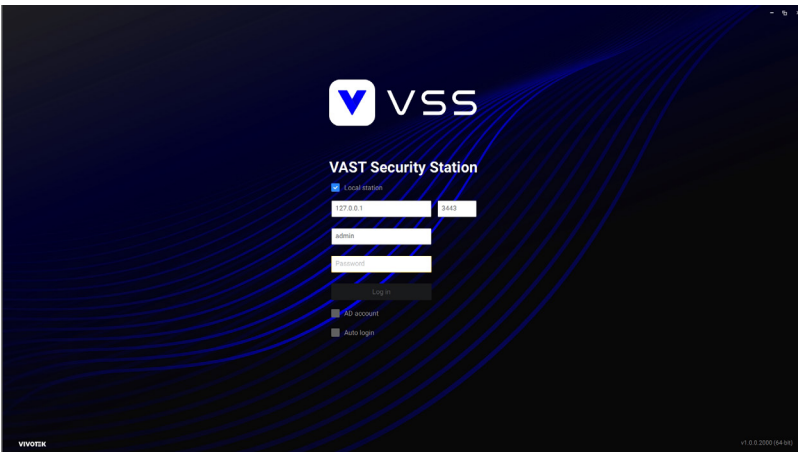

<p>Top row</p>	<p>Control Center: the default desktop. Disk Status: Displays the current storage volume status (system drive and RAID volumes). Network Status: Displays the information for the current network connections. System Status: Displays the current system status, license information, and VAST service.</p>	
<p>Desktop Shortcuts</p>	<p>VSS Service Import/Export Shepherd File Manager Keyboard Language Control Disk Management RAID Config.</p>	<p>Starts the VSS recording and management software. Enables you to start, stop, or restart the VAST server instance. Allows you to import or export VAST configurations. Use the Shepherd utility to locate cameras within your network. Provides access to the files in system disk drive volumes. Toggles the virtual keyboard in case you do not have a physical keyboard. Changes the UI language. . Opens the operating system's control panel. Starts the Disk Management utility in Windows. Starts the RAID card storage configuration utility.</p>



26. Select the recording volumes, such as the E:/ volume you just created. When done, click the Ready to use button.

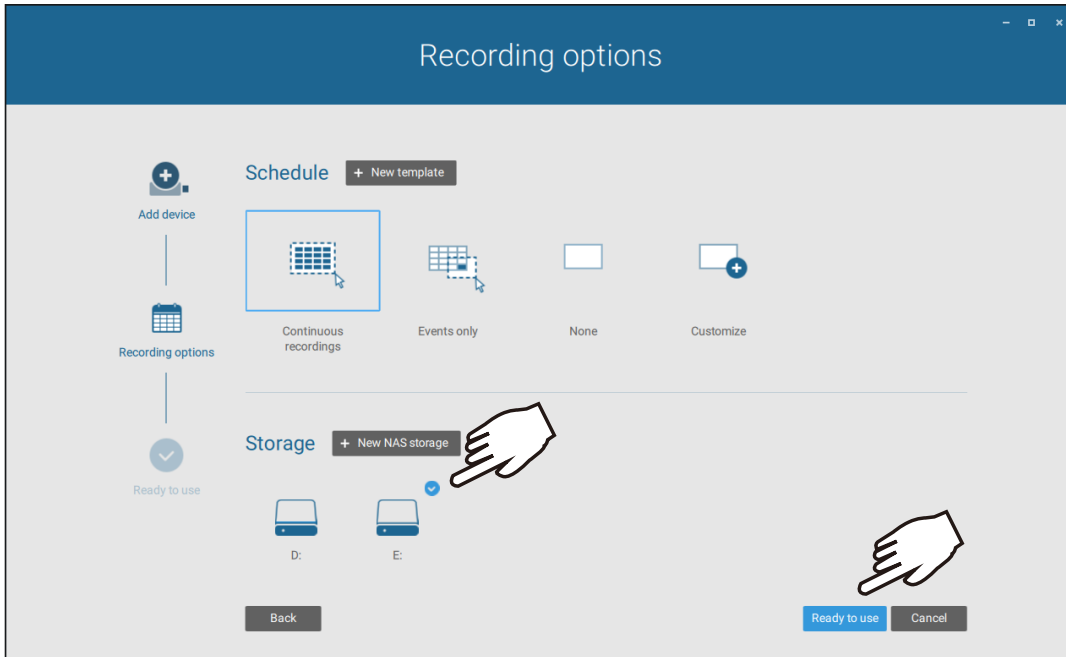

27. You should then enter the Liveview of the VSS software. Follow the discussions in later sections for how to configure your VSS deployment.

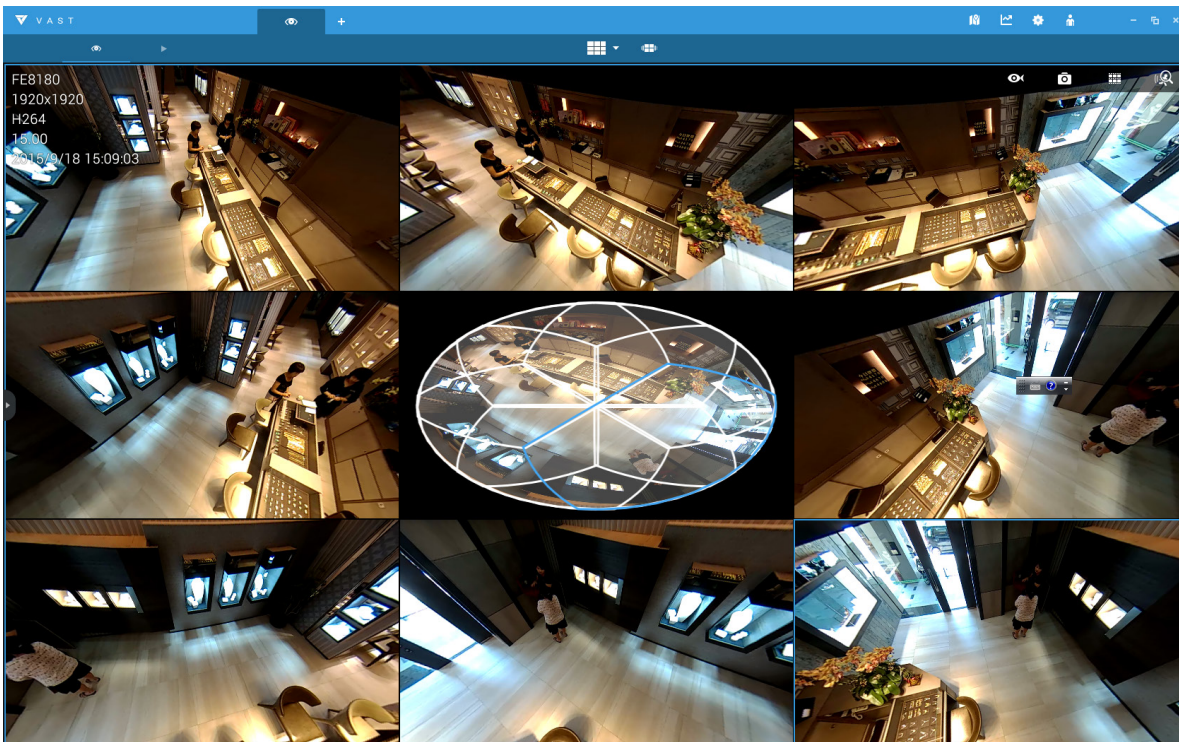

 NOTE:

1. Cameras and the NVR must reside in the same subnet. Otherwise, the NVR will not be able to recruit them into a recording configuration.
2. It is recommended all network cameras use static IPs. If you let a DHCP server assign IPs to these cameras, IPs may be changed later and the NVR may not recognize them.

If preferred, change the language of UI text using the Language shortcut on the desktop.

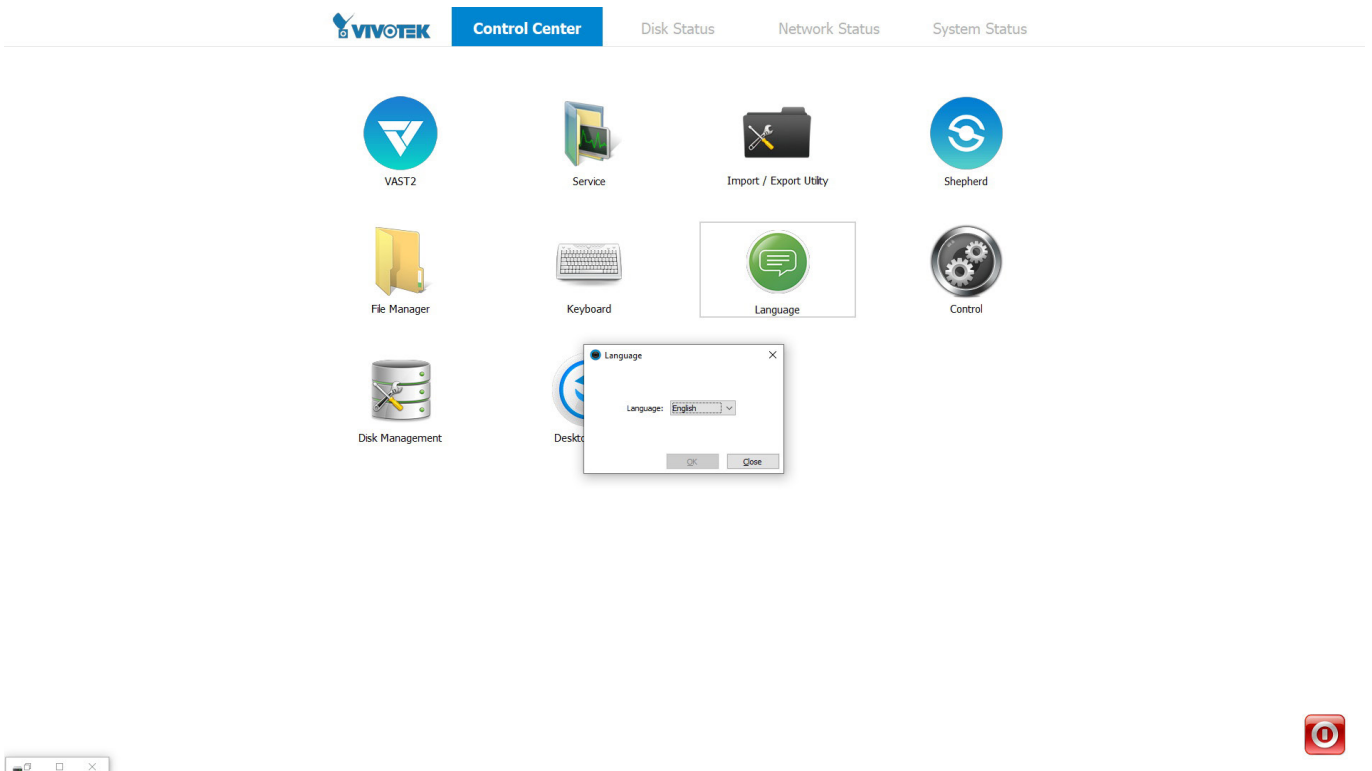

RAID Basics



IMPORTANT:

For a RAID volume configuration, it is recommended you use hard drives of the same model featuring the same capacity and rotation speed. It is also preferred that these drives are running the same version of firmware.

A Redundant Array of Independent Disks is an array, or group, of multiple independent physical drives that provide high performance and fault tolerance. A RAID drive group improves I/O performance and reliability. The RAID drive group appears to the host computer as a single storage volume or as multiple virtual units. An I/O transaction is expedited because several drives can be accessed simultaneously.

A RAID drive group improves data storage reliability and fault tolerance compared to single drive storage. Data loss resulting from a drive failure can be prevented by reconstructing missing data from the remaining drives. The benefits of RAID come from the improvement of I/O performance and the increased reliability.

What are the Virtual drives?

Virtual drives are drive groups that are available to the operating systems. The storage space in a virtual drive comes from all the members in the drive group.

The RAID functions available for virtual drives include:

- Hot spare drives.
- Drive group and virtual drive configurations.
- Initializing one or more virtual drives.
- Individual access to controllers, virtual drives, and disk drives.
- Failed drive rebuild.
- Verification of redundancy data in virtual drives using RAID levels 1, 5, 6, 10, 50, and 60.
- Reconstructing virtual drives after the RAID levels or adding a drive to a drive group.
- Independently selecting a host controller to work for.



RAID configuration components

- Drive group: a group of physical drives. These drives will be managed in partitions known as virtual drives.
- Virtual drive: a partition in a drive group made of contiguous data segments from the individual disk drives. A virtual drive can consist of the following components:
 - An entire drive group.
 - More than one entire drive group.
 - A part of drive group.
 - Parts of more than one drive group.
 - A combination of any two of the conditions above.



RAID Fault Tolerance

RAID Level	Number of Tolerable Drive Failures
0	No fault tolerance
1	1, each drive group
5	1
6	2
10	multiple, as long as each failure is in a separate drive group
50	1 in each drive group
60	2 in each group

For example, if disk failure occurs in different drive groups, a RAID10 configuration can tolerate multiple drive failures. In each RAID1 drive group, data is mirrored to a counterpart disk drive. Data remains intact if one disk drive should fail in each drive group.

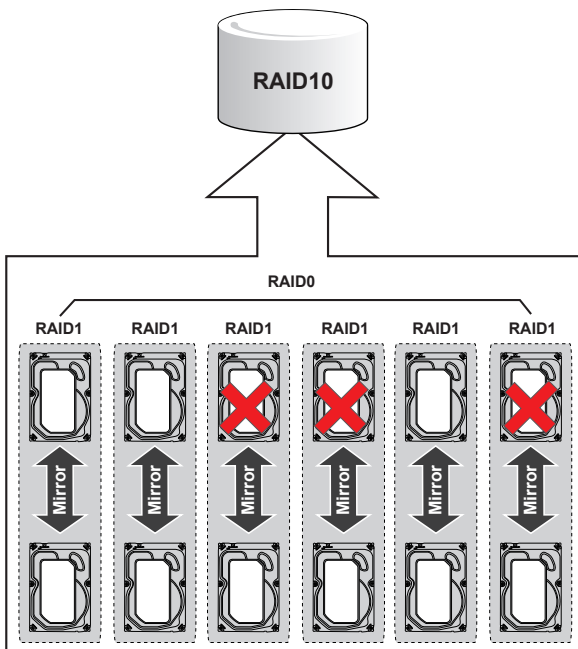

Consistency Check

The consistency check operation verifies the correctness of the data in virtual drives that use RAID levels 1, 5, 6, 10, 50, and 60. RAID0 does not provide data redundancy. In a system with parity, check consistency means calculating the data on one drive and comparing the results to the contents of the parity drive.



Background Initialization

Background initialization is a check for media errors on the drives when you create a virtual drive. It is an automatic operation that starts five minutes after you create a virtual drive. This check ensures that striped data segments are the same on all of the drives in the drive group.

Background initialization is similar to a consistency check. The difference between the two is that a background initialization is forced on new virtual drives and a consistency check is not.

New RAID 5 virtual drives and new RAID 6 virtual drives require a minimum number of drives for a background initialization to start. If fewer drives exist, the background initialization does not start. The background initialization needs to be started manually. The following number of drives are required:

- New RAID 5 virtual drives must have at least five drives for background initialization to start.
- New RAID 6 virtual drives must have at least seven drives for background initialization to start.

The default and recommended background initialization rate is 30 percent. Before you change the rebuild rate, you must stop the background initialization or the rate change will not affect the background initialization rate. After you stop background initialization and change the rebuild rate, the rate change takes effect when you restart background initialization.

2.1.7 Patrol Read



Disk Striping

Disk striping lets you write data across multiple drives instead of just one drive. Disk striping involves partitioning each drive storage space into stripes that can vary in size from a minimum of 64 KB to 1 MB for MegaRAID controllers and 64 KB for Integrated MegaRAID controllers. The LSI SAS2108 controller allows stripe size from 8 KB to 1 MB. These stripes are interleaved in a repeated sequential manner. The combined storage space is composed of stripes from each drive. It is recommended that you keep stripe sizes the same across RAID drive groups.

For example, in a four-disk system using only disk striping (used in RAID level 0), segment 1 is written to disk 1, segment 2 is written to disk 2, and so on. Disk striping enhances performance because multiple drives are accessed simultaneously, but disk striping does not provide data redundancy.

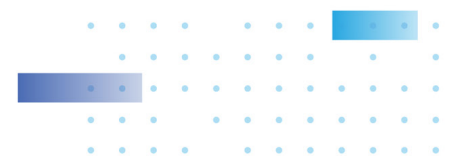
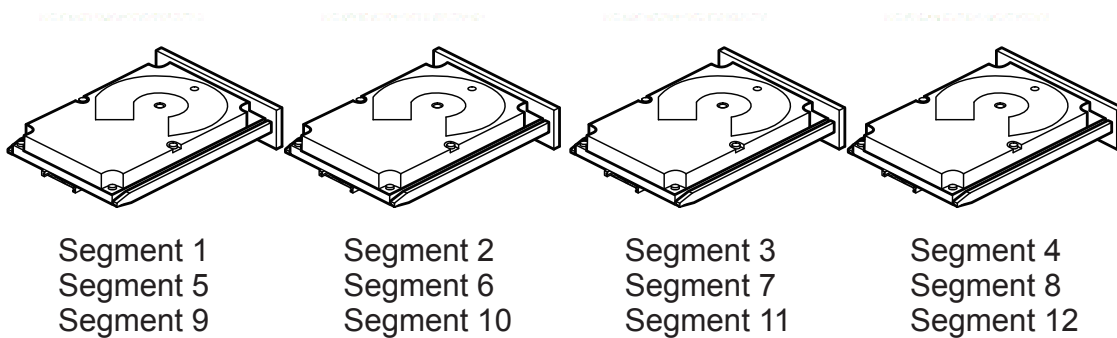

Stripe Width

Stripe width is the number of drives involved in a drive group where striping is implemented. For example, a four-disk drive group with disk striping has a stripe width of four.

Stripe Size

The stripe size is the length of the interleaved data segments that the RAID controller writes across multiple drives, not including parity drives. For example, consider a stripe that contains 1 MB of drive space and has 64 KB of data residing on each drive in the stripe. In this case, the stripe size is 1 MB and the strip size is 64 KB.

Strip Size

The strip size is the portion of a stripe that resides on a single drive.

Disk Mirroring

With disk mirroring (used in RAID 1 and RAID 10), data written to one drive is simultaneously written to another drive. The primary advantage of disk mirroring is that it provides 100 percent data redundancy. Because the contents of the disk are completely written to a second disk, data is not lost if one disk fails. In addition, both drives contain the same data at all times, so either disk can act as the operational disk. If one disk fails, the contents of the other disk can run the system and reconstruct the failed disk.

Disk mirroring provides 100 percent redundancy, but it is expensive because each drive in the system must be duplicated. The following figure shows an example of disk mirroring.

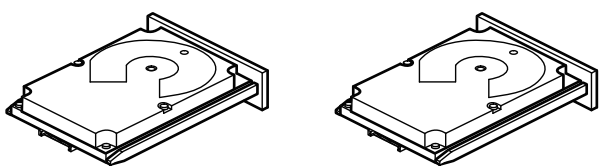

Segment 1	Segment 1 Duplicated
Segment 2	Segment 2 Duplicated
Segment 3	Segment 3 Duplicated
Segment 4	Segment 4 Duplicated

3_01080-00

Parity

Parity generates a set of redundancy data from two or more parent data sets. The redundancy data can be used to reconstruct one of the parent data sets in the event of a drive failure. Parity data does not fully duplicate the parent data sets, but parity generation can slow the write process. In a RAID drive group, this method is applied to entire drives or stripes across all of the drives in a drive group. The types of parity are described in the following table.



Parity Type	Description
Dedicated	The parity data on two or more drives is stored on an additional disk.
Distributed	The parity data is distributed across more than one drive in the system.

A RAID 5 drive group combines distributed parity with disk striping. If a single drive fails, it can be rebuilt from the parity and the data on the remaining drives. An example of a RAID 5 drive group is shown in the following figure. A RAID 5 drive group uses parity to provide redundancy for one drive failure without duplicating the contents of entire drives. A RAID 6 drive group also uses distributed parity and disk striping, but adds a second set of parity data so that it can survive up to two drive failures.

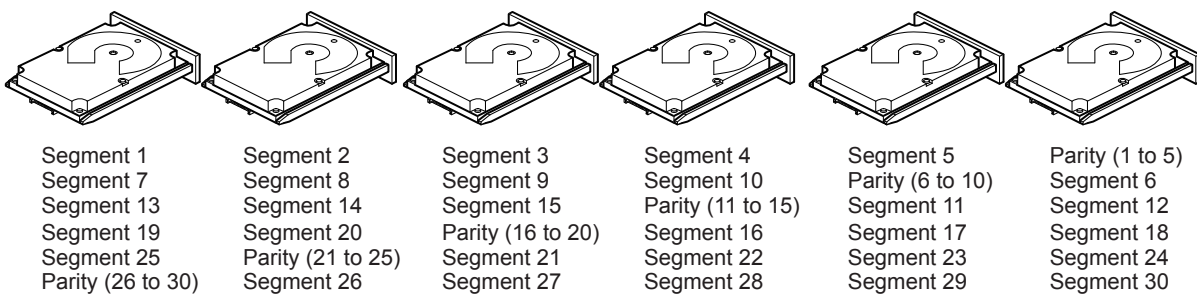

Disk Spanning

Disk spanning allows multiple drives to function like one big drive. Spanning overcomes lack of disk space and simplifies storage management by combining existing resources or adding relatively inexpensive resources. For example, four 20-GB drives can be combined to appear to the operating system as a single 80-GB drive. Spanning alone does not provide reliability or performance enhancements. Spanned virtual drives must have the same stripe size and must be contiguous. In the following figure, RAID 1 drive groups are turned into a RAID 10 drive group.

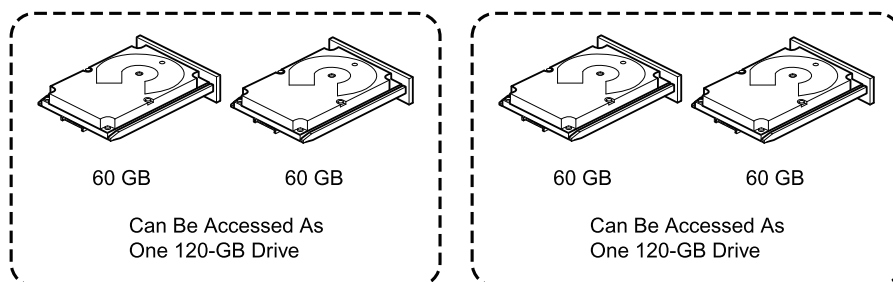

Spanning two contiguous RAID 0 virtual drives does not produce a new RAID level or add fault tolerance. It does increase the capacity of the virtual drive and improves performance by doubling the number of spindles.

Spanning for RAID 00, RAID 10, RAID 50, and RAID 60 Drive Groups

The following table describes how to configure RAID 00, RAID 10, RAID 50, and RAID 60 drive groups by spanning. The virtual drives must have the same stripe size and the maximum number of spans is 8. The full drive capacity is used when you span virtual drives; you cannot specify a smaller drive capacity.



Level	Description
00	Configure a RAID 00 by spanning two or more contiguous RAID 0 virtual drives, up to the maximum number of supported devices for the controller.
10	Configure RAID 10 by spanning two or more contiguous RAID 1 virtual drives, up to the maximum number of supported devices for the controller. A RAID 10 drive group supports a maximum of 8 spans. You must use an even number of drives in each RAID virtual drive in the span. The RAID 1 virtual drives must have the same stripe size.
50	Configure a RAID 50 drive group by spanning two or more contiguous RAID 5 virtual drives. The RAID 5 virtual drives must have the same stripe size.
60	Configure a RAID 60 drive group by spanning two or more contiguous RAID 6 virtual drives. The RAID 6 virtual drives must have the same stripe size.

Hot Spares

A hot spare is an extra, unused drive that is part of the disk subsystem. It is usually in Standby mode, ready for service if a drive fails. Hot spares let you replace failed drives without system shutdown or user intervention. The MegaRAID SAS RAID controllers can implement automatic and transparent rebuilds of failed drives using hot spare drives, which provide a high degree of fault tolerance and zero downtime.

The RAID management software lets you specify drives as hot spares. When a hot spare is needed, the RAID controller assigns the hot spare that has a capacity closest to and at least as great as that of the failed drive to take the place of the failed drive. The failed drive is removed from the virtual drive and marked ready awaiting removal after the rebuild to a hot spare begins. You can make hot spares of the drives that are not in a RAID virtual drive.

You can use the RAID management software to designate the hot spare to have enclosure affinity, which means that if drive failures are present on a split backplane configuration, the hot spare will be used first on the backplane side in which it resides. If the hot spare is designated as having enclosure affinity, it tries to rebuild any failed drives on the backplane in which it resides before rebuilding any other drives on other backplanes.

The hot spare can be of two types:

- Global hot spare
- Dedicated hot spare



Global Hot Spare

Use a global hot spare drive to replace any failed drive in a redundant drive group as long as its capacity is equal to or larger than the coerced capacity of the failed drive. A global hot spare defined on any channel should be available to replace a failed drive on both channels.

Dedicated Hot Spare

Use a dedicated hot spare to replace a failed drive only in a selected drive group. One or more drives can be designated as a member of a spare drive pool. The most suitable drive from the pool is selected for failover. A dedicated hot spare is used before one from the global hot spare pool.



Hot spare drives can be located on any RAID channel. Standby hot spares (not being used in RAID drive group) are polled every 60 seconds at a minimum, and their status made available in the drive group management software. RAID controllers offer the ability to rebuild with a disk that is in a system but not initially set to be a hot spare.

Observe the following parameters when using hot spares:

- Hot spares are used only in drive groups with redundancy: RAID levels 1, 5, 6, 10, 50, and 60.
- A hot spare connected to a specific RAID controller can be used to rebuild a drive that is connected only to the same controller.
- You must assign the hot spare to one or more drives through the controller BIOS or use drive group management software to place it in the hot spare pool.
- A hot spare must have free space equal to or greater than the drive it replaces. For example, to replace a 500-GB drive, the hot spare must be 500-GB or larger.

Disk Rebuilds

When a drive in a RAID drive group fails, you can rebuild the drive by re-creating the data that was stored on the drive before it failed. The RAID controller re-creates the data using the data stored on the other drives in the drive group. Rebuilding can be performed only in drive groups with data redundancy, which includes RAID 1, 5, 6, 10, 50, and 60 drive groups.

The RAID controller uses hot spares to rebuild failed drives automatically and transparently, at user-defined rebuild rates. If a hot spare is available, the Rebuild operation can start automatically when a drive fails. If a hot spare is not available, the failed drive must be replaced with a new drive so that the data on the failed drive can be rebuilt.

The failed drive is removed from the virtual drive and marked ready awaiting removal when the Rebuild operation to a hot spare begins. If the system goes down during a Rebuild operation, the RAID controller automatically resumes the rebuild after the system reboots.

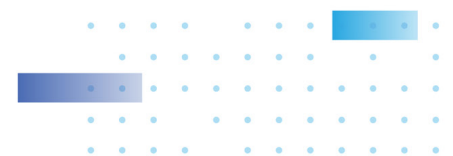



NOTE:

When the Rebuild operation to a hot spare begins, the failed drive is often removed from the virtual drive before management applications detect the failed drive. When this removal occurs, the event logs show the drive rebuilding to the hot spare without showing the failed drive. The formerly failed drive will be marked as ready after a Rebuild operation begins to a hot spare. If a source drive fails during a rebuild to a hot spare, the Rebuild operation fails, and the failed source drive is marked as offline. In addition, the rebuilding hot spare drive is changed back to a hot spare. After a Rebuild operation fails because of a source drive failure, the dedicated hot spare is still dedicated and assigned to the correct drive group, and the global hot spare is still global.

An automatic drive Rebuild operation will not start if you replace a drive during a RAID-level migration. The Rebuild operation must be started manually after the expansion or migration procedure is complete. (RAID-level migration changes a virtual drive from one RAID level to another.)



Hot Swap

A hot swap is the manual replacement of a defective drive unit while the computer is still running. When a new drive has been installed, a Rebuild operation occurs automatically if these situation occurs:

- The newly inserted drive is the same capacity as or larger than the failed drive.
- The newly inserted drive is placed in the same drive bay as the failed drive it is replacing.

The RAID controller can be configured to detect the new drives and rebuild the contents of the drive automatically.

Drive States

A drive state is a property indicating the status of the drive. The drive states are described in the following table.

Parity Type	Description
Online	A drive that can be accessed by the RAID controller and is part of the virtual drive.
Unconfigured Good	A drive that is functioning normally but is not configured as a part of a virtual drive or as a hot spare.
Hot Spare	A drive that is powered up and ready for use as a spare in case an online drive fails.
Failed	A drive that was originally configured as Online or Hot Spare, but on which the firmware detects an unrecoverable error.
Rebuild	A drive to which data is being written to restore full redundancy for a virtual drive.
Unconfigured Bad	A drive on which the firmware detects an unrecoverable error; the drive was Unconfigured Good or the drive could not be initialized.
Missing	A drive that was Online but which has been removed from its location.
Offline	A drive that is part of a virtual drive but which has invalid data as far as the RAID configuration is concerned.
Shield State	An interim state of physical drive for diagnostic operations.
Copyback	A drive that has replaced the failed drive in the RAID configuration.



Virtual Drive States

The virtual drive states are described in the following table.

Parity Type	Description
Online	The virtual drive operating condition is good. All configured drives are online.
Degraded	The virtual drive operating condition is not optimal. One of the configured drives has failed or is offline.
Partial Degraded	The operating condition in a RAID 6 virtual drive is not optimal. One of the configured drives has failed or is offline. A RAID 6 drive group can tolerate up to two drive failures.
Failed	The virtual drive has failed.
Offline	The virtual drive is not available to the RAID controller.

RAID Levels

The RAID controller supports RAID levels 0, 00, 1, 5, 6, 10, 50, and 60. The supported RAID levels are summarized in the following section.

In addition, the RAID controller supports independent drives (configured as RAID 0 and RAID 00 drive groups) The following sections describe the RAID levels in detail.

Summary of RAID Levels

A RAID 0 drive group uses striping to provide high data throughput, especially for large files in an environment that does not require fault tolerance.

A RAID 1 drive group uses mirroring so that data written to one drive is simultaneously written to another drive. The RAID 1 drive group is good for small databases or other applications that require small capacity but complete data redundancy.



A RAID 5 drive group uses disk striping and parity data across all drives (distributed parity) to provide high data throughput, especially for small random access. A RAID 6 drive group uses distributed parity, with two independent parity blocks per stripe, and disk striping.

A RAID 6 virtual drive can survive the loss of any two drives without losing data. A RAID 6 drive group, which requires a minimum of three drives, is similar to a RAID 5 drive group. Blocks of data and parity information are written across all drives. The parity information is used to recover the data if one or two drives fail in the drive group.

A RAID 00 drive group is a spanned drive group that creates a striped set from a series of RAID 0 drive groups. A RAID 10 drive group, a combination of RAID 0 and RAID 1 drive groups, consists of striped data across mirrored spans.

A RAID 10 drive group is a spanned drive group that creates a striped set from a series of mirrored drives. A RAID 10 drive group allows a maximum of 8 spans. You must use an even number of drives in each RAID virtual drive in the span. The RAID 1 virtual drives must have the same stripe size. A RAID 10 drive group provides high data throughput and complete data redundancy but uses a larger number of spans.

A RAID 50 drive group, a combination of RAID 0 and RAID 5 drive groups, uses distributed parity and disk striping. A RAID 50 drive group is a spanned drive group in which data is striped across multiple RAID 5 drive groups. A RAID 50 drive group works best with data that requires high reliability, high request rates, high data transfers, and medium-to-large capacity.

 **NOTE**

Having virtual drives of different RAID levels, such as RAID Level 0 and RAID Level 5, in the same drive group is not allowed. For example, if an existing RAID 5 virtual drive is created out of partial space in an array, the next virtual drive in the array has to be RAID Level 5 only.



A RAID 60 drive group, a combination of RAID level 0 and RAID Level 6, uses distributed parity, with two independent parity blocks per stripe in each RAID set, and disk striping. A RAID 60 virtual drive can survive the loss of two drives in each of the RAID 6 sets without losing data. A RAID 60 drive group works best with data that requires high reliability, high request rates, high data transfers, and medium-to-large capacity.



NOTE

The MegaSR controller supports the standard RAID levels – RAID0, RAID1, RAID5, and RAID10. The MegaSR controller comes in two variants, SCU and AHCI, both supporting a maximum of eight physical drives. A maximum of eight virtual drives can be created (using RAID0, RAID 1, RAID5, and RAID10 only) and controlled by the MegaSR controller. One virtual drive can be created on an array (a maximum of eight if no other virtual drives are already created on the MegaSR controller), or you can create eight arrays with one virtual drive each. However, on a RAID10 drive group, you can create only one virtual drive on a particular array.



RAID 0 Drive Groups

A RAID 0 drive group provides disk striping across all drives in the RAID drive group. A RAID0 drive group does not provide any data redundancy, but the RAID 0 drive group offers the best performance of any RAID level. The RAID 0 drive group breaks up data into smaller segments, and then stripes the data segments across each drive in the drive group. The size of each data segment is determined by the stripe size. A RAID 0 drive group offers high bandwidth.

By breaking up a large file into smaller segments, the RAID controller can use both SAS drives and SATA drives to read or write the file faster. A RAID 0 drive group involves no parity calculations to complicate the write operation. This situation makes the RAID 0 drive group ideal for applications that require high bandwidth but do not require fault tolerance. The following table provides an overview of the RAID 0 drive group. The following figure provides a graphic example of a RAID 0 drive group.

 **NOTE**

RAID level 0 is not fault tolerant. If a drive in a RAID 0 drive group fails, the entire virtual drive (all drives associated with the virtual drive) fails.

Uses	Provides high data throughput, especially for large files. Any environment that does not require fault tolerance.
Strong points	Provides increased data throughput for large files. No capacity loss penalty for parity.
Weak points	Does not provide fault tolerance or high bandwidth. All data is lost if any drive fails.
Drives	1 to 32

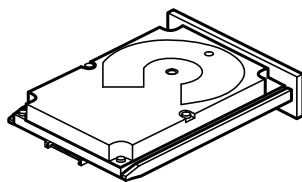

Segment 1
Segment 3
Segment 5
Segment 7

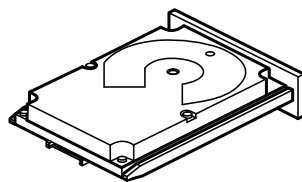

Segment 2
Segment 4
Segment 6
Segment 8



RAID 1 Drive Groups

In RAID 1 drive groups, the RAID controller duplicates all data from one drive to a second drive in the drive group. A RAID 1 drive group supports an even number of drives from 2 through 32 in a single span. The RAID1 drive group provides complete data redundancy, but at the cost of doubling the required data storage capacity. The following table provides an overview of a RAID1 drive group. The following figure provides a graphic example of a RAID1 drive group.

Uses	Use RAID 1 drive groups for small databases or any other environment that requires fault tolerance but small capacity.
Strong points	Provides complete data redundancy.A RAID 1 drive group is ideal for any application that requires fault tolerance and minimal capacity.
Weak points	Requires twice as many drives. Performance is impaired during drive rebuilds.
Drives	2 through 32 (must be an even number of drives)

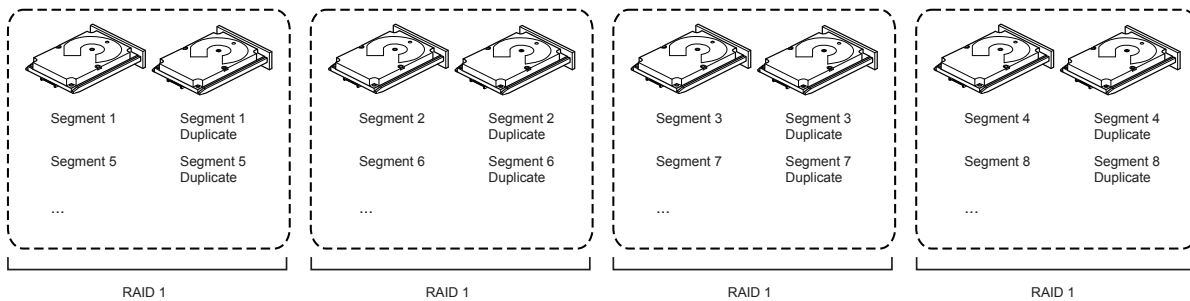

RAID 5 Drive Groups

A RAID 5 drive group includes disk striping at the block level and parity. Parity is the data's property of being odd or even, and parity checking is used to detect errors in the data. In RAID5 drive groups, the parity information is written to all drives. A RAID5 drive group is best suited for networks that perform a lot of small input/output (I/O) transactions simultaneously.The following table provides an overview of a RAID5 drive group. The following figure provides a graphic example of a RAID5 drive group.

Uses	Provides high data throughput, especially for large files. Use RAID 5 drive groups for transaction processing applications because each drive can read and write independently. If a drive fails, the RAID controller uses the parity drive to re-create all missing information.Use also for online customer service that requires fault tolerance. Use for any application that has high read request rates but random write request rates.
Strong points	Provides data redundancy, high read rates, and good performance in most environments.Provides redundancy with lowest loss of capacity.
Weak points	Not well suited to tasks requiring lots of small writes or small block write operations.Suffers more impact if no cache is used. Drive performance is reduced if a drive is being rebuilt. Environments with few processes do not perform as well because the RAID drive group overhead is not offset by the performance gains in handling simultaneous processes.
Drives	3 through 32

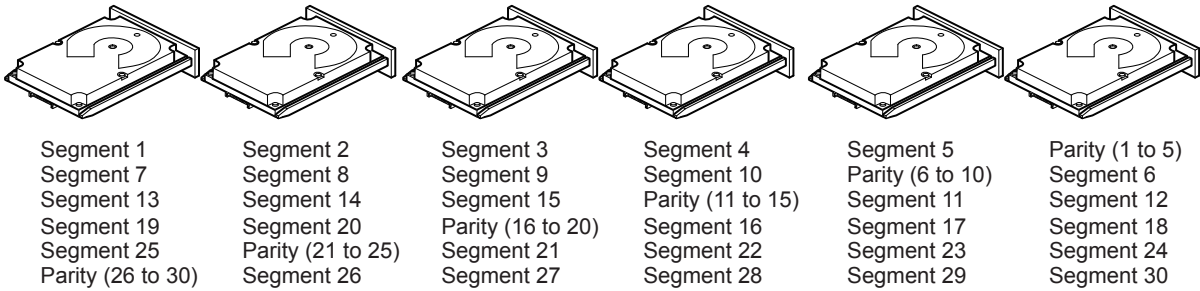

RAID 6 Drive Groups

A RAID6 drive group is similar to a RAID5 drive group (disk striping and parity), except that instead of one parity block per stripe, there are two. With two independent parity blocks, A RAID6 drive group can survive the loss of any two drives in a virtual drive without losing data. A RAID6 drive group provides a high level of data protection through the use of a second parity block in each stripe. Use a RAID6 drive group for data that requires a very high level of protection from loss.

In the case of a failure of one drive or two drives in a virtual drive, the RAID controller uses the parity blocks to re-create all of the missing information. If two drives in a RAID6 virtual drive fail, two drive rebuilds are required, one for each drive. These rebuilds do not occur at the same time. The controller rebuilds one failed drive, and then the other failed drive. The following table provides an overview of a RAID6 drive group.

Uses	Use for any application that has high read request rates but low random or small block write rates.
Strong points	Provides data redundancy, high read rates, and good performance in most environments. Can survive the loss of two drives or the loss of a drive while another drive is being rebuilt. Provides the highest level of protection against drive failures of all of the RAID levels. Performance is similar to that of a RAID5 drive group.
Weak points	Not well-suited to tasks requiring a lot of small and/or random write operations. A RAID 6 virtual drive must generate two sets of parity data for each write operation, which results in a significant decrease in performance during write operations. Drive performance is reduced during a drive Rebuild operation. Environments with few processes do not perform as well because the RAID overhead is not offset by the performance gains in handling simultaneous processes. A RAID6 drive group costs more because of the extra capacity required by using two parity blocks per stripe.
Drives	3 through 32



The following figure shows a RAID6 drive group data layout. The second set of parity drives is denoted by Q. The P drives follow the RAID5 drive group parity scheme.

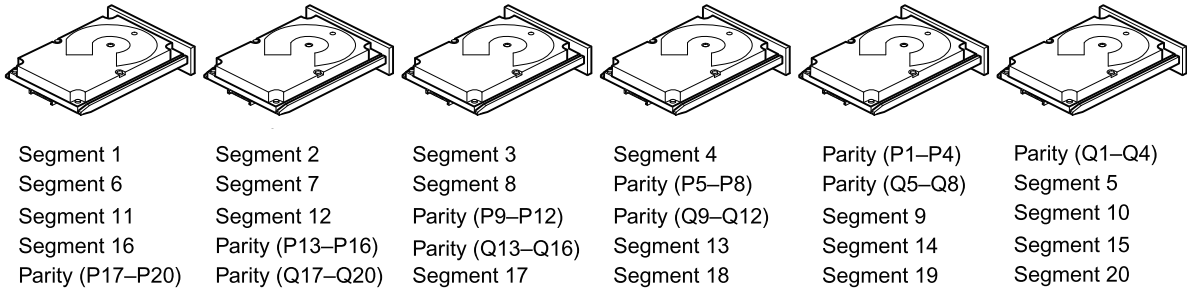

Note: Parity is distributed across all drives in the drive group.



RAID 00 Drive Groups

A RAID 00 drive group is a spanned drive group that creates a striped set from a series of RAID0 drive groups. A RAID00 drive group does not provide any data redundancy, but, along with the RAID0 drive group, does offer the best performance of any RAID level. A RAID00 drive group breaks up data into smaller segments and then stripes the data segments across each drive in the drive groups. The size of each data segment is determined by the stripe size. A RAID00 drive group offers high bandwidth.



NOTE

RAID level 00 is not fault tolerant. If a drive in a RAID 0 drive group fails, the entire virtual drive (all drives associated with the virtual drive) fails.

By breaking up a large file into smaller segments, the controller can use both SAS drives and SATA drives to read or write the file faster. A RAID00 drive group involves no parity calculations to complicate the write operation. This situation makes the RAID00 drive group ideal for applications that require high bandwidth but do not require fault tolerance. The following table provides an overview of the RAID00 drive group. The following figure provides a graphic example of a RAID 00 drive group.

Uses	Provides high data throughput, especially for large files. Any environment that does not require fault tolerance.
Strong points	Provides increased data throughput for large files. No capacity loss penalty for parity.
Weak points	Does not provide fault tolerance or high bandwidth. All data lost if any drive fails.
Drives	2 through 256

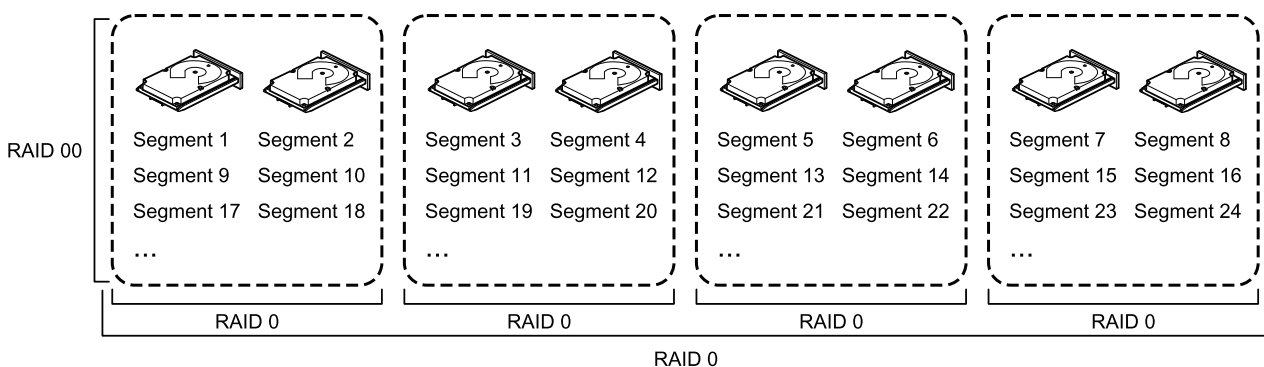

RAID 10

A RAID10 drive group is a combination of RAID level 0 and RAID level 1, and it consists of stripes across mirrored drives. A RAID10 drive group breaks up data into smaller blocks and then mirrors the blocks of data to each RAID1 drive group. The first RAID1 drive in each drive group then duplicates its data to the second drive. The size of each block is determined by the stripe size parameter, which is set during the creation of the RAID set. The RAID 1 virtual drives must have the same stripe size.

Spanning is used because one virtual drive is defined across more than one drive group. Virtual drives defined across multiple RAIDlevel 1 drive groups are referred to as RAID level 10, (1+0). Data is striped across drive groups to increase performance by enabling access to multiple drive groups simultaneously.

Each spanned RAID 10 virtual drive can tolerate multiple drive failures, as long as each failure is in a separate drive group. If drive failures occur, less than total drive capacity is available.

Configure RAID 10 drive groups by spanning two contiguous RAID1 virtual drives, up to the maximum number of supported devices for the controller. A RAID10 drive group supports a maximum of 8spans, with a maximum of 32drives per span. You must use an even number of drives in each RAID10 virtual drive in the span.



NOTE

Other factors, such as the type of controller, can restrict the number of drives supported by RAID 10 virtual drives.



The following table provides an overview of a RAID10 drive group.

Uses	<p>Appropriate when used with data storage that needs 100 percent redundancy of mirrored drive groups and that also needs the enhanced I/O performance of RAID 0 (striped drive groups.)</p> <p>A RAID10 drive group works well for medium-sized databases or any environment that requires a higher degree of fault tolerance and moderate-to-medium capacity.</p>
Strong points	Provides both high data transfer rates and complete data redundancy.
Weak points	Requires twice as many drives as all other RAID levels except in RAID 1 drive groups.
Drives	4 to 32 in multiples of 4 — The maximum number of drives supported by the controller (using an even number of drives in each RAID 10 virtual drive in the span).

In the following figure, virtual drive 0 is created by distributing data across four drive groups (drive groups 0 through3).

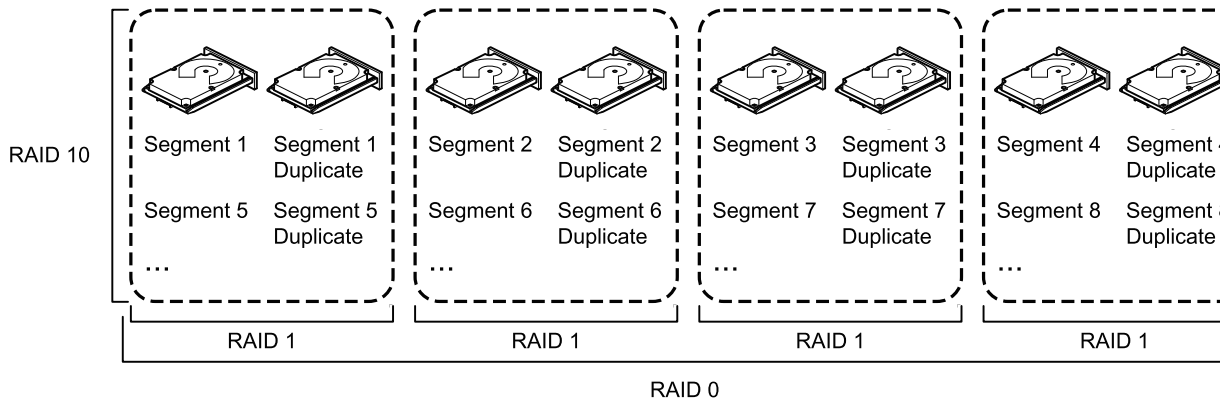

RAID 50

A RAID50 drive group provides the features of both RAID0 and RAID5 drive groups. A RAID50 drive group includes both distributed parity and drive striping across multiple drive groups. A RAID50 drive group is best implemented on two RAID5 drive groups with data striped across both drive groups.

A RAID50 drive group breaks up data into smaller blocks and then stripes the blocks of data to each RAID5 disk set. A RAID5 drive group breaks up data into smaller blocks, calculates parity by performing an exclusive OR operation on the blocks, and then performs write operations to the blocks of data and parity to each drive in the drive group. The size of each block is determined by the stripe size parameter, which is set during the creation of the RAID set.

A RAID level 50 drive group can support up to eight spans and tolerate up to eight drive failures, though less than total drive capacity is available. Though multiple drive failures can be tolerated, only one drive failure can be tolerated in each RAID 5 level drive group.

The following table provides an overview of a RAID50 drive group.

Uses	Appropriate when used with data that requires high reliability, high request rates, high data transfer, and medium-to-large capacity. Also used when a virtual drive of greater than 32 drives is needed.
Strong points	Provides high data throughput, data redundancy, and very good performance.
Weak points	Requires two times to eight times as many parity drives as a RAID 5 drive group.
Drives	Eight spans of RAID 5 drive groups that contain 3 to 32 drives each (limited by the maximum number of devices supported by the controller)

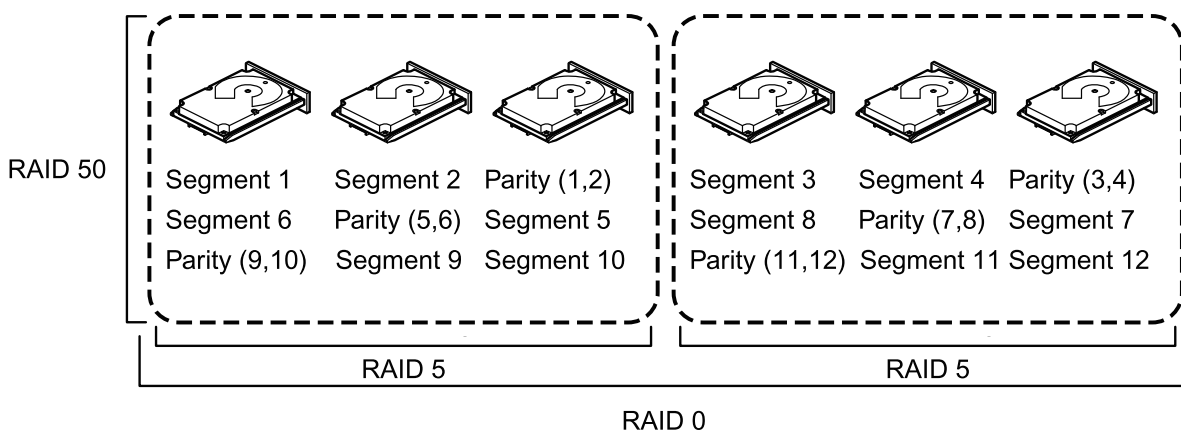

RAID 60

A RAID 60 drive group provides the features of both RAID 0 and RAID 6 drive groups, and includes both parity and disk striping across multiple drive groups. A RAID6 drive group supports two independent parity blocks per stripe. A RAID 60 virtual drive can survive the loss of two drives in each of the RAID6 drive group sets without losing data. A RAID60 drive group is best implemented on two RAID6 drive groups with data striped across both drive groups.

A RAID60 drive group breaks up data into smaller blocks and then stripes the blocks of data to each RAID6 disk set. A RAID6 drive group breaks up data into smaller blocks, calculates parity by performing an exclusive-OR operation on the blocks, and then performs write operations to the blocks of data and writes the parity to each drive in the drive group. The size of each block is determined by the stripe size parameter, which is set during the creation of the RAID set.

A RAID60 drive group can support up to 8 spans and tolerate up to 16 drive failures, though less than total drive capacity is available. Two drive failures can be tolerated in each RAID 6 level drive group.

Uses	<p>Provides a high level of data protection through the use of a second parity block in each stripe. Use a RAID60 drive group for data that requires a very high level of protection from loss.</p> <p>In the case of a failure of one drive or two drives in a RAID set in a virtual drive, the RAID controller uses the parity blocks to re-create all of the missing information. If two drives in a RAID 6 set in a RAID60 virtual drive fail, two drive Rebuild operations are required, one for each drive. These Rebuild operations can occur at the same time.</p> <p>Use for online customer service that requires fault tolerance. Use for any application that has high read request rates but low write request rates. Also used when a virtual drive of greater than 32 drives is needed.</p>
Strong points	<p>Provides data redundancy, high read rates, and good performance in most environments. Each RAID6 set can survive the loss of two drives or the loss of a drive while another drive is being rebuilt. Provides the highest level of protection against drive failures of all of the RAID levels.</p>
Weak points	<p>Not well-suited for small block write or random write operations. A RAID 60 virtual drive must generate two sets of parity data for each write operation, which results in a significant decrease in performance during write operations. Drive performance is reduced during a drive Rebuild operation. Environments with few processes do not perform as well because the RAID overhead is not offset by the performance gains in handling simultaneous processes.</p> <p>A RAID6 drive group costs more because of the extra capacity required by using two parity blocks per stripe.</p>
Drives	<p>A minimum of 6.</p>



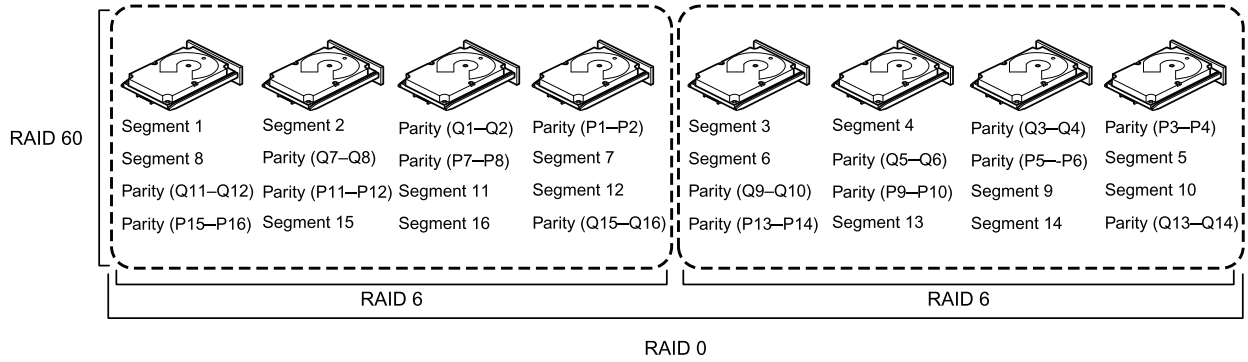

Note: Parity is distributed across all drives in the drive group.



To log in,

1. Enter the server's IP address and TCP port number (3443 as the default). If logging in from the server itself, you can select the Local station checkbox.
2. Enter the credentials for login. The credentials were created during the installation.
3. You can use an existing AD account for login. See page 245 for user management and AD account configuration.
4. Auto login: After you enter the credentials for the first time, the server will not prompt for credentials the next time you start the VSS software.



Introducing VSS

VIVOTEK VSS (VAST Security Station) is the professional video / central management software designed for managing all VIVOTEK IP surveillance products with intuitive functions and numerous features. It supports hundreds of cameras and stations in a hierarchical structure of system for monitoring, recording, playback and event trigger management with ease-of-use and efficient control.

VSS integrates VIVOTEK network cameras to provide diverse solutions and applications, with the cameras for uninterrupted video recording, Smart Search II, Smart VCA, and Cybersecurity management solution. VSS performs remote management with full range of the server & client structure and constitutes a robust system for various applications, such as stores, banking and the public space.

Key Features

- Deep Search with attributes, scenes, and Re-search functions
- Smart Search II Plus: Dynamic Forensic Search
 - Line Crossing: Detection of crossing a user-defined line and direction
 - Loitering: Detection of Loitering in an area for a configurable stay time.
 - Intrusion: Detection of intrusion into a zone or leaving from a zone.
- Smart Tracking: Speed Dome's People Tracking.
- Live Multicast: Reduced network traffic and optimized bandwidth usage.
- CMS Failover: 1+1 redundancy for Central Management server.
- Data Overlay on screen.
- User defined role for group authorities
- Recording encryption
- Managed PoE Switch integration



- License plate recognition solution and data magnet
- Cybersecurity Management Solution
- Smart VCA: AI Powered Video Analytics
- System Overview dashboard
- Multi-sensor display modes
- Evidence Lock: Automatically Bookmark Related Recordings When Alarm Triggered.
- Evidence Export: Manually Export Video Recordings or Alarm Clips.
- Matrix for Video Wall Solution
- Automatic Problem Feedback Mechanism
- Multiple Fisheye Dewarp Modes



Installing VSS

1. Run the vss_setup_version_(x64).exe on your computer.
2. Read the license agreement carefully and click "I agree" to initiate the installation process.

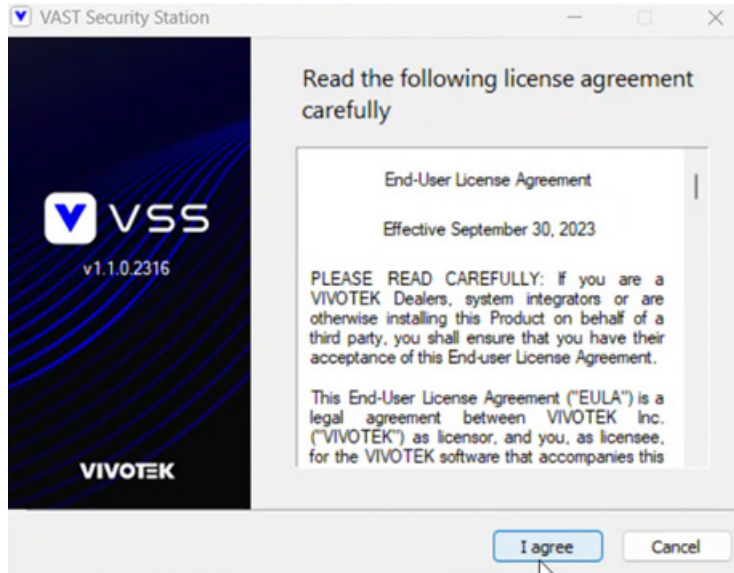

3. Select the programs you want to install, then click "Next" to continue. Refer to the "Installation Option" section for more information on the "Server with OpenVPN" option.

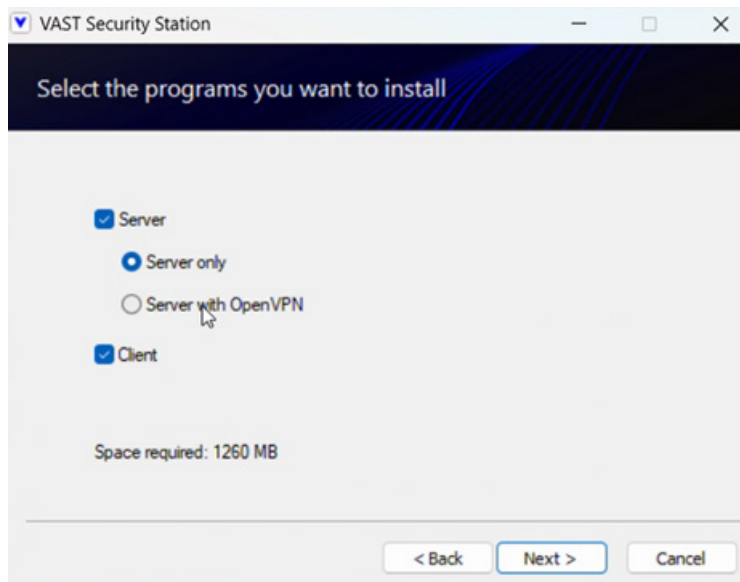

4. Select the server type you want to install, then click "Next" to continue. Your first installation of a standard server includes a 60-day trial of the VSS Pro edition, and you will need to purchase the official software licenses for continued use after the trial expires.



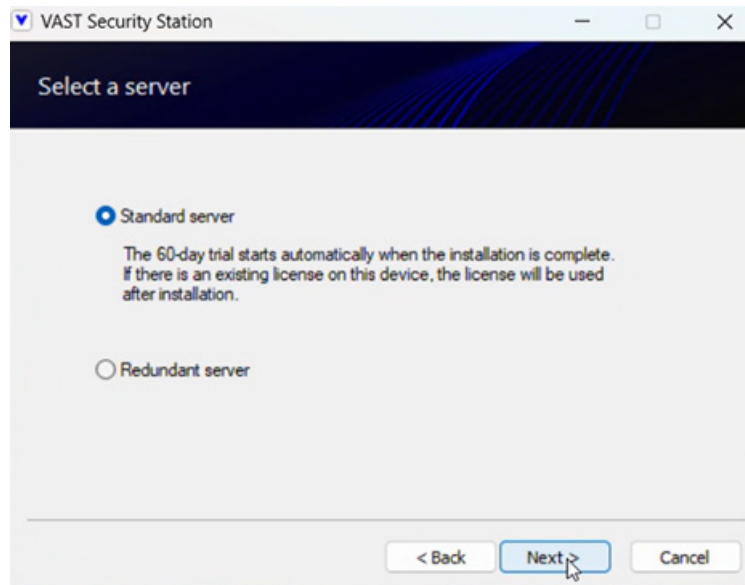

5. Create an administrator account.

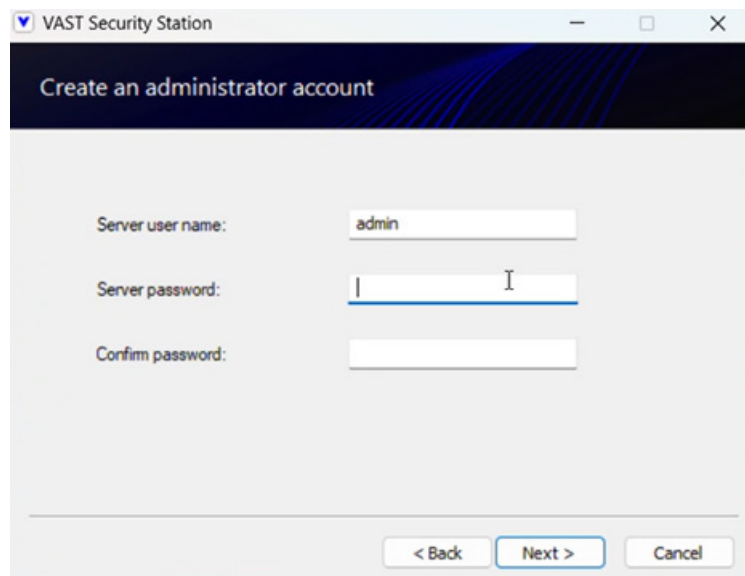

6. Set up the name and the default storage path for recording and database.

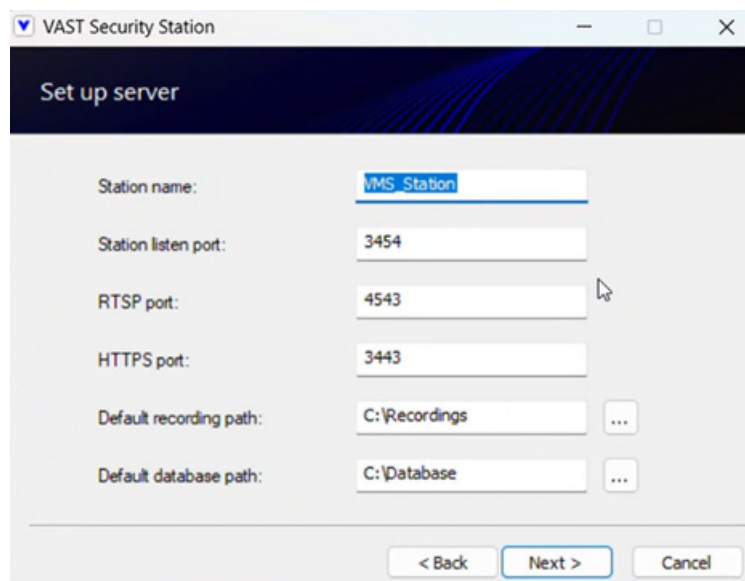

7. Choose whether to enable VSS to utilize and store person attributes and full-body/face images for improved people search. If you prefer to exclude face snapshots, uncheck the “Utilize and store face snapshots” checkbox. This setting can also be modified on the VSS client setting page after installation.

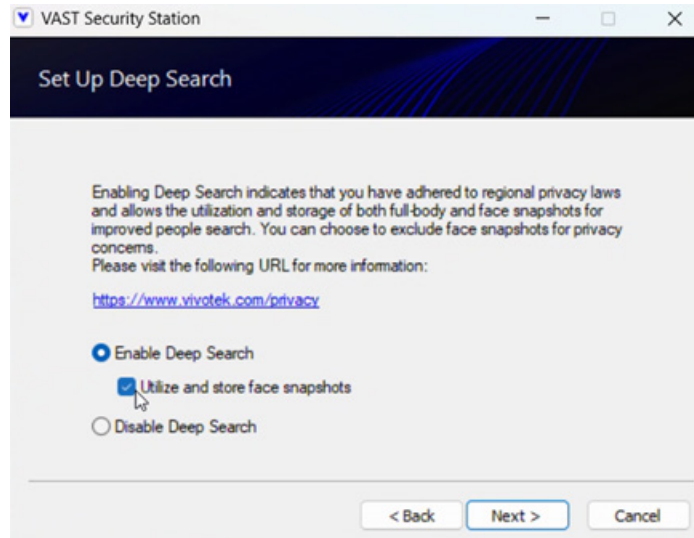

8. Specify a location to install the software, then click “Install”.

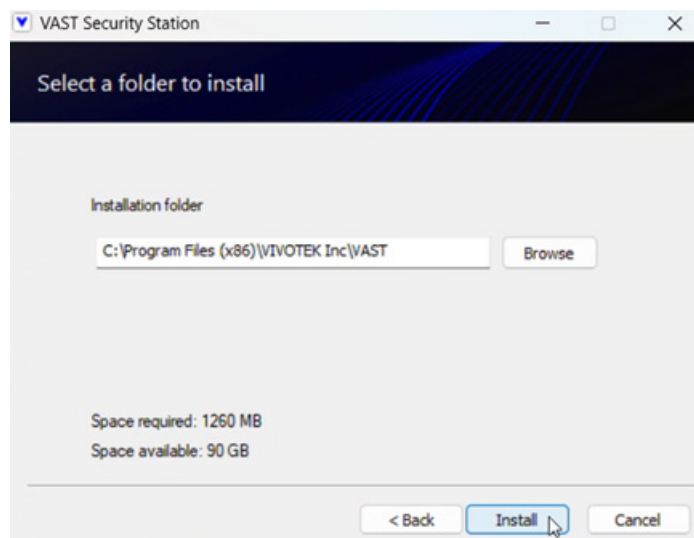

9. Wait for the installation process to complete, then click “Close” to exit the installation process.

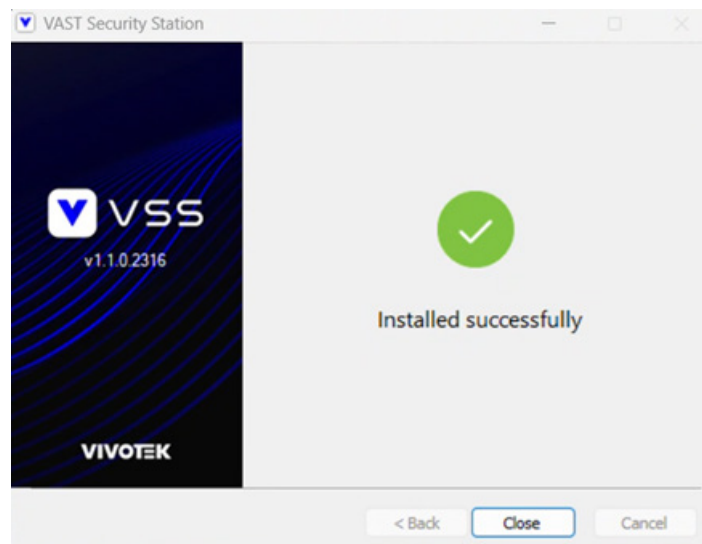

Installation Option

NAT-traversal with OpenVPN

A remote connection between a VSS server and an NVR with 3G/4G/LTE network can be made through an OpenVPN tunnel. The figure below shows the methodology comprising HMAC authentication and TLS encryption over an encrypted UDP connection.

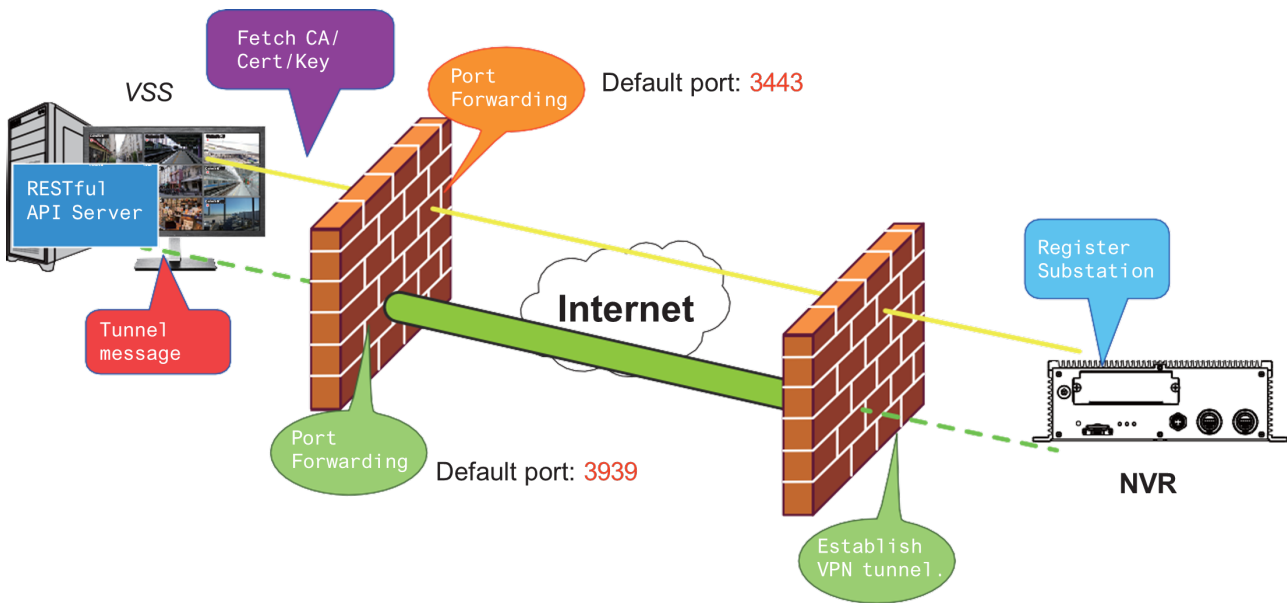

Sample installation steps are shown below:

Step 1: Install VSS by selecting the Server with OpenVPN option.

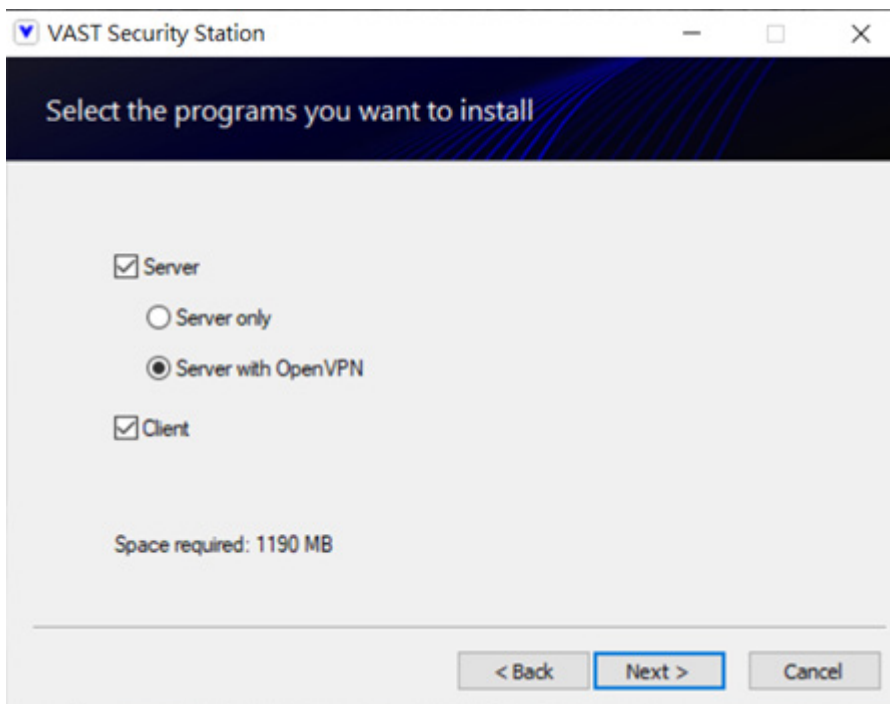

Step 2: Enable the public IP of the VSS Server.

For the NVR to establish an OpenVPN connection with the VSS Server, the user must activate the public IP of that server. (Note that the specific steps depend on the user's network environment and relevant IT policies.)

After activating the Public IP, ensure the accessibility of the HTTPS port and OpenVPN port. (Note that the VSS OpenVPN port by default is 3939, so the user must set up port forwarding with UDP.)

If the default HTTPS port (3443) is unavailable, the user must modify the corresponding port number under VSS Settings > Device > Stations. If the default port for OpenVPN (3939) is not available, the user needs to modify the configuration file of OpenVPN (located in C:\Program Files (x86)\VIVOTEK Inc\VAST\Server\OpenVPN\config\server\server.ovpn).

You can directly edit the port number in this text file (file content is shown below):

```
port 3939
proto udp
dev tun
ca ca.crt
cert server.crt
key server.key
dh dh.pem
server 10.6.0.0 255.255.0.0
topology subnet
client-to-client
client-config-dir "C:\\Program Files (x86)\\VIVOTEK Inc\\VAST\\Server\\OpenVPN\\ccd"
keepalive 10 120
cipher AES-256-CBC
max-clients 50000
persist-key
persist-tun
status openvpn-status.log
log-append openvpn.log
verb 3
mute 20
sndbuf 262144
rcvbuf 262144
tls-server
compress lzo
```



Step 3: Configure the NVR OpenVPN connection.

Once you have obtained the VSS Server public IP, configure the NVR settings under Network > Service > CMS. Then, enter the VSS server public IP/credentials/API service port (HTTPS). (Note that if the HTTPS port on the VSS end is not 3443, you must modify the corresponding port number.)

After configuring the settings for VSS and NVR, the OpenVPN connection will be established. Once the connection is established, this NVR will be automatically added to the VSS server. (Note that the NVR and VSS servers should have a similar time setting when exchanging certificate information. Otherwise, the mutual handshake authentication process may fail.)

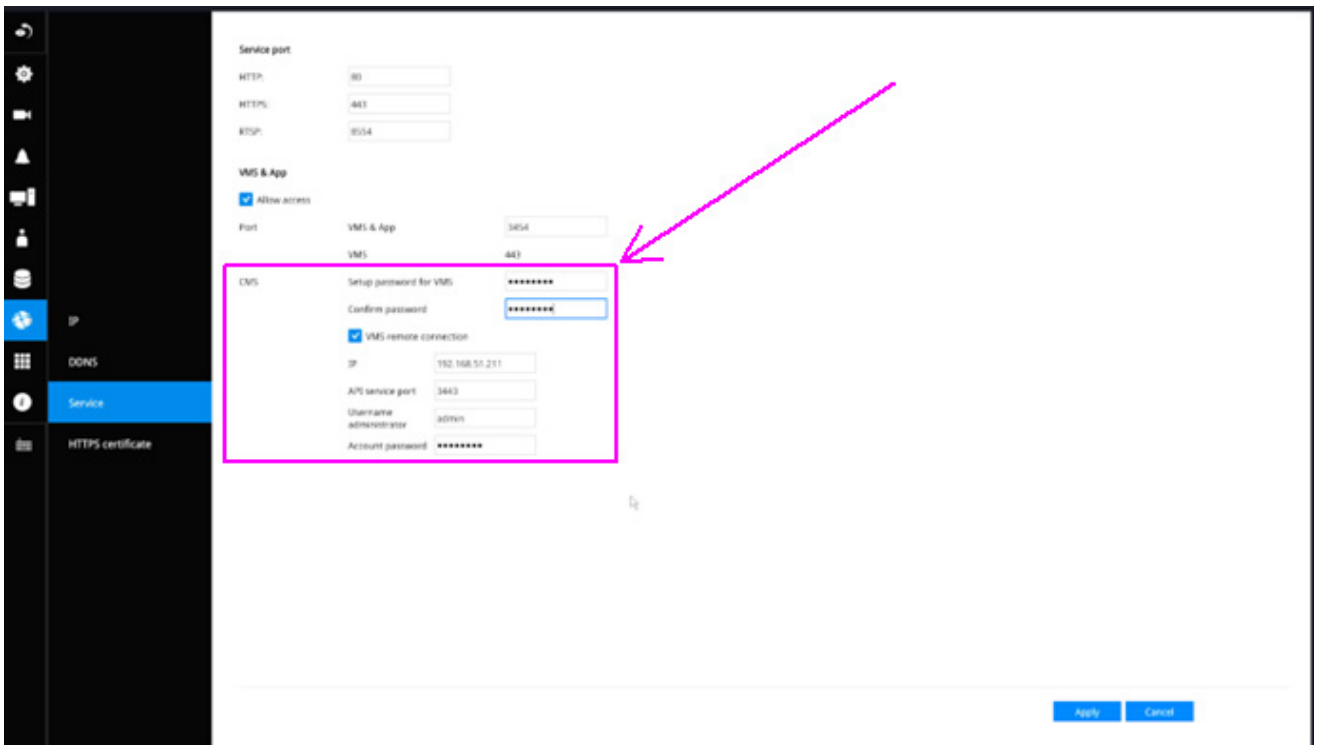



Chapter 1 Basics:

Control and Elements

The basic screen elements of VSS live view, playback, and search panel are shown below:

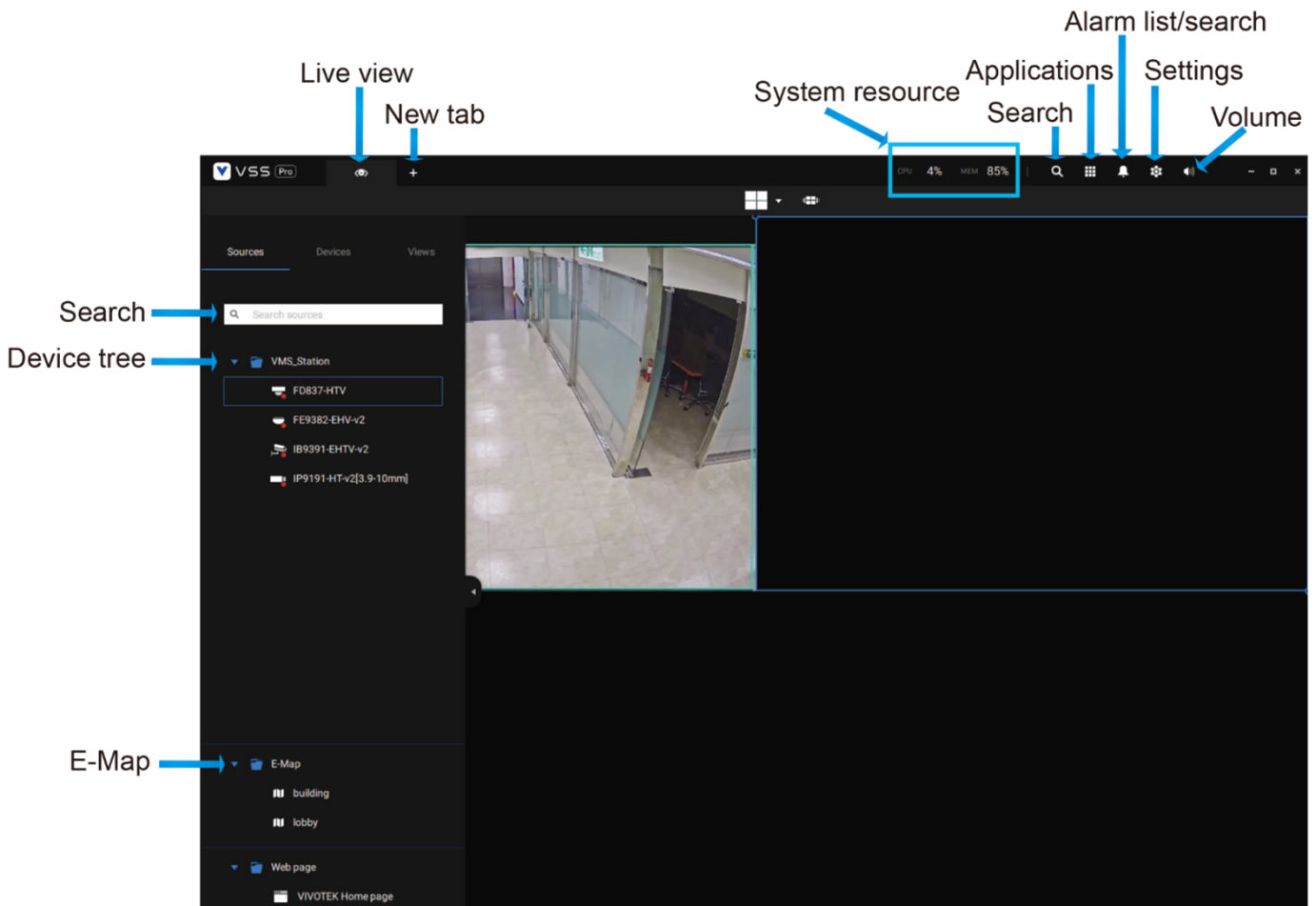
Live view



Playback is evoked when a view cell is selected, and you click the Playback button  on the upper right of the view cell.



Search Panel

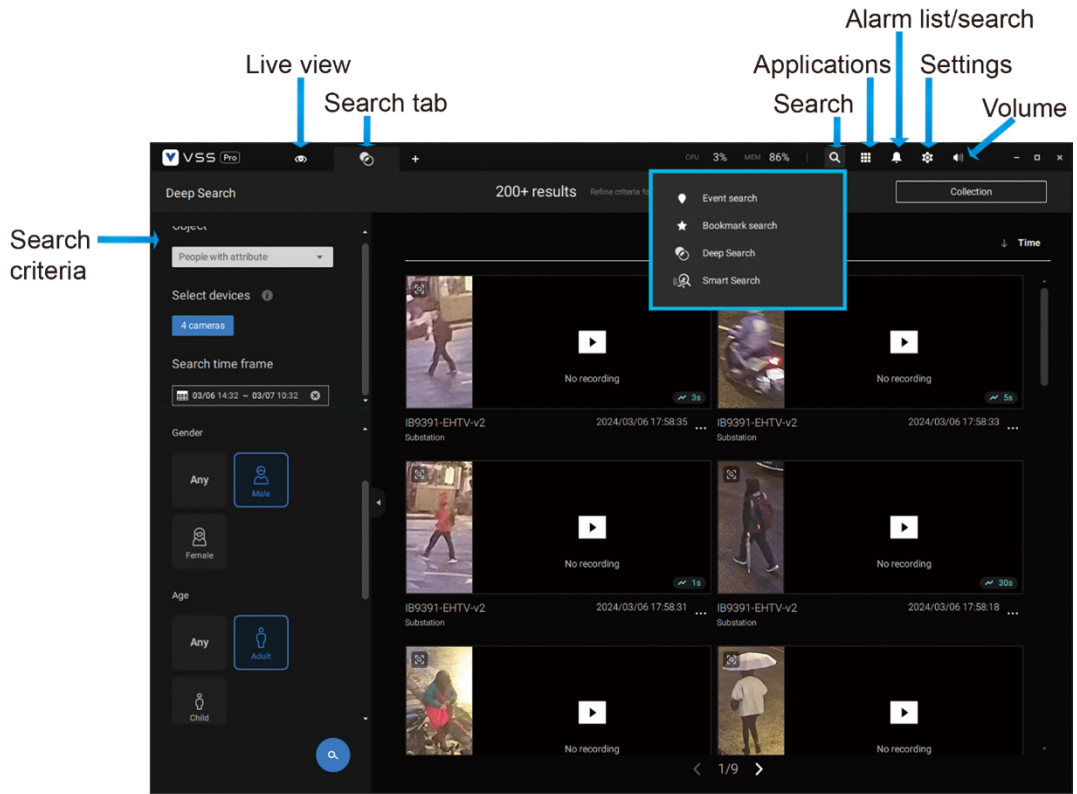

Playback Control

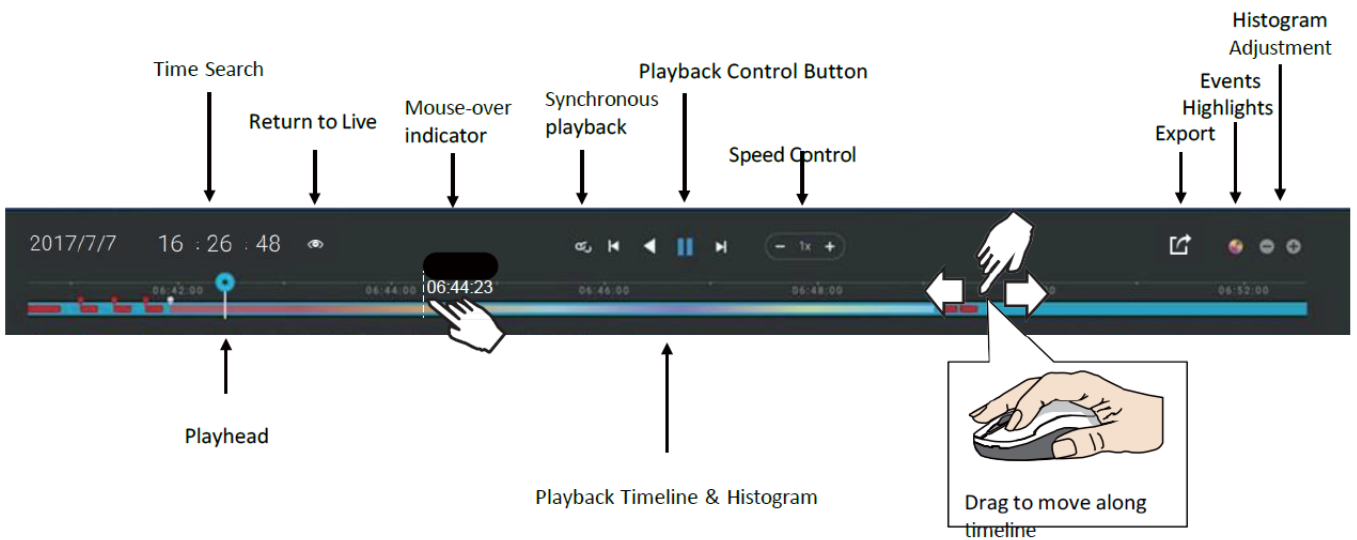

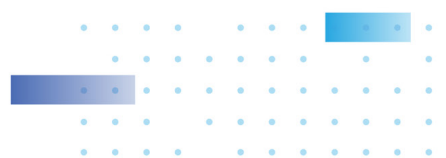
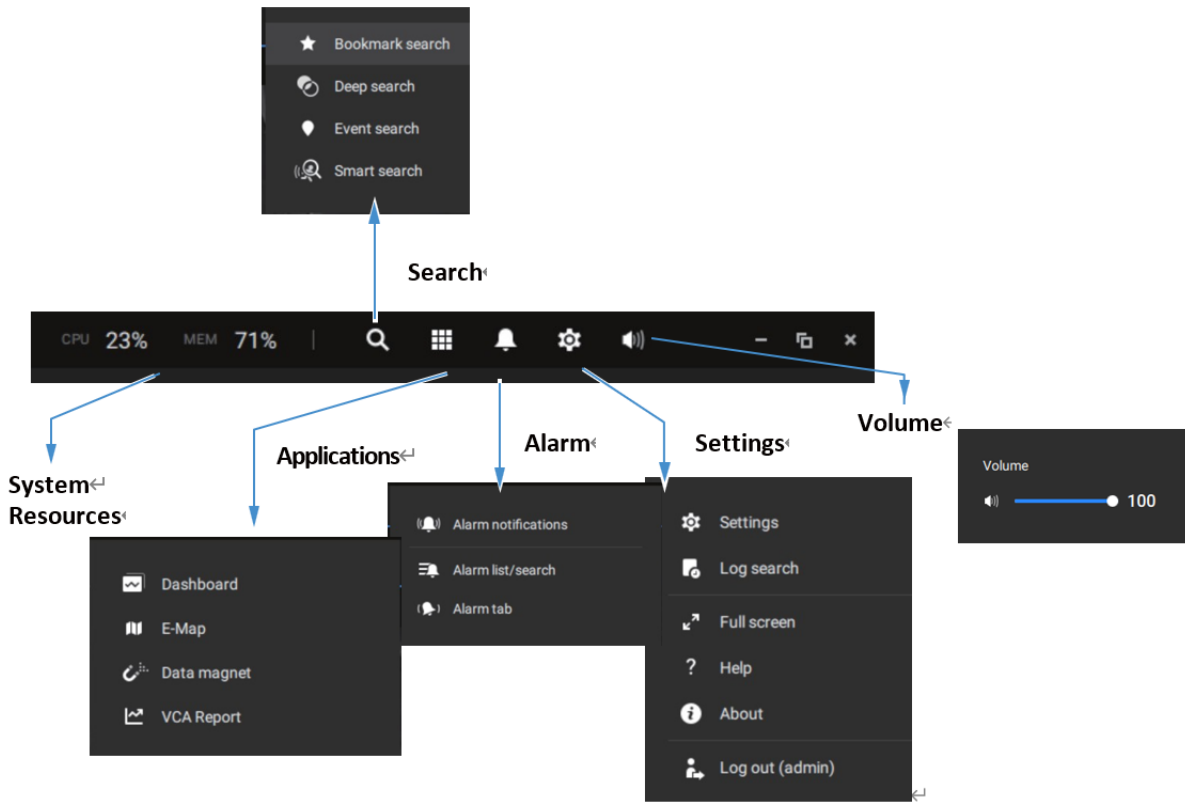

View cell control

Some controls and functions are available when a view cell is selected or via the right-click menus.

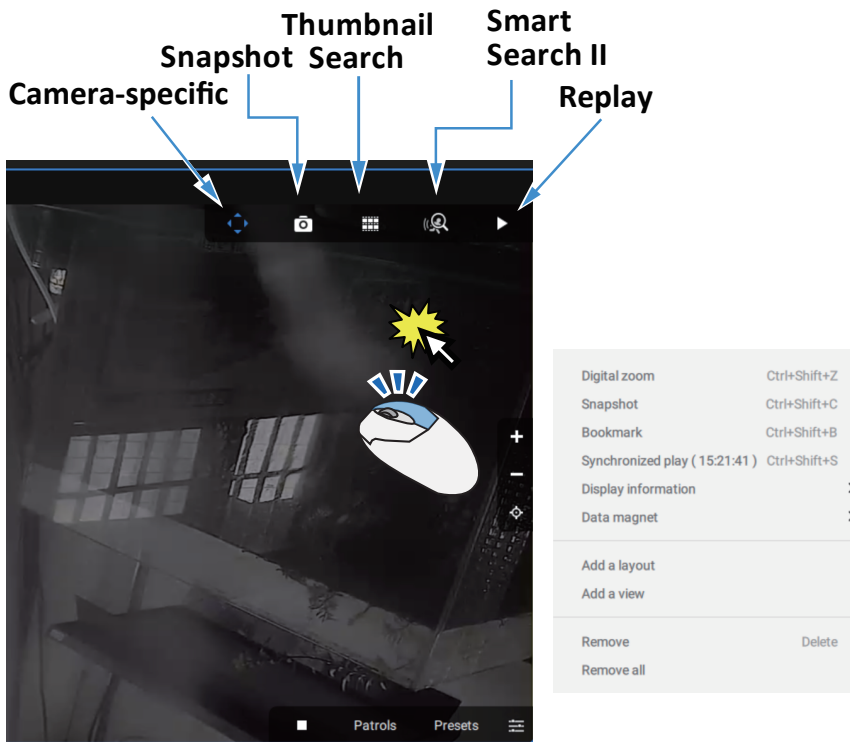

Text overlay

Single-click to select a view cell, right-click and select Display information. The Edit display information tab will appear.

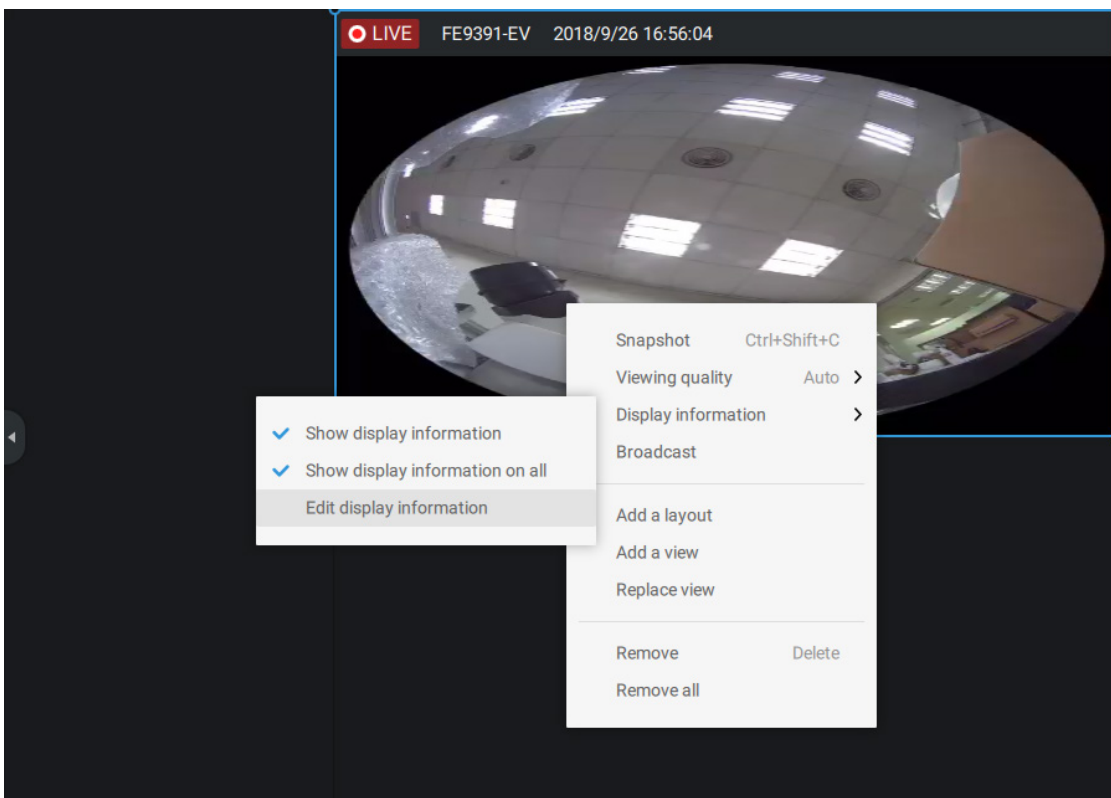

Select the checkboxes to determine what kind of text overlay will display on view cells. Note that you can place the overlay either on top or at the lower screen. Simply click and drag an overlay item to a preferred location. When done, click the Apply button.

You can apply your current configuration to all view cells by selecting the Apply to all view cells checkbox. Note that you can also display the VCA rules and areas on screen.

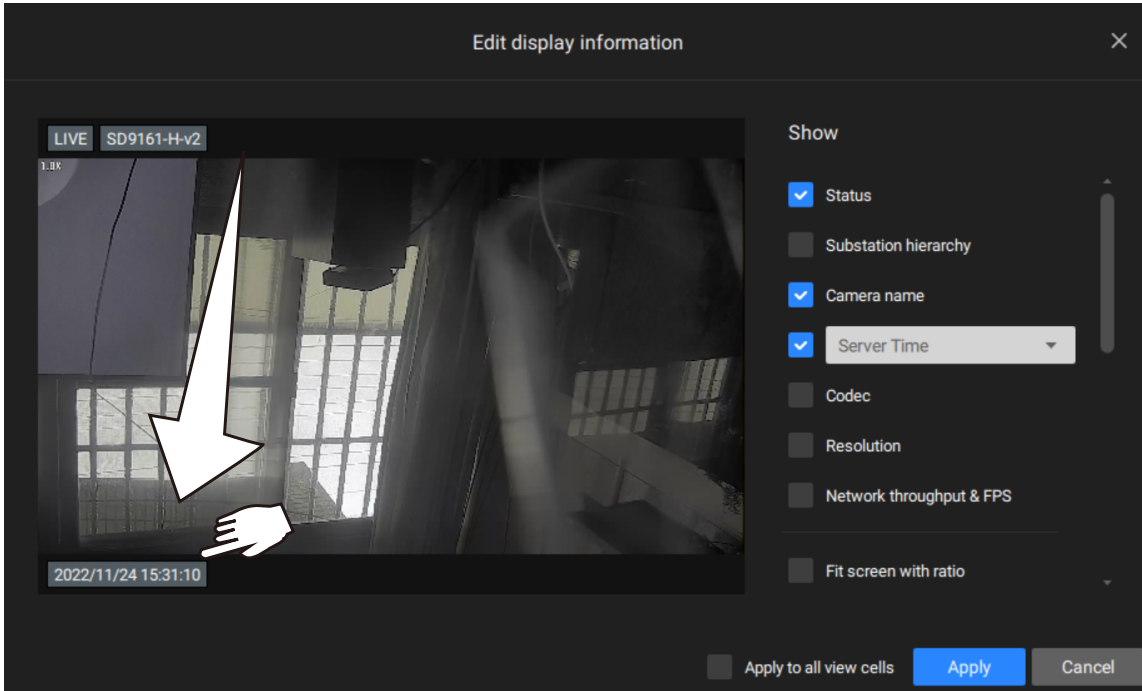

Two Way Audio

If your cameras support the Two Way Audio feature and the microphone and audio output to an amplified speakers have been connected, you can right-click on the camera to display the Broadcast function. Click on the Microphone icon in the middle to start speaking. Click again to stop the Two Way Audio.

Note that the Broadcast option only appears when you select a camera that supports the Two Way Audio feature. Currently the VSS software supports 1 to 1 broadcast.

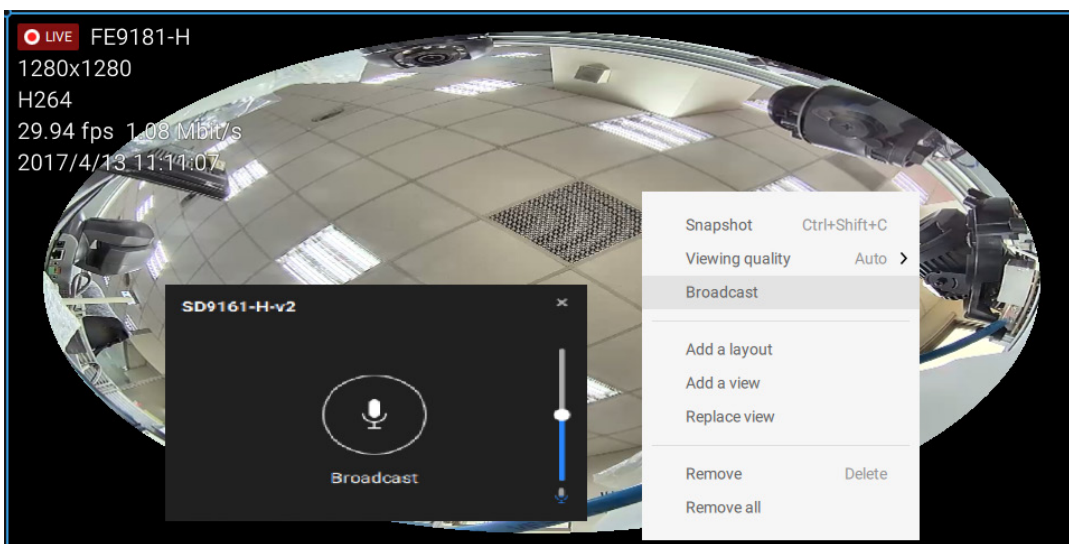

The full screen function maximizes the display of view cells, concealing all other tool bar or navigation panels. To return to the normal view, press the ESC key on keyboard.

Log Search

System logs can be found via the tool bar tab. All system events will be listed in the Log search panel. If you have multiple server, substations, select a server. You can search specific events by the event types (All triggers, camera, system/station, external devices), or by the time of occurrence using the calendar tool.

Use the Export button  to export the system log as an individual log file.

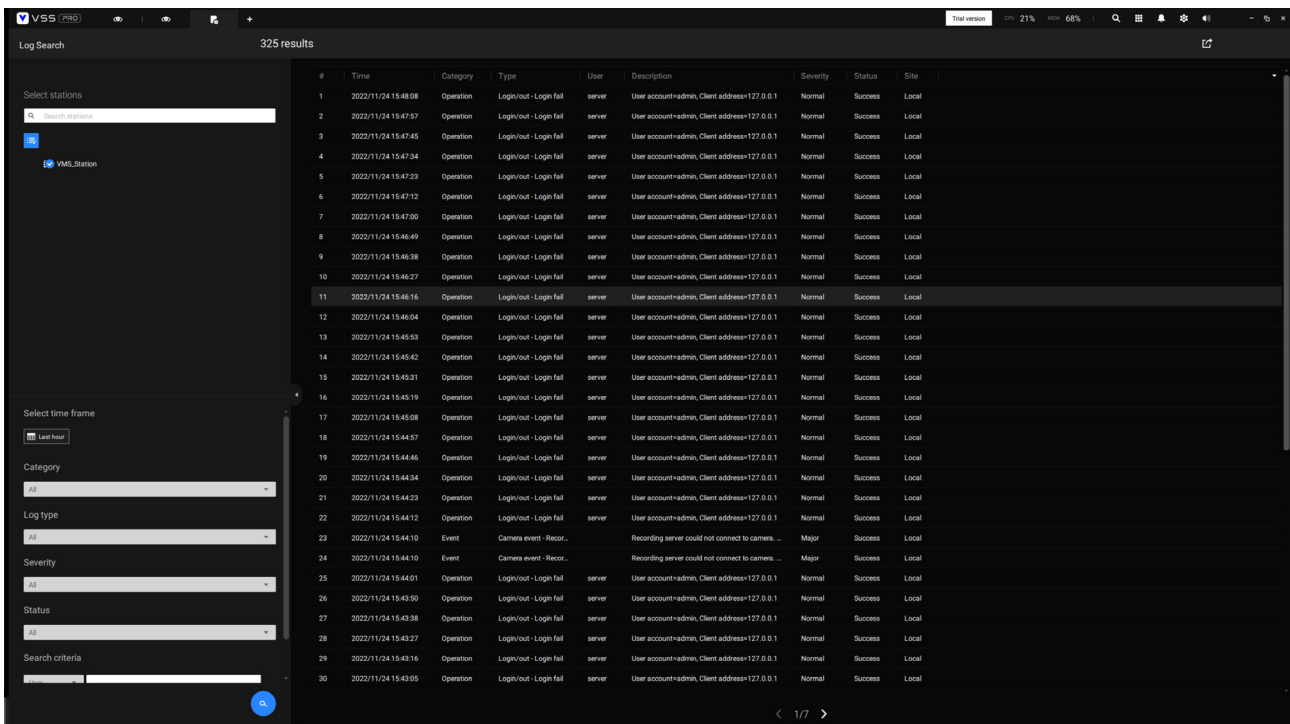

#	Time	Category	Type	User	Description	Severity	Status	Site
1	2022/11/24 15:48:08	Operation	Login/out - Login fail	server	User account-admin, Client address+127.0.0.1	Normal	Success	Local
2	2022/11/24 15:47:57	Operation	Login/out - Login fail	server	User account-admin, Client address+127.0.0.1	Normal	Success	Local
3	2022/11/24 15:47:45	Operation	Login/out - Login fail	server	User account-admin, Client address+127.0.0.1	Normal	Success	Local
4	2022/11/24 15:47:34	Operation	Login/out - Login fail	server	User account-admin, Client address+127.0.0.1	Normal	Success	Local
5	2022/11/24 15:47:23	Operation	Login/out - Login fail	server	User account-admin, Client address+127.0.0.1	Normal	Success	Local
6	2022/11/24 15:47:12	Operation	Login/out - Login fail	server	User account-admin, Client address+127.0.0.1	Normal	Success	Local
7	2022/11/24 15:47:00	Operation	Login/out - Login fail	server	User account-admin, Client address+127.0.0.1	Normal	Success	Local
8	2022/11/24 15:46:49	Operation	Login/out - Login fail	server	User account-admin, Client address+127.0.0.1	Normal	Success	Local
9	2022/11/24 15:46:38	Operation	Login/out - Login fail	server	User account-admin, Client address+127.0.0.1	Normal	Success	Local
10	2022/11/24 15:46:27	Operation	Login/out - Login fail	server	User account-admin, Client address+127.0.0.1	Normal	Success	Local
11	2022/11/24 15:46:16	Operation	Login/out - Login fail	server	User account-admin, Client address+127.0.0.1	Normal	Success	Local
12	2022/11/24 15:46:04	Operation	Login/out - Login fail	server	User account-admin, Client address+127.0.0.1	Normal	Success	Local
13	2022/11/24 15:45:53	Operation	Login/out - Login fail	server	User account-admin, Client address+127.0.0.1	Normal	Success	Local
14	2022/11/24 15:45:42	Operation	Login/out - Login fail	server	User account-admin, Client address+127.0.0.1	Normal	Success	Local
15	2022/11/24 15:45:31	Operation	Login/out - Login fail	server	User account-admin, Client address+127.0.0.1	Normal	Success	Local
16	2022/11/24 15:45:19	Operation	Login/out - Login fail	server	User account-admin, Client address+127.0.0.1	Normal	Success	Local
17	2022/11/24 15:45:08	Operation	Login/out - Login fail	server	User account-admin, Client address+127.0.0.1	Normal	Success	Local
18	2022/11/24 15:44:57	Operation	Login/out - Login fail	server	User account-admin, Client address+127.0.0.1	Normal	Success	Local
19	2022/11/24 15:44:46	Operation	Login/out - Login fail	server	User account-admin, Client address+127.0.0.1	Normal	Success	Local
20	2022/11/24 15:44:34	Operation	Login/out - Login fail	server	User account-admin, Client address+127.0.0.1	Normal	Success	Local
21	2022/11/24 15:44:23	Operation	Login/out - Login fail	server	User account-admin, Client address+127.0.0.1	Normal	Success	Local
22	2022/11/24 15:44:12	Operation	Login/out - Login fail	server	User account-admin, Client address+127.0.0.1	Normal	Success	Local
23	2022/11/24 15:44:10	Event	Camera event - Recor...		Recording server could not connect to camera ...	Major	Success	Local
24	2022/11/24 15:44:10	Event	Camera event - Recor...		Recording server could not connect to camera ...	Major	Success	Local
25	2022/11/24 15:44:01	Operation	Login/out - Login fail	server	User account-admin, Client address+127.0.0.1	Normal	Success	Local
26	2022/11/24 15:43:50	Operation	Login/out - Login fail	server	User account-admin, Client address+127.0.0.1	Normal	Success	Local
27	2022/11/24 15:43:38	Operation	Login/out - Login fail	server	User account-admin, Client address+127.0.0.1	Normal	Success	Local
28	2022/11/24 15:43:27	Operation	Login/out - Login fail	server	User account-admin, Client address+127.0.0.1	Normal	Success	Local
29	2022/11/24 15:43:16	Operation	Login/out - Login fail	server	User account-admin, Client address+127.0.0.1	Normal	Success	Local
30	2022/11/24 15:43:05	Operation	Login/out - Login fail	server	User account-admin, Client address+127.0.0.1	Normal	Success	Local

Alarm list

The Alarm list is accessed from the top tool bar. The Alarm list provides easy access to all triggered alarms, such as tampering alarms, alarms reported by VCA analytics, external devices connected via a camera's DI pin, etc.

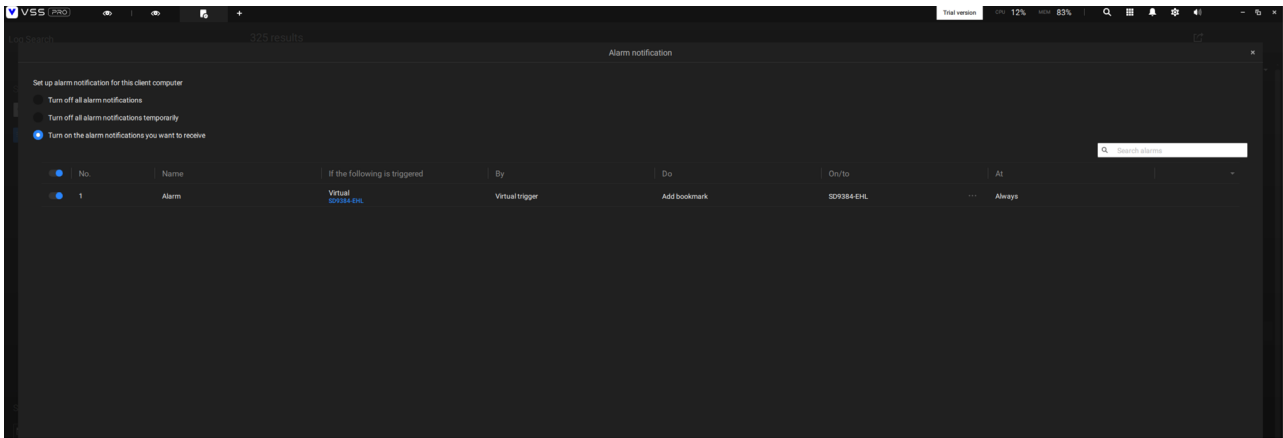
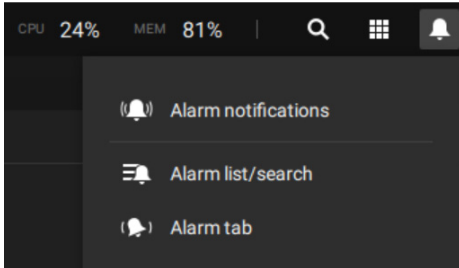

The Alarm list can be displayed in either the List view or Thumbnail view.

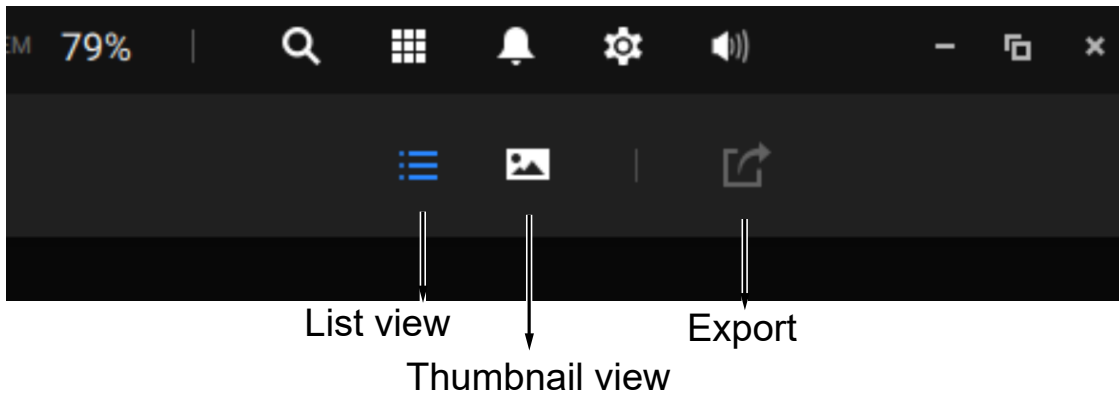

Below is an example of a Thumbnail view.

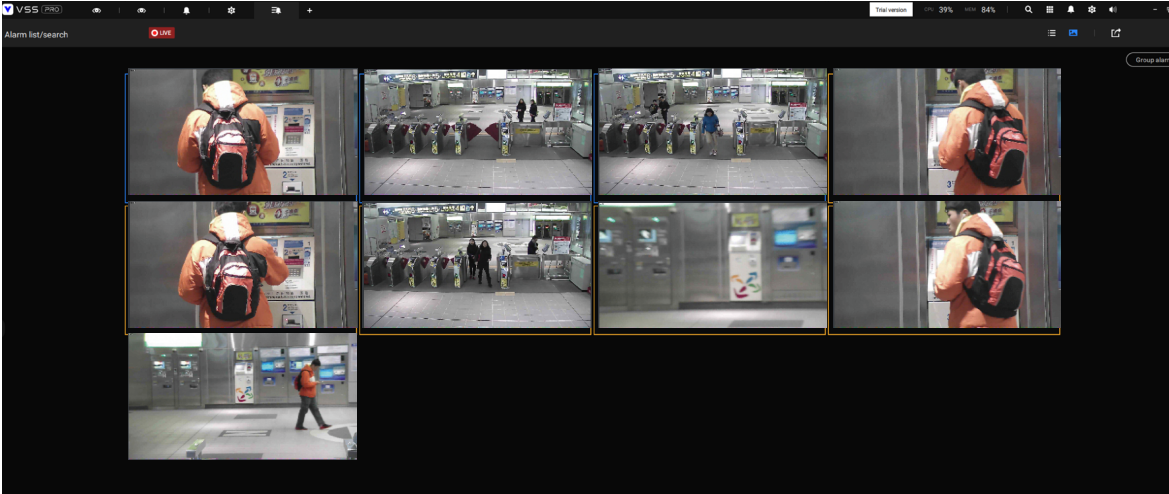

On the Alarm list, you can double-click to select a triggered alarm. A related snapshot and configuration panel will appear. An operator can select the Status menu to change the event management status. The configurable statuses can be:

1. **New:** An event that has not been handled.
2. **In progress:** Select to indicate that the event is being handled, e.g., a security personnel has been sent to verify the cause of the event.
3. **False alarm:** Used to indicate the event has been verified as a false alarm.
4. **Close:** A closed case event will be erased from the event list.

When done with designating event status, click the **Acknowledgment** button.

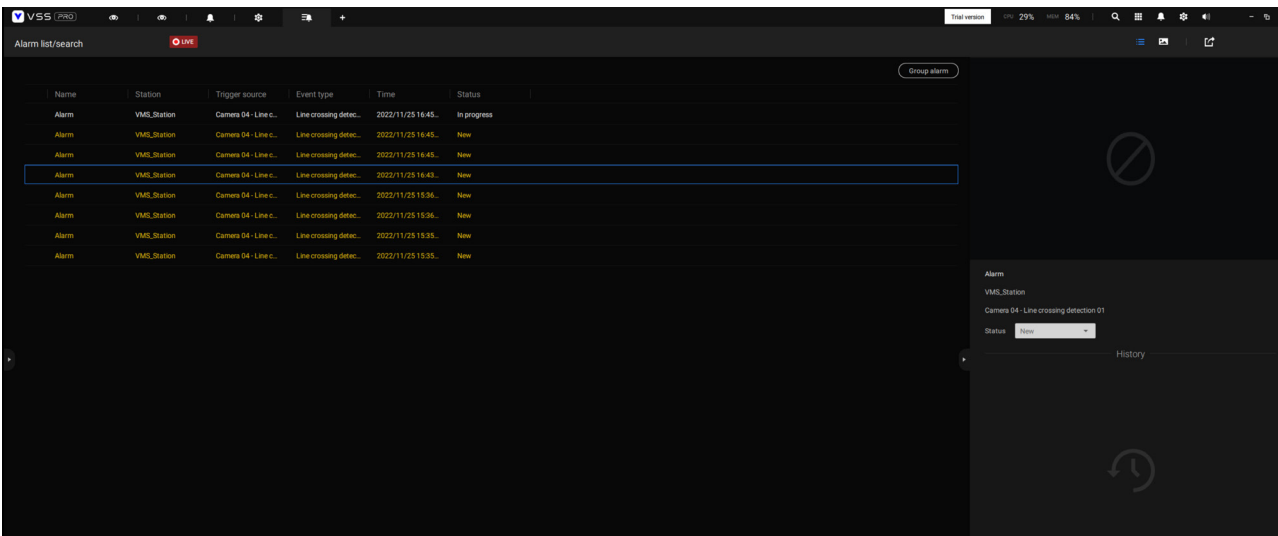

The Alarm list also supports Hot keys.

Alarm list window			
Mute the current alarm	Ctrl		m
Designate the selected alarms as false alarms	Ctrl		f
Select all alarms	Ctrl		a
Select one or multiple alarms	Ctrl		left mouse button
Select multiple alarms		Shift	left mouse button
Select different alarms			Up/Down/Left/Right

When an alarm is muted, a message will prompt asking for how long the alarm will be muted. Enter a number, and the alarm will disappear from the list temporarily.

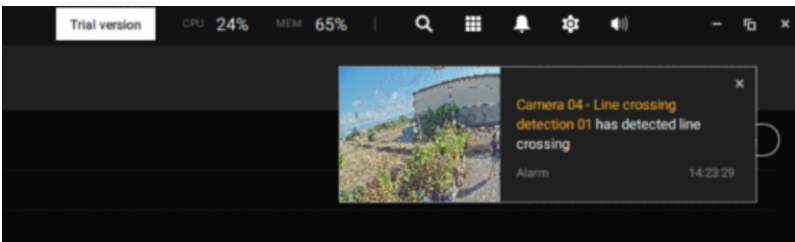

When an alarm is designated as a false alarm, it is immediately removed from the list.

When an alarm is designated as In progress, you can add a comment on the current condition, and click Acknowledge to change its status.

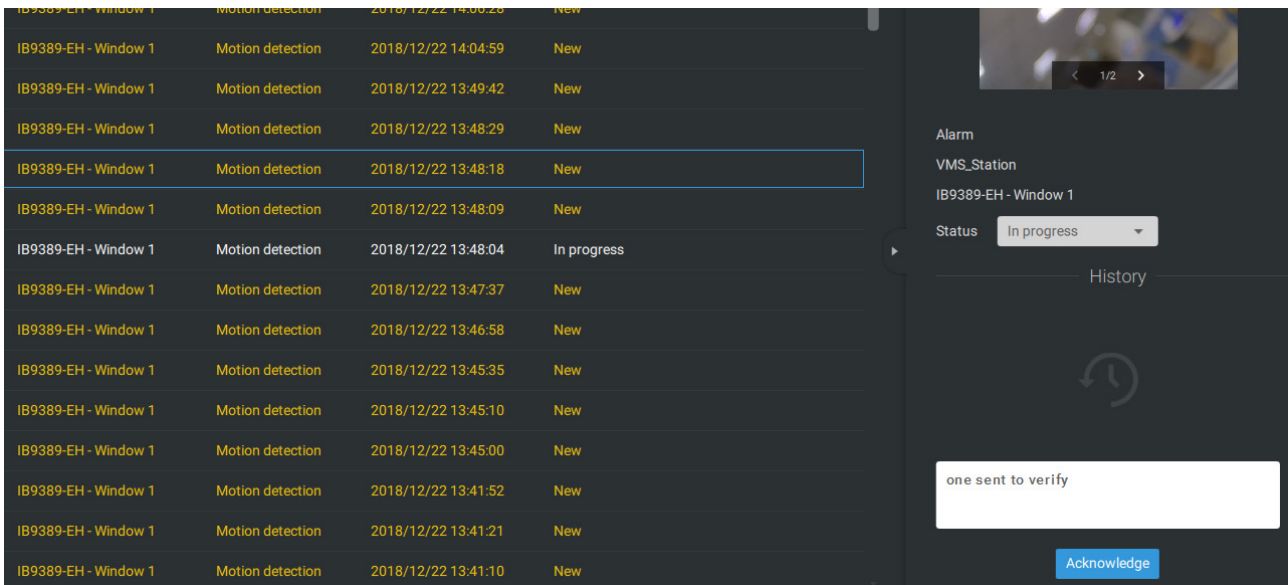

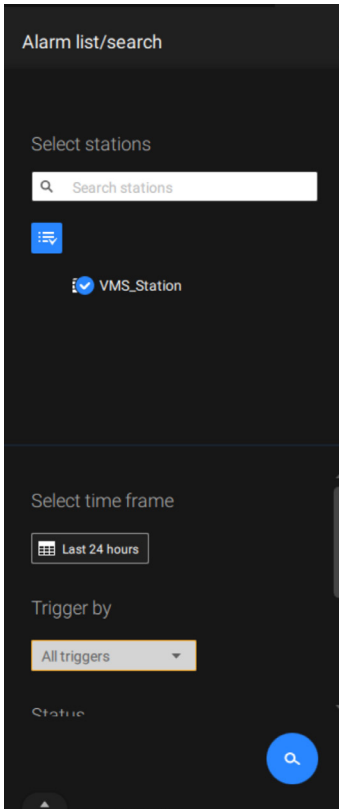

To find alarms of specific types, time of occurrences, and alarm status, click the side tab to reveal the search panel.

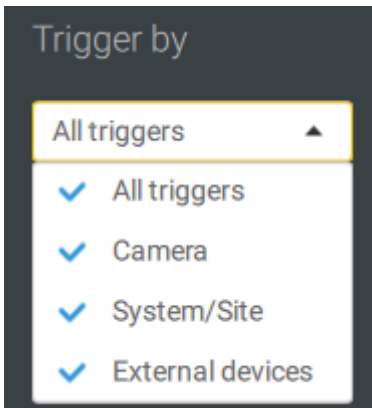

You can select the trigger source, e.g., when you need to see camera alarms only.

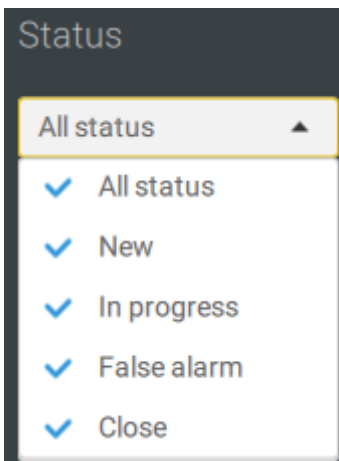

You can check to see alarms of a specific status. For example, you can select to search for the "In progress" alarms only.

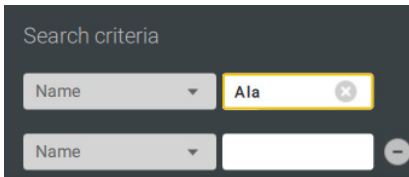

A screenshot of a search interface with a dark background. At the top, it says "Search criteria". Below that are two rows of input fields. The first row has a dropdown menu labeled "Name" and a text input field containing "Ala" with a clear button (an 'x' in a circle) to its right. The second row also has a dropdown menu labeled "Name" and an empty text input field with a clear button to its right.

You can enter one or multiple keywords as the search criteria.

For example, if you have an alarm named as "Alarm3-sidewalk," use the name as the keyword to search for the related alarms.

You can use the Export button  to export a full list of all triggered events into a CSV file. The event type, receiving station, triggering device, time of occurrence, and event status will all be listed. You can also export alarm-triggered videos.

You can also add a comment for an event by entering the description in the comment entry field.



To review the alarm-related video, click to select an alarm, double-click to playback. The Playback window will appear on the upper right of the screen.

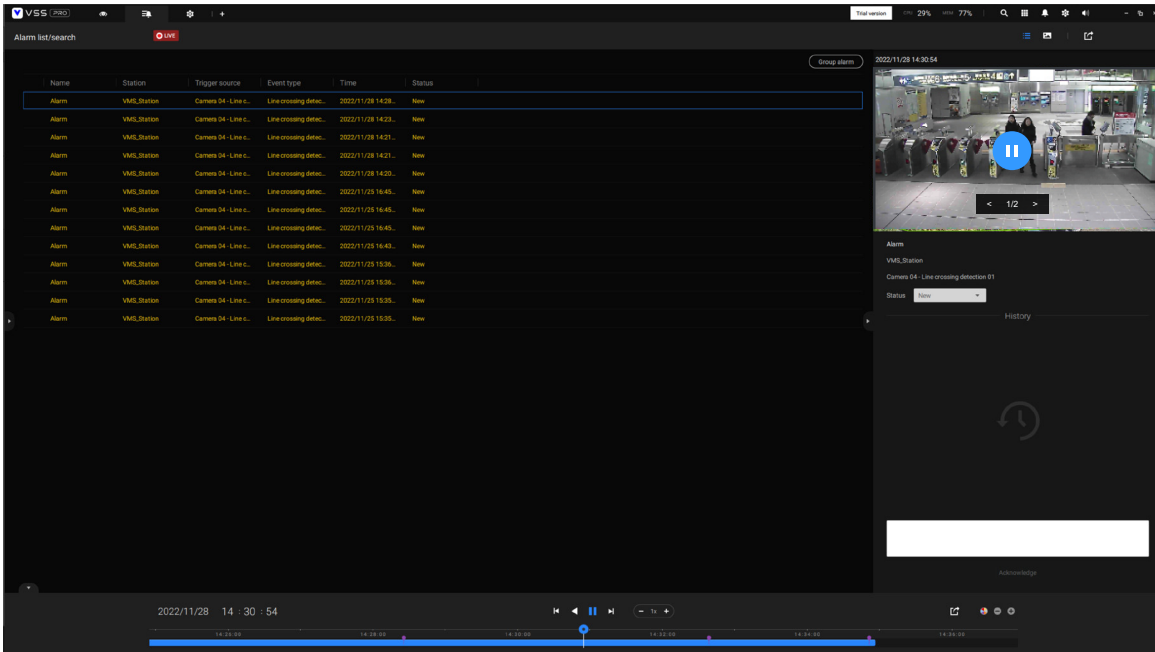

Double-click on the small playback screen again to bring it to the full view. The playback control, time line, export, and alarm tags will be available on screen.

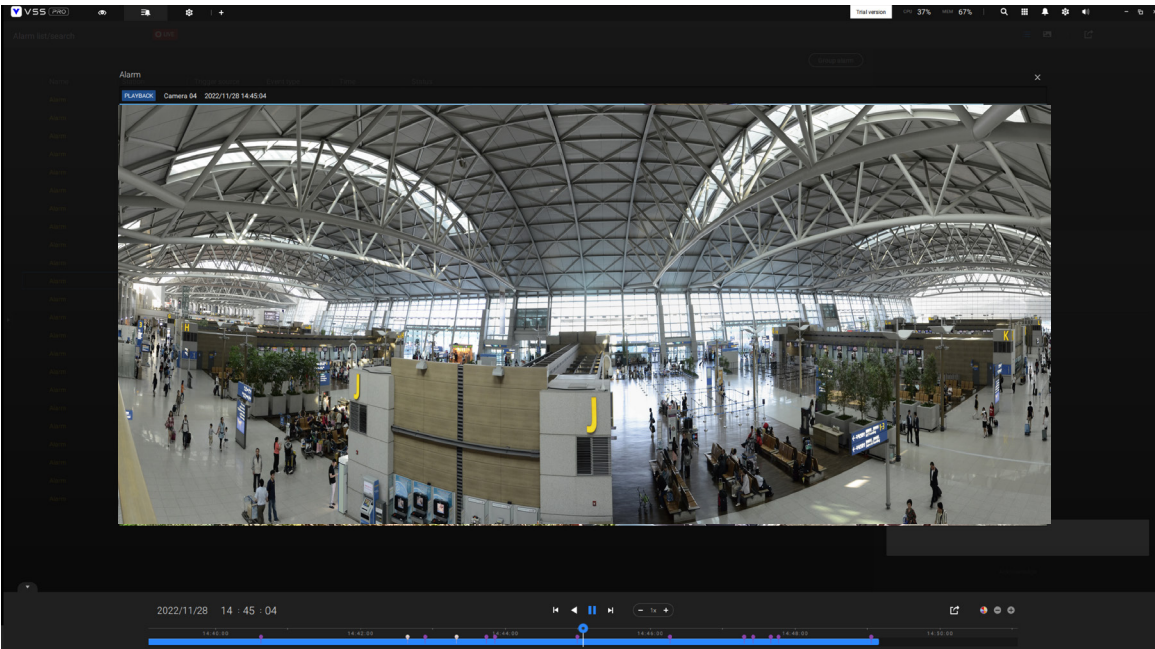

Alarm tab

The Alarm tab is an automated streaming window displaying live videos brought by the triggered alarms. If you configure an alarm action as "[Send live streaming](#)," the alarm streaming will be displayed in this window. Note that this window does not display other types of alarms.

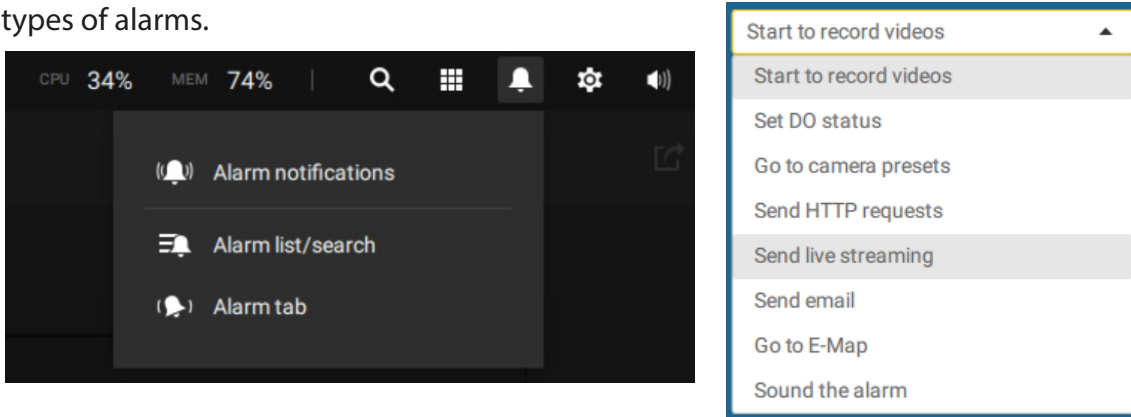

When a live streaming is sent by an alarm, an orange ringing bell icon will display.

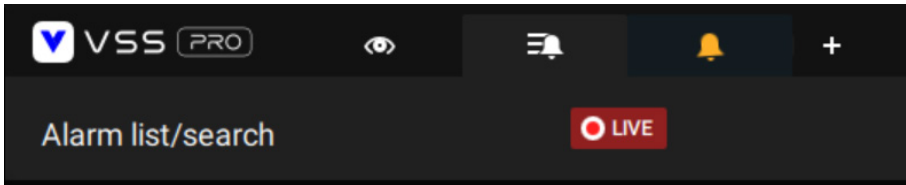

An alarm prompt will also display on the screen.

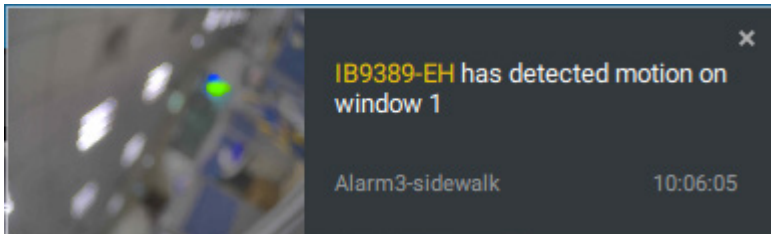

You can click on the ringing bell icon to open the Alarm tab window. The alarm-triggered streamings will be available on screen.



Hot Keys

Open online document			F1
Close current tab	Ctrl (Win) / Command (MacOS)		W
Open new Live / Playback tab	Ctrl (Win) / Command (MacOS)		T
Full screen	Ctrl (Win) / Command (MacOS)	Shift	F
Exit full screen	Ctrl (Win) / Command (MacOS)	Shift	F
Exit full screen			Esc
View cell			
Select view cell			Arrow keys
Digital zoom	Ctrl (Win) / Command (MacOS)	Shift	Z
Snapshot	Ctrl (Win) / Command (MacOS)	Shift	C
Instant bookmark	Ctrl (Win) / Command (MacOS)	Shift	B
Remove camera from cell			Del
Move to preset position	Ctrl (Win) / Command (MacOS)		Digits (1,2,3,...)
PTZ model up, down, left, right			Arrow keys
Save current layout as a customized layout	Ctrl (Win) / Command (MacOS)		S
Undo layout modification	Ctrl (Win) / Command (MacOS)		Z
Redo layout modification	Ctrl (Win) / Command (MacOS)		Y
Timeline			
Sync Playback mode	Ctrl (Win) / Command (MacOS)	Shift	S
Pause (Play/Rewind)			Space
Play	Ctrl (Win) / Command (MacOS)		Arrow right
Rewind	Ctrl (Win) / Command (MacOS)		Arrow left
Speed up	Ctrl (Win) / Command (MacOS)		Up
Speed down	Ctrl (Win) / Command (MacOS)		Down
Next frame		Shift	Arrow right
Previous frame		Shift	Arrow left
Reset speed to 1x	Ctrl (Win) / Command (MacOS)		1 (one)



Smart search II			
- Configuration page			
Delete detection range			Esc
Bookmark search			
Select more bookmarks	Ctrl (Win) / Command (MacOS)		Click
Select more bookmarks		Shift	Click
Back to bookmark page			Esc
Next bookmark			Arrow right
Previous bookmark			Arrow left
Thumbnail search			
Select thumbnail			Arrow keys
Play a selected thumbnail			Enter
Back to Thumbnail page			Esc
Next Thumbnail			Arrow right
Previous Thumbnail			Arrow left
Emap Setup			
- Google map			
Remove selected GPS			Del
DI/DO Device Settings			
Remove selected external I/O device			Del
SMTP Settings			
Remove selected SMTP server			Del
Camera Management			
Rename selected camera			F2
Rename selected folder			F2
Remove selected camera from system			Del
Stations Management			
Rename selected station			F2
Remove selected station from system			Del
Users Settings			
Remove selected user			Del
Schedule Settings			
Remove scheduled time frame			Del

Data Magnet			
Move selected row			Up / Down
Show detail of selected row			Enter
View management			
Rename selected view			F2
Delete selected view			Del
Alarm management			
Delete selected alarm			Del
Alarm list window			
Mute the current alarm	Ctrl (Win) / Command (MacOS)		m
Designate the selected alarms as false alarms	Ctrl (Win) / Command (MacOS)		f
Select all alarms	Ctrl (Win) / Command (MacOS)		a
Select one or multiple alarms	Ctrl (Win) / Command (MacOS)		left mouse button
Select multiple alarms		Shift	left mouse button
Select different alarms			Up/Down/Left/Right



View Cell Elements

On a view cell, the control elements are different with different types of network cameras. 3 major types are listed below with applicable screen elements:

1. Fixed cameras:  Snapshot - Thumbnail search - Smart search - Replay.

2. Fisheye cameras:  Fisheye display mode - Snapshot - Thumbnail search - Smart search - Replay.

The Auto pan function applies only to the Regional views. Select a regional view, and click the Auto pan button. The Regional view will pan from side to side to cover more viewable regions. If a fisheye is mounted on wall, a regional view with auto pan can cover a panoramic view region.

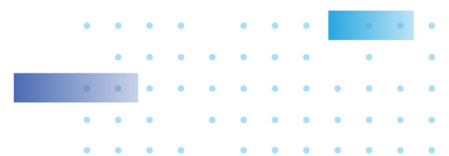
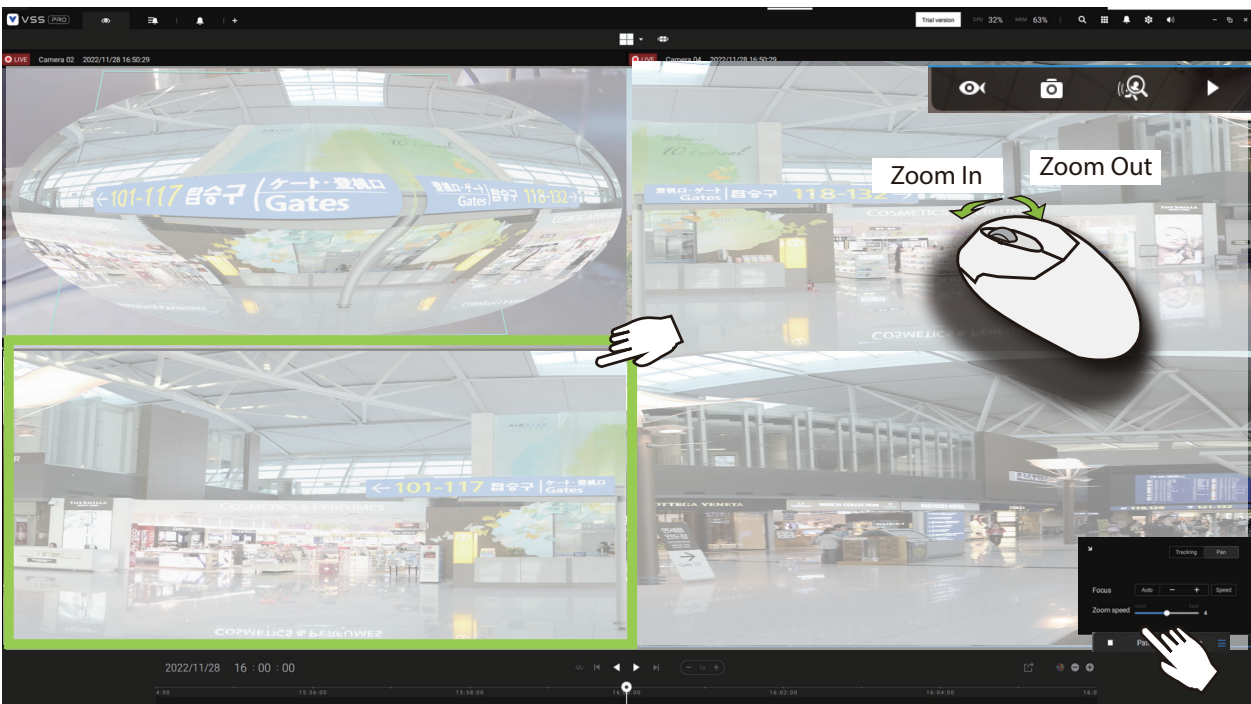

3. PTZ cameras:  PTZ - Snapshot - Thumbnail search
- Smart search - Replay.

To exert PTZ control, first click on this button  to enable PTZ control.

When PTZ control is enabled, the following controls are available on screen:

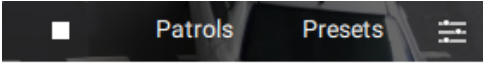

Click Patrols or Presets if these have been configured on the PTZ camera. You will need to open a web console to the camera to configure preset positions.

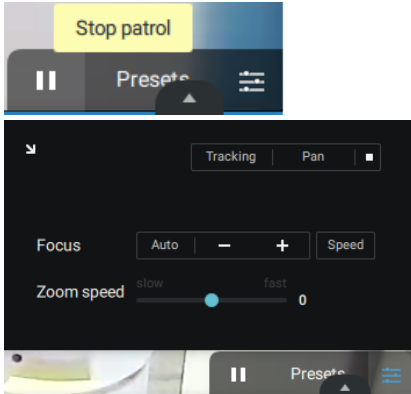

The PTZ settings tab allows you to enable PTZ Tracking and the Pan functions. You can also adjust the Zoom and Focus speed, or manually adjust the focus. Please refer to the camera User Manual for more information about these functions.

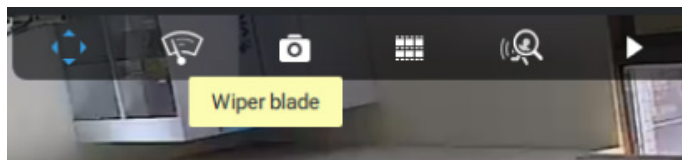
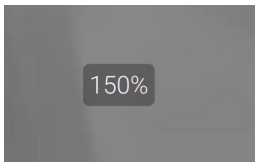

For speed dome cameras that come with a wiper blade, the wiper blade control button will be available on the tool bar.

You can use the mouse wheel to zoom in or zoom out on the screen. The zoom ratio is shown on screen for half a second.



When PTZ is enabled, the zoom buttons and a home button are displayed on the right-hand side of the view cell.

For more information about Snapshot, Thumbnail search, and the Replay functions, please refer to their specific help pages.



3. Motorized lens cameras:  Enable Optical - Snapshot - Thumbnail search - Smart search - Replay.

For cameras that come with motorized zoom lens, click on the Enable Optical button. You can zoom in or zoom out on the scene.

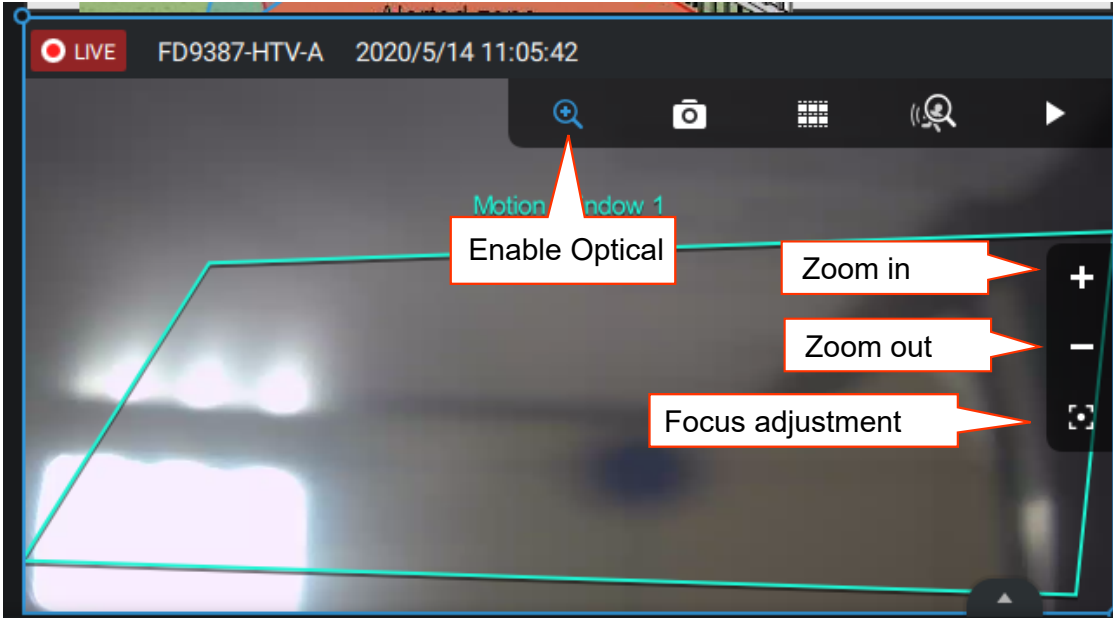

Click on the Focus adjustment button to bring out the focus panel. If you find the image is out of focus, you can use the +, -, or Auto buttons to regain the best image focus.

You can use the Auto scan function to let the camera automatically find the best focus. The process may take up to 20 seconds.

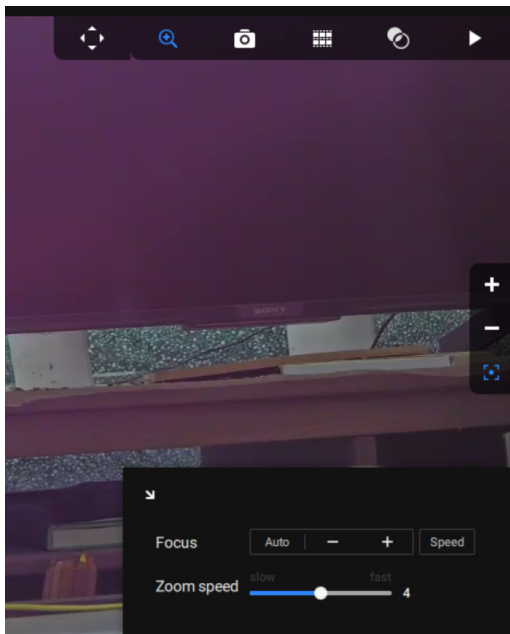

Audio

For a view cell housing a camera with an audio input, you can tune its volume using the slide bar on the tab panel.

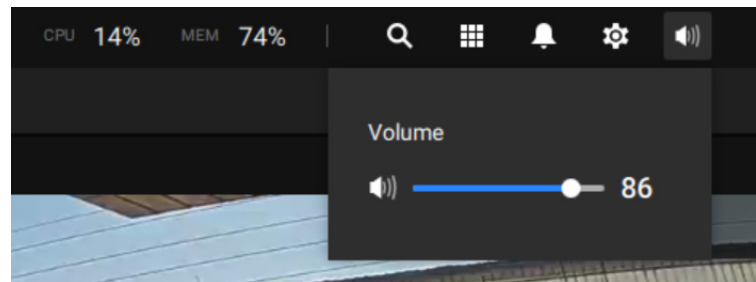

Server and Client Components

VSS Server provides a centralized management site for video recording. Users can login and modify the server's configuration, edit the server's recording storage, configure schedules and many other functions. You can browse the recorded video database and video clips related to specific events on the server.

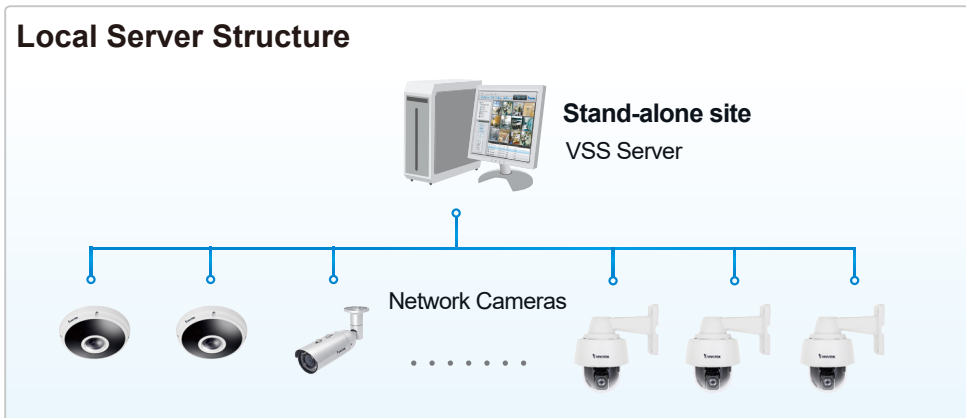

For users who manage large-scale surveillance deployments, please plan the hierarchical structure first. Then you can start to add cameras to each station and connect these sub-stations to the root station. The whole hierarchical management system is thus constructed. VIVOTEK's NVR stations can also be included as sub-stations. The Logical Tree view becomes the default.



Multiple Server Applications

A host with the VSS installed is recognized as a stand-alone station. All the functions can be simultaneously performed on one single station.

Remote Server Structure

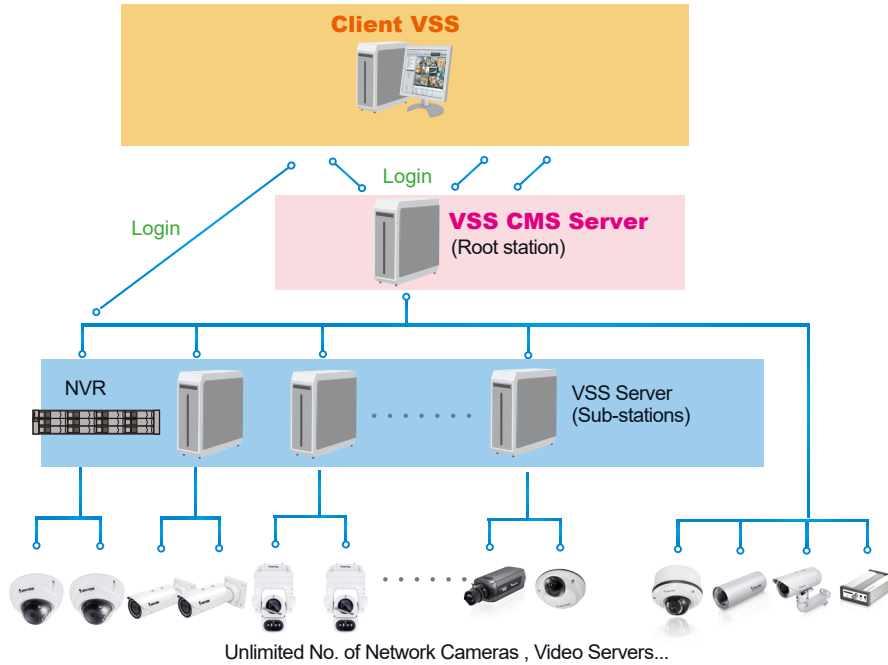

Please refer to the Stations page for how to enlist VSS sub-stations.





Chapter 2: Starting Up

Double-click the VSS icon  on the desktop to start the VSS main page.

When started the first time, the server automatically polls the local network for reachable network cameras. For cameras that come with pre-configured User Name and Passwords, the server prompts for entering credentials for the access to cameras. Check out the cameras' MAC addresses to identify the cameras.

The cameras found within the network will be listed. If the need should arise, you can use the Search panel on top to locate specific cameras using their IP, MAC, Port, Model name, or brand name (ONVIF/VIVOTEK).

Use the  Add device button to manually add a camera with its known IP or domain name.

Use the  Import Device List button to recruit cameras in a previously-saved device list (CSV files).

Use the Authorize button if the camera found in the Search panel needs credentials.

When search is done, delete the alpha-numeric characters in the search field to return to the device list.

Use the Refresh  button to search the local network again.

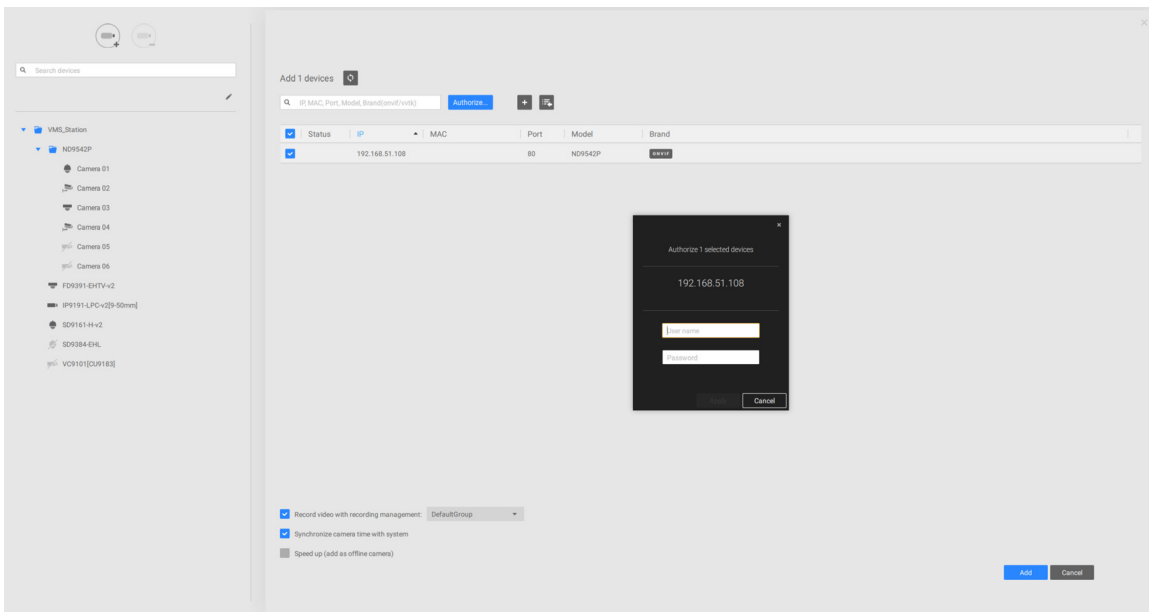

2-1. Selecting Devices

Use the checkboxes in front of the listed devices to determine which devices will be recruited to your configuration. By default, all cameras are selected. When the selection is done, click on the Next button at the lower right screen.

If any of the selected devices requires credentials, the authorization window will prompt.

NOTE:

For cameras that come without a password protection, you should open the Shepherd utility to locate and open a web console, and configure a password for protecting the access to the camera. If a brand new camera (with no password) is selected for your VSS configuration, it will join your configuration without the password protection.

Language

FD9181-HT

Configure password

At least 8 characters with no space, one alphabet character(uppercase or lowercase), and one numeric character

User name : root

User password : Medium

Confirm user password :

Enable https connection to secure the configuration for password

*The new password will be applied to all connections

Save Cancel

2-2. Recording Options

Click Settings > Recording > Recording options. The Recording options window will prompt.

You can configure recording schedules or select the storage options, including the configuration of an external NAS storage.

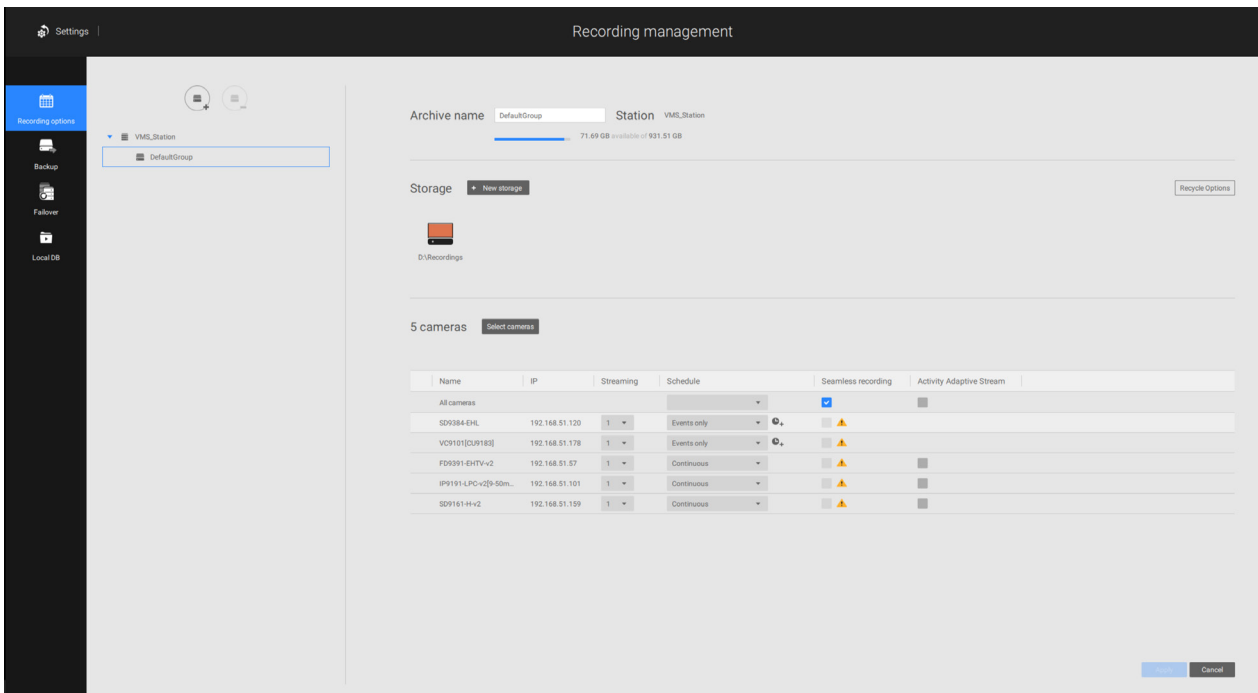

Click on the Schedule column on the Camera list for a recording option: Continuous recordings, Events only, None, or Default Schedule, or New template. You can apply a schedule template for all cameras or configure individual schedules for different cameras. When using the Event-triggered recording, a pre-event and post-event time can be configured. An Edit pane is available by clicking the Edit  button.

You can manually create a recording template using the New template option. When done, each configured template will be listed below.

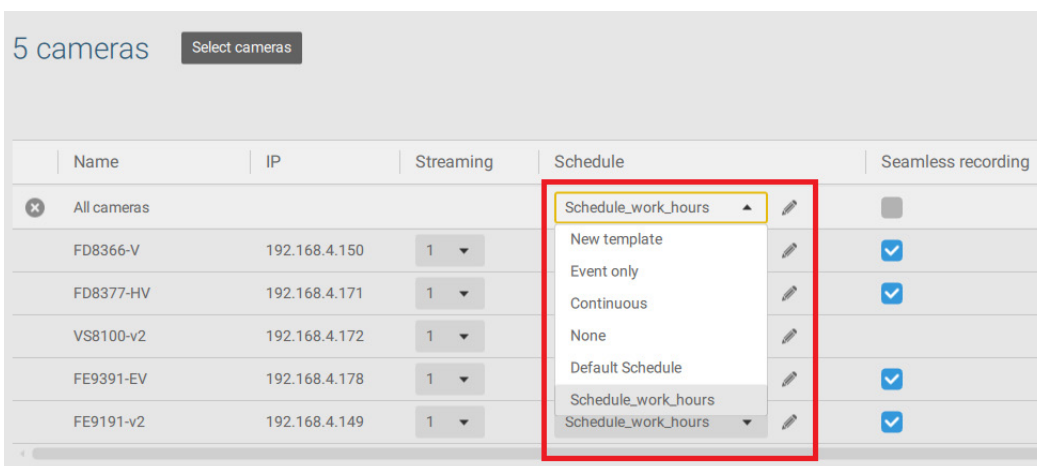

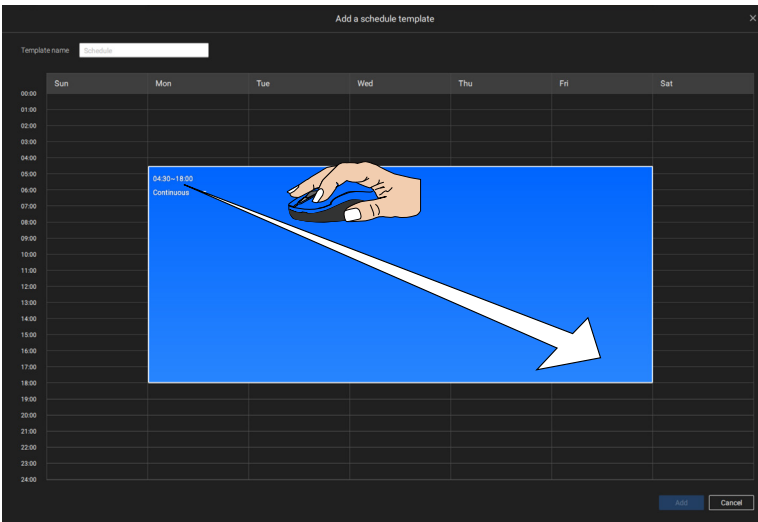



Click and hold down on the time cells, and drag the mouse to include the time span of your preference. The minimum selectable unit is half an hour. You can select separate and multiple time spans on the template.

Enter a name for the template, and click Add to save your template.

The same configuration window apply to both the Schedule template and the customize schedule windows.

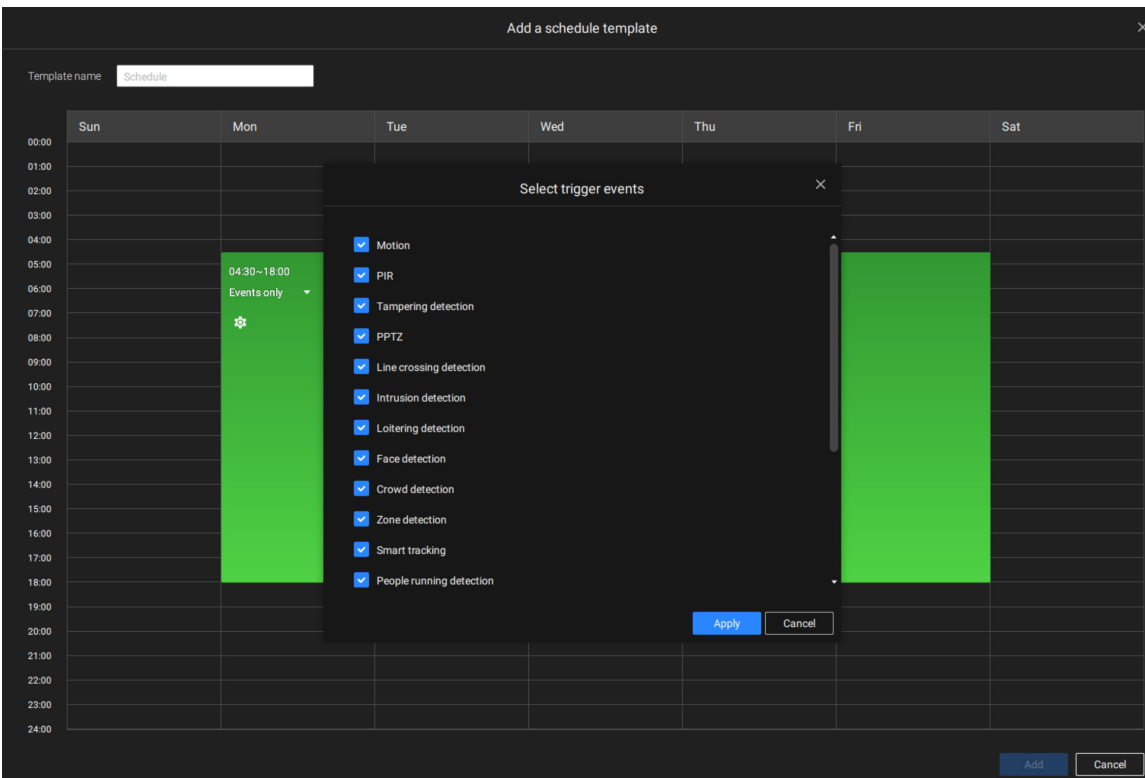
If the Events only option is selected for the new template, you can determine what kinds of events will trigger the recording. Use the pull-down menu to select Events only.



When Events only is selected, click on the  Settings button to proceed.

The applicable event types will be listed. Select the types of event triggers that you prefer. Click Apply to leave this page. By default, all applicable event triggers will be selected.

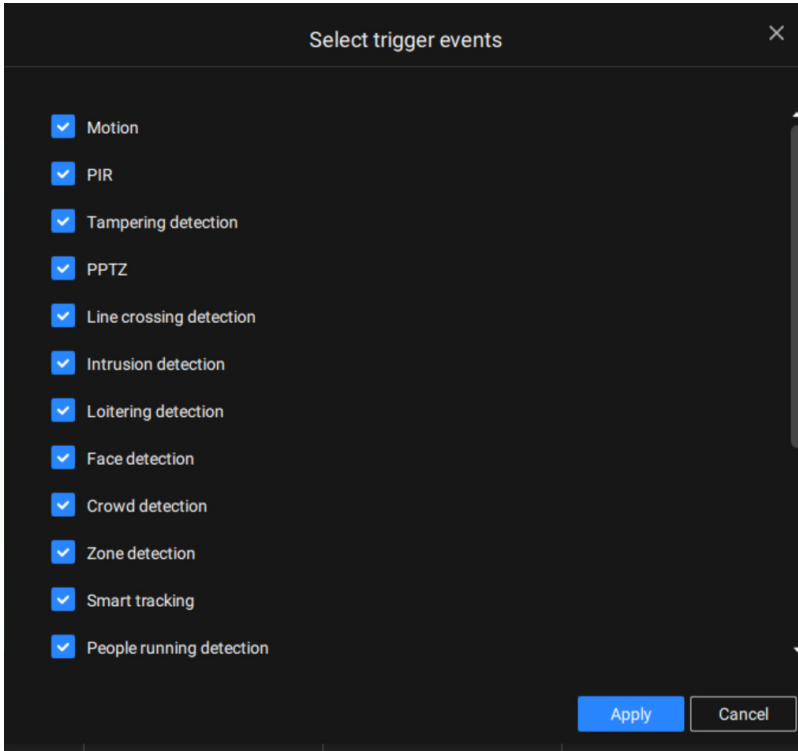

Back on the Recording options page, select the new template as a scheduling option. Use the menu on the top to select a scheduling template for all cameras.

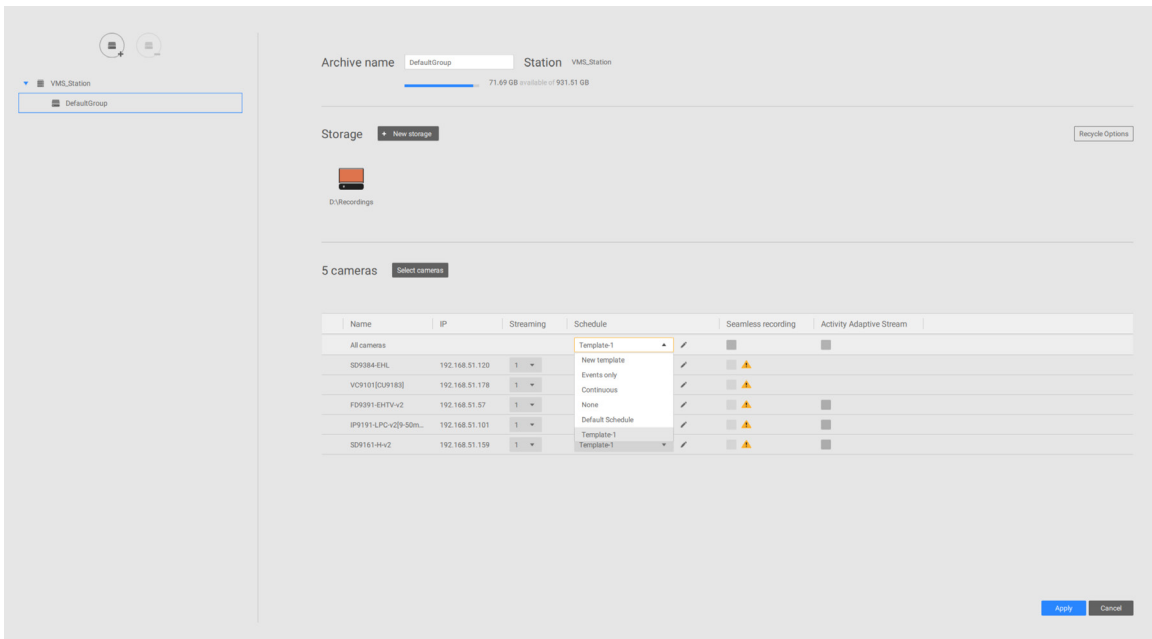

Make sure a Schedule mode is selected when you leave this configuration step.

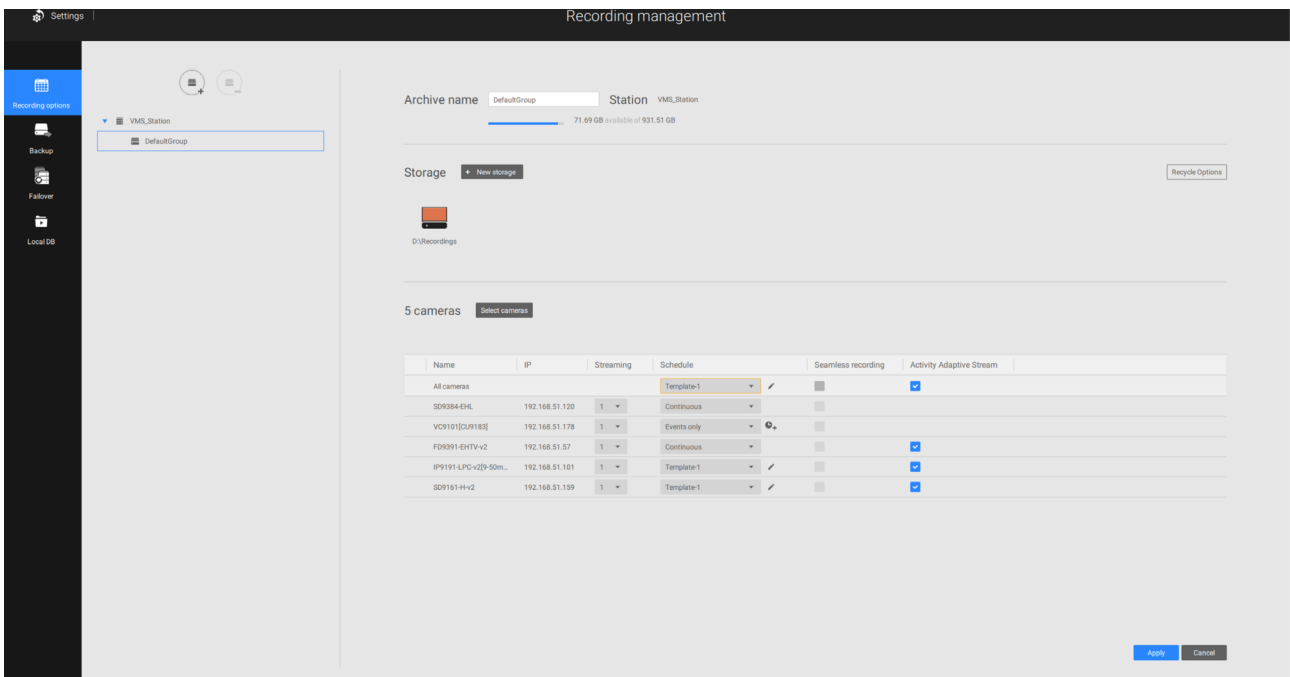

Seamless Recording

Seamless Recording safeguards critical videos in the occurrences of network disconnection. In the event of temporary disconnection, video is stored in individual cameras' SD/SDHC/SDXC card; and once the connection is restored, a VSS server can automatically resume the recording. More remarkable is that, a VSS server can simultaneously retrieve the time-tagged videos that were temporarily stored on SD/SDHC/SDXC cards. For information about the latest firmware/software revisions that support this feature, please contact your sales representatives or technical support.

Seamless Recording

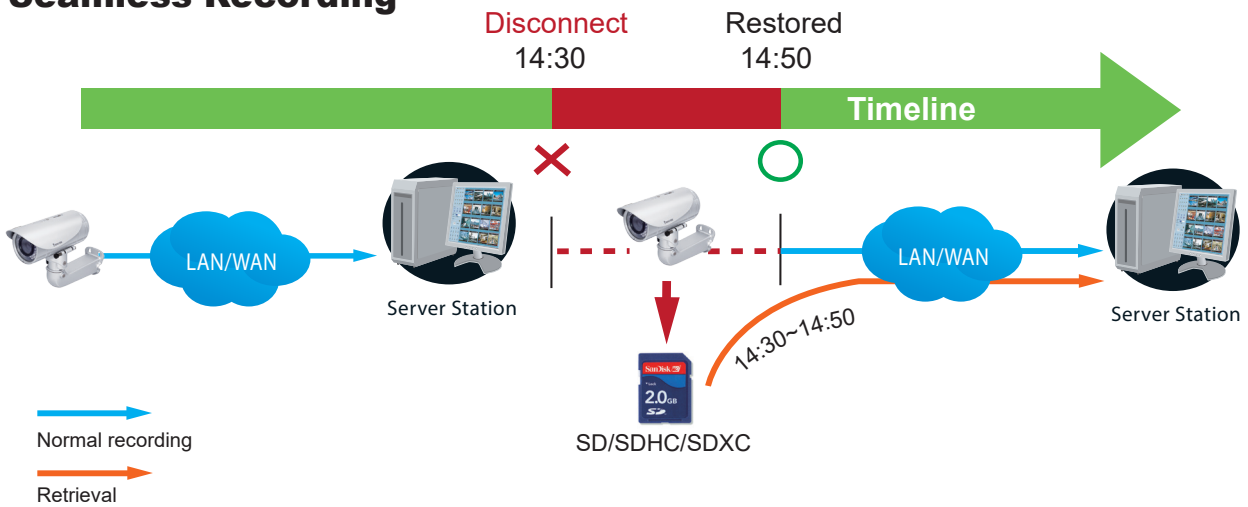

The video data retrieved from SD/SDHC/SDXC card also include event-triggered recordings such as pre- or post-event footages, if events were detected during the network outage.



The Seamless Recording feature is enabled when inserting, updating, or batch inserting cameras in the Camera Management window. The firmware/hardware compatibility of this feature is automatically detected, i.e., this feature is not available when a non-compliant camera is attached. If a compatible camera is attached, a checkbox will be available as shown below.

If a camera comes without an SD card, the SD card presence is detected with a warning message.

To enable Seamless recording, find the associated option in Settings > Recording options, and select the Seamless recording checkboxes. Camera models that support the Seamless recording option will have it listed.

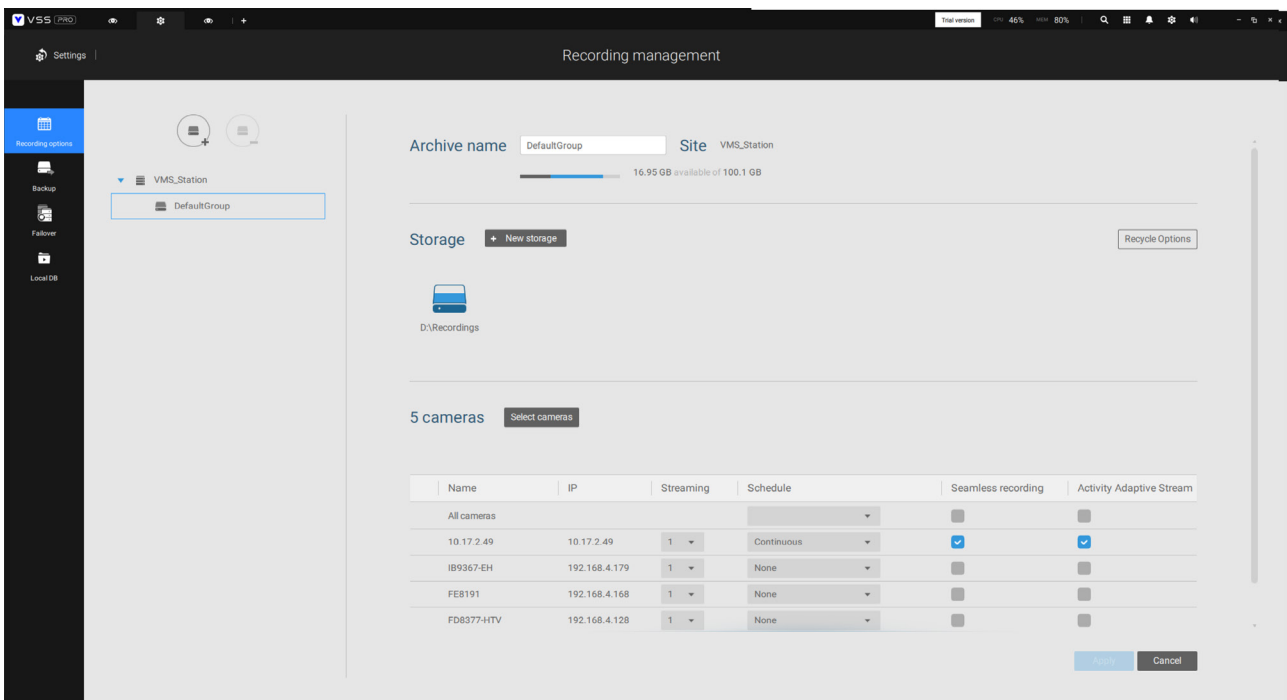

Activity Adaptive Stream

- Activity Adaptive Stream: (Note that this feature may not be available for some older models)

This option will activate the frame rate control according to alarm trigger.

The frame control means that when there is a triggered alarm, the frame rate will raise up to the value you've configured on the Video quality page.

If you enable adaptive recording on a camera, only when an event is triggered on a camera will the server record the full frame rate streaming data; otherwise, it will only request the I frame data during normal monitoring, thus effectively saves bandwidth and storage space.

The alarm trigger includes: motion detection and DI detection.

On individual cameras, you can configure the following:

- Pre-event recording and post-event recording
The Network Camera has a buffer that temporarily holds data for a period of time. Therefore, when an event occurs, the camera can retrieve image frames taken several seconds ago. Enter a number to define the duration of recording before and after a trigger is activated.
- Priority: Select the relative importance of this recording (High, Normal, or Low). Recording with a higher priority setting will be executed first.
- Source: Select a video stream as the recording source.

NOTES:

- * To enable adaptive recording, please make sure you have configured the trigger sources such as Motion Detection, DI input, or Manual trigger.
- * When there is no alarm trigger:
 - JPEG mode: record 1 frame per second.
 - H.264 mode: record the I frame only.
- * When the I frame period is > 1 second on the Video settings page, firmware will force decrease the I frame period to 1 second when the Activity Adaptive Recording feature is enabled.

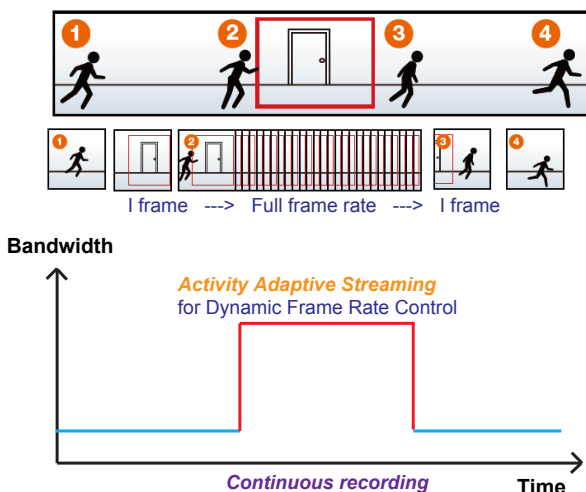

2-3. Storage

By default, VSS will check if the D: drive is available. If no other disk drives can be specified, the system drive C: will still be defined as a storage option. Other disk drives in the system, and the default storage volume (configured in the initial setup) will be listed.

You can add a NAS storage's share volume as the additional storage option. Enter the necessary information for access to a network share. Enter and select a NAS path. The share will then be available for video recording.

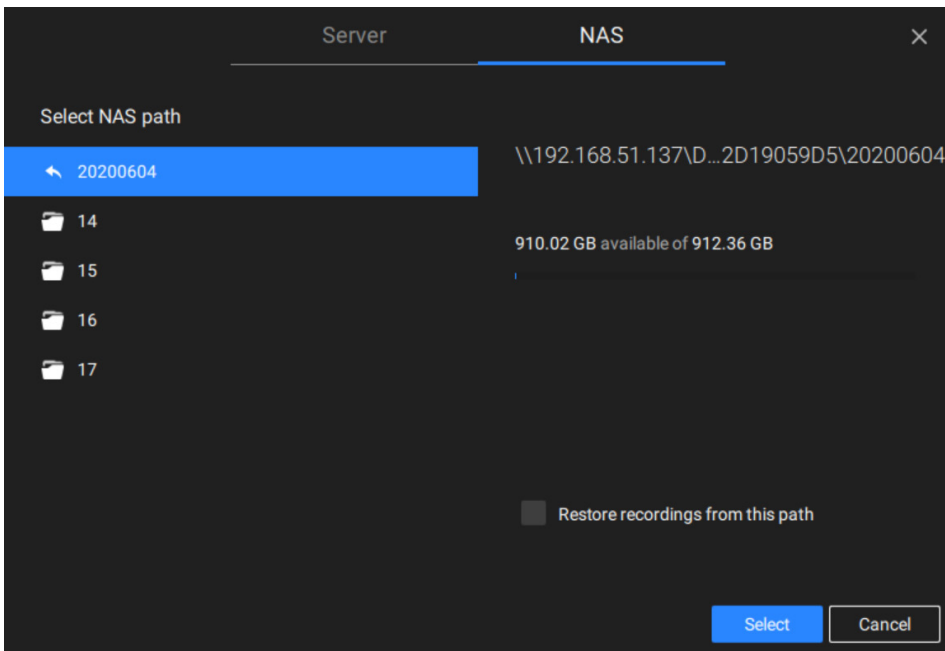

Select storage volumes each by a single click.

Click Ready to use to continue. The server will take several minutes synchronizing configuration between server and cameras, and the time settings between them.



Adding NAS (Network Attached Storage) as a Storage Option

You can also record videos to a networked storage.

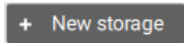
1. Click the Add archive  button.
2. Enter a name for the configuration.
3. Click the Add storage  button.

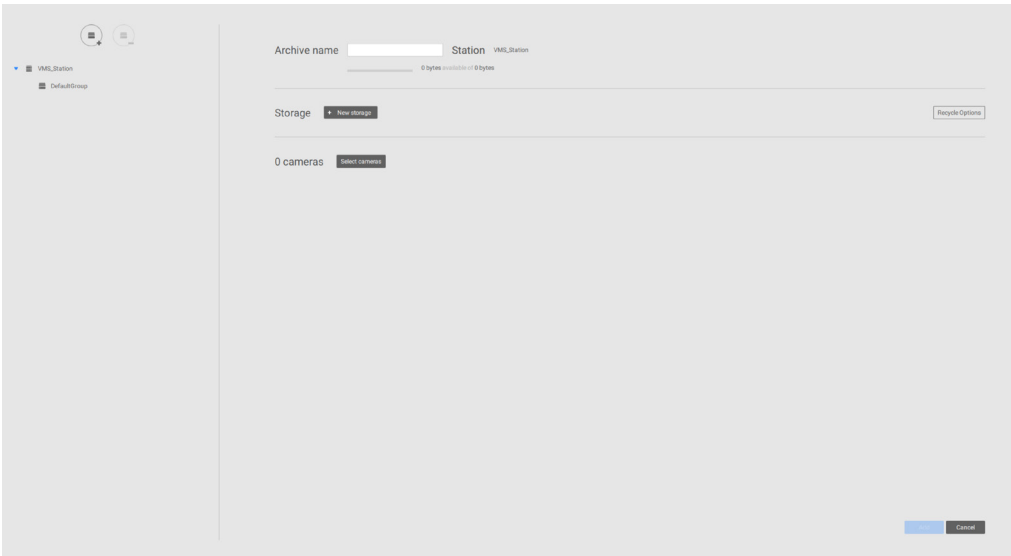

4. Click the + New NAS button.

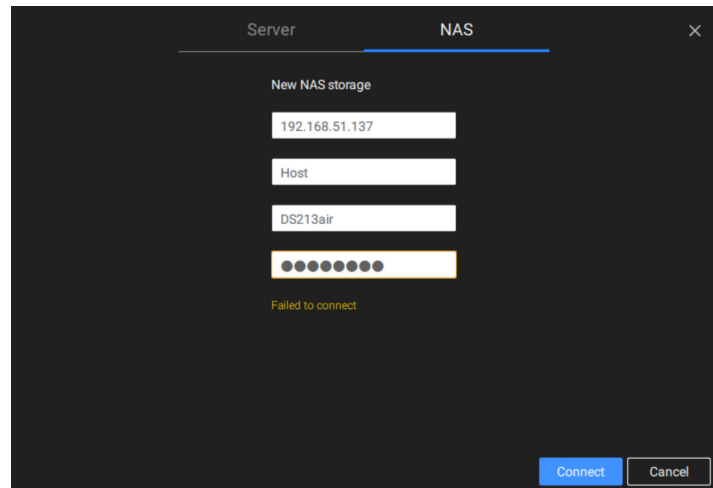
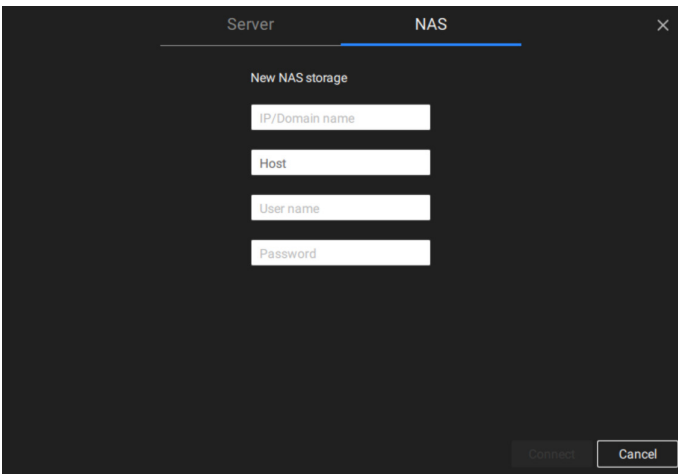

5. Enter the NAS storage's address and the credentials for access to the networked storage. When done, click the Connect button.
6. The NAS storage should appear on screen. The connection may take several seconds. Single-click on the NAS storage to select its network shares.

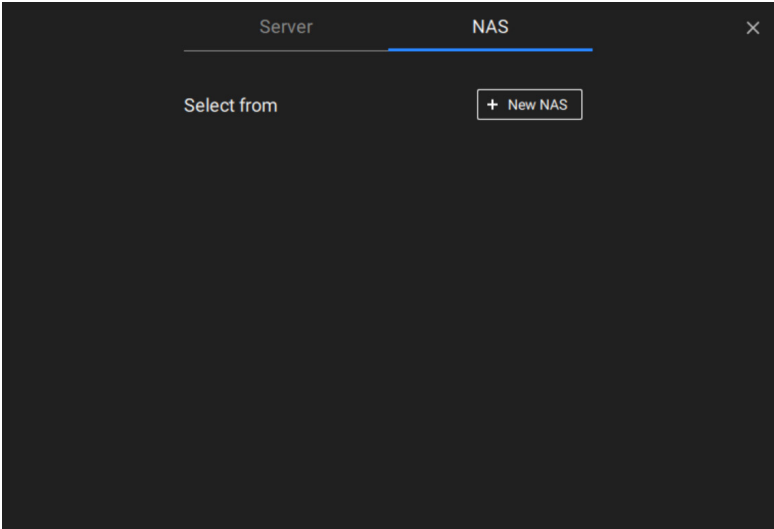

7. The NAS storage's network shares should be listed. Single-click to select a network share.

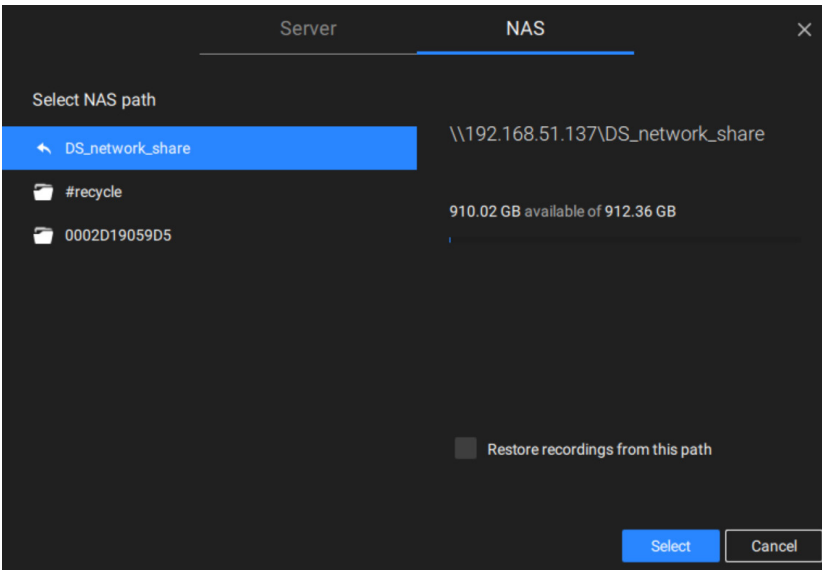

8. Click Select when done. Note that you can repeat the previous process to select multiple network shares from a single NAS storage.

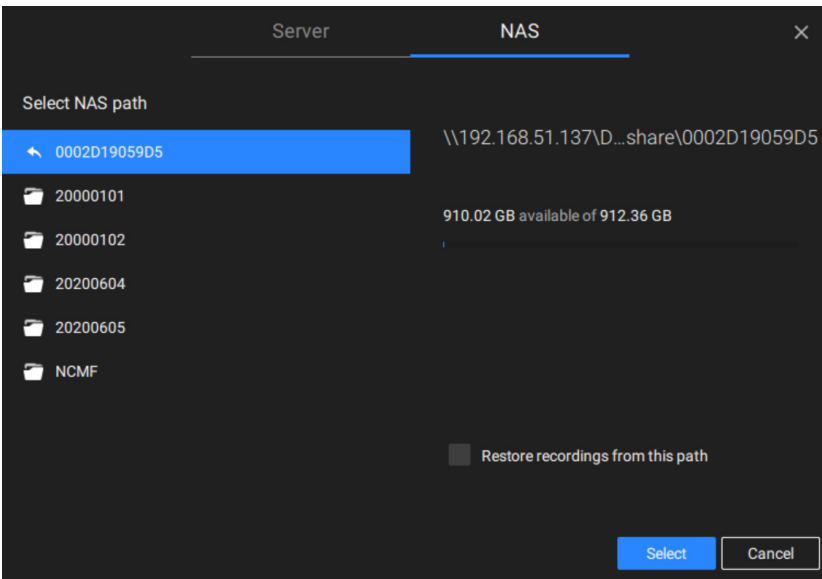

2-4. Starting Up - Main Page

You will be defaulted to the Live view once the main page displays. Another tab window is the Search panel where you can search recorded events and recorded videos.

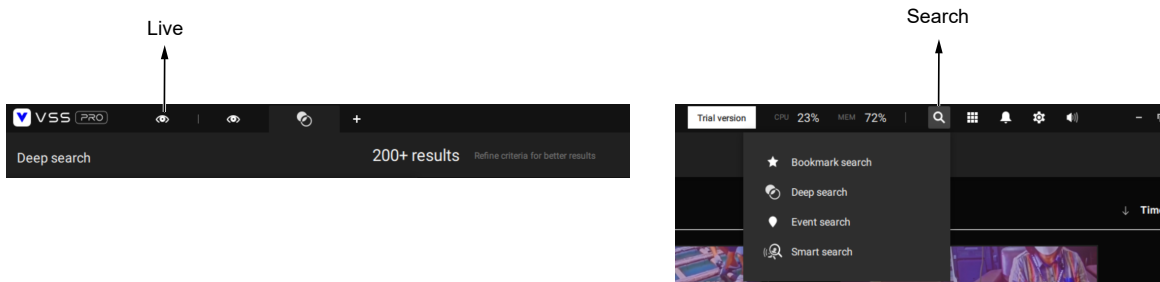

On the initial start up, the server should fill the live camera feed to the available 2x2 view cells (4). You should then select a preferred layout, e.g., 3x3 or others, using the Layout pull-down menu.

The available layouts are categorized into 4 types: Equal, Panorama, Focus, and Vertical.

Equal: 1x1, 2x2, 3x3, 4x4, 5x5, 6x6, 7x7, 8x8.

Panorama: 1P(Panoramic)+6, 2P, 2P+3, 3P. (applies to fisheye cameras)

Focus: 1+12, 1+16, 1+3, 1+5, 1+7, 1+9, 2+8.

Vertical: 1V+6, 2V+2, 2V+3, 3V, 3V+4, 4V, 4V+4, 5V. (applies to corridor view)

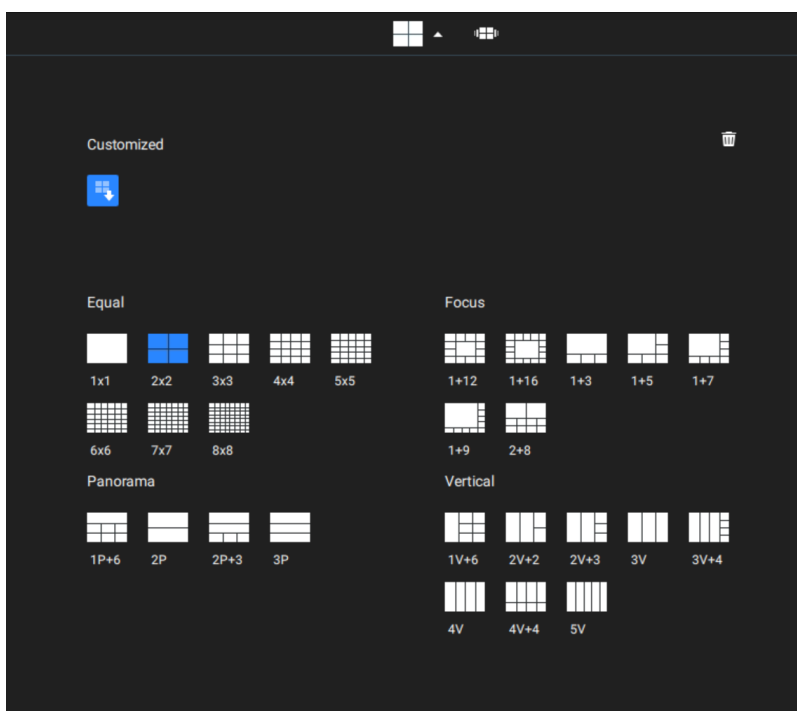

To design and customize a layout, please refer to the [Customizable Layout](#) page.

You can then fill in the view cells by dragging and dropping cameras into the view cells. While dragging, a name tag displays. All cameras should be listed under the VMS_Station Device Group.

You can swap two view cells by dragging one on top of another.

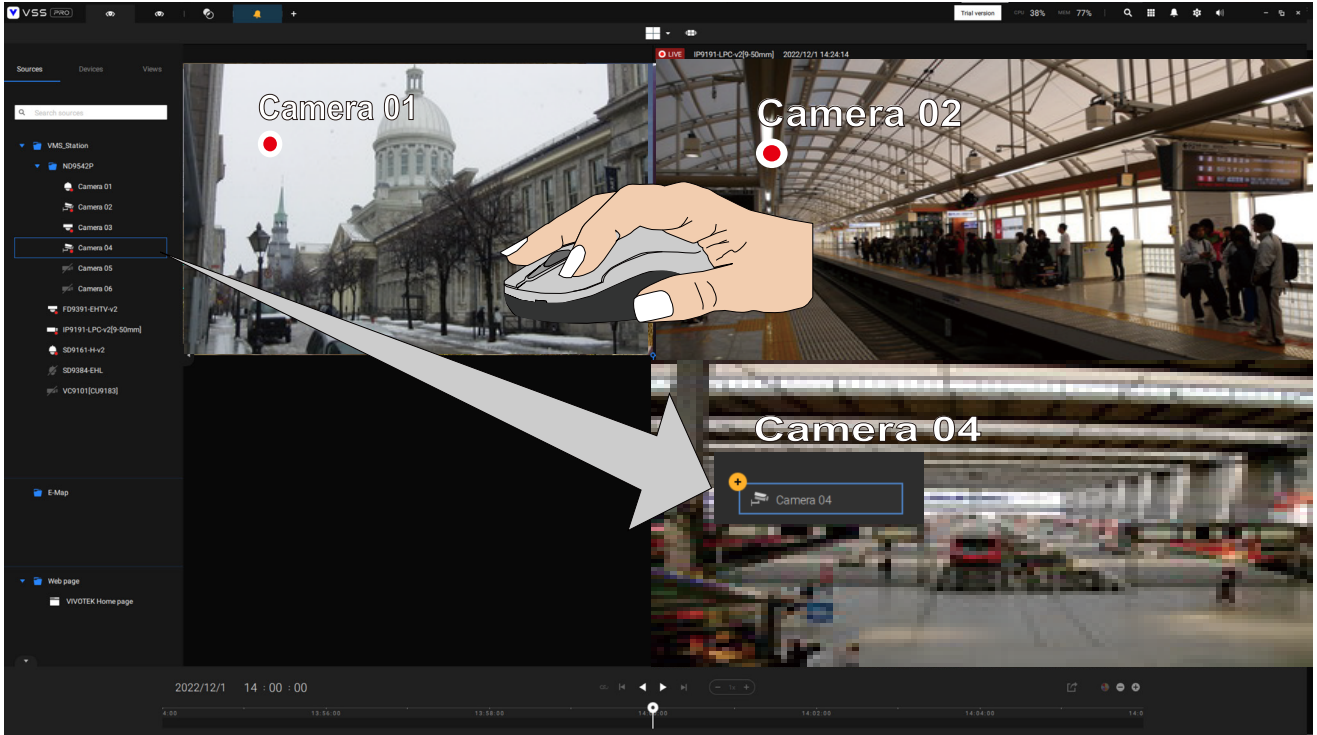

You can also configure a view cell to display a web page by a right-click on the Web page option on the left device pane. Enter a name and the URL address.

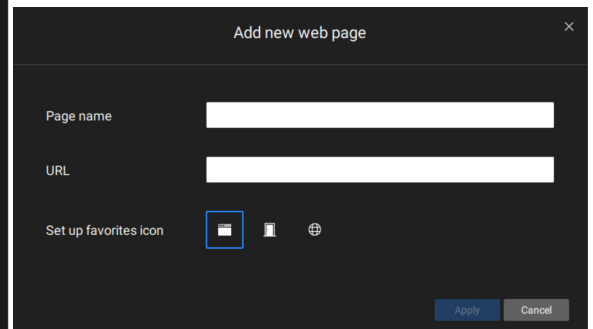
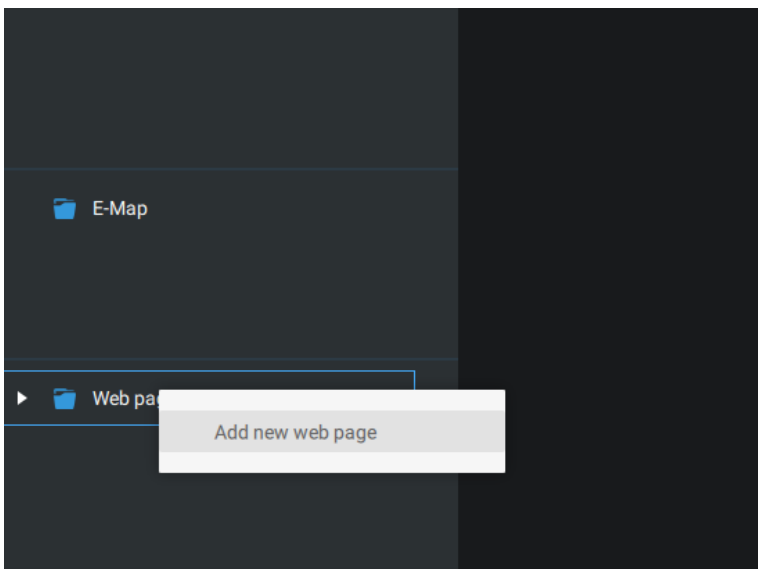

When configuring a web page to be displayed in view cell, You can select a favorite icon.

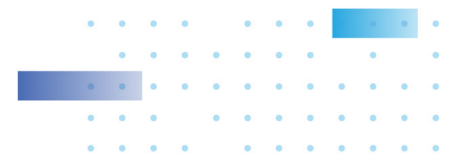

You can also fill in an Emap by dragging and dropping a pre-configured Emap into a specific view cell. Click on the E-Map tab to select a pre-configured E-Map. Note that an E-Map should be placed into a larger view cell.

Depending on the resolution of your monitor, a view cell can be too small for an E-Map. For example, for an HD monitor (1920x1080), a single view cell from a 3x3 layout will have a resolution of 640x360. View cells larger than 330 (width) x 300 (height) pixels can contain an E-Map.

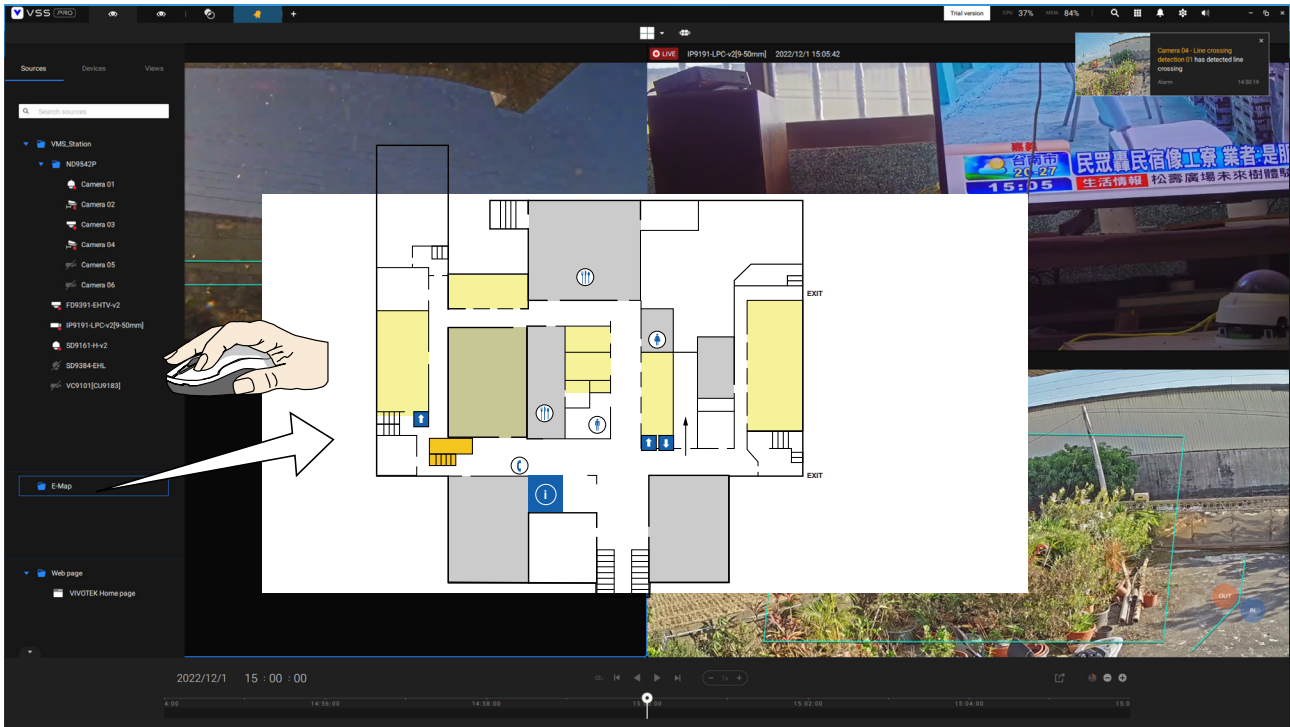



2-5. Customizable Layout

The standard layouts can be manually configured to form layouts of your choice. Depending on the complexity of your design, you should start with a multi-cell layout.

Click and drag the corner mark on a view cell. Drag across the screen and release the mouse button to enlarge the view cell. Choose a standard layout of many view cells, e.g., 7x7 or 8x8, if you want to design a complex customized layout. You can create a special layout, e.g., an especially wide view cell for a multi-sensor camera, such as the panoramic MS-8392.

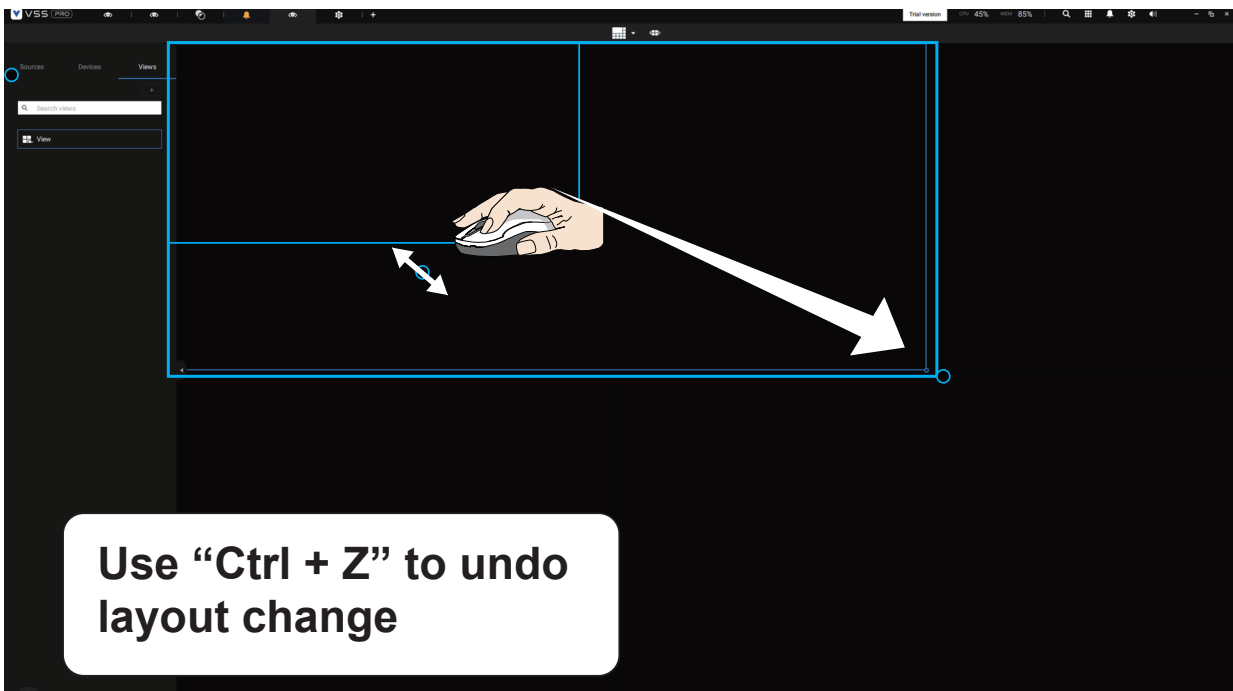
To abandon a customized layout, simply select a new layout from the layout window. You can also use the **Ctrl + Z** keys to undo your changes on the layout.



To preserve your customized layout, click to open the layout window. Click on the Add current layout  button. You may then change the name of your layout by a double-click on its name.

To remove a configured layout, drag it to the garbage can icon on the upper right.

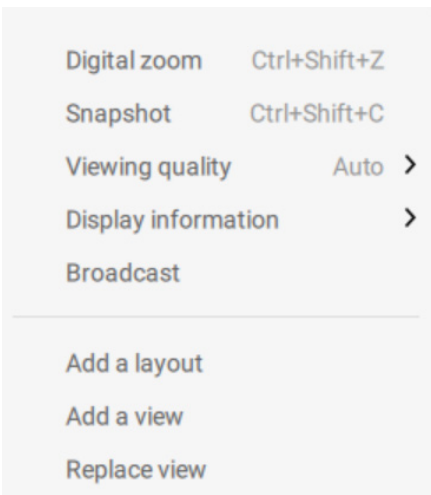
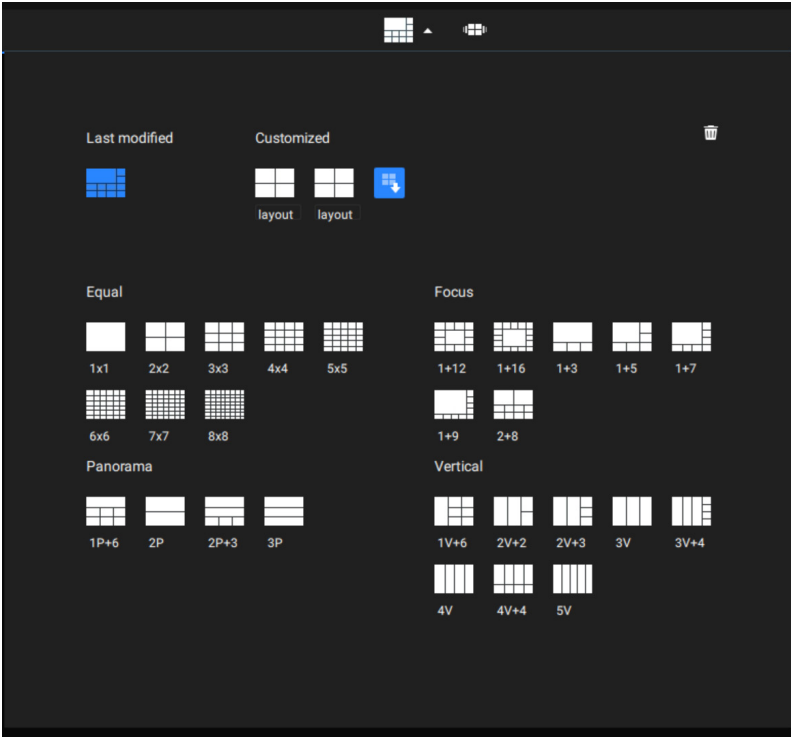

You can also right-click on the screen to display the Add layout option.

You can then click Device Group, and start filling your customized layout with camera views. When done, click Add a view.

Also remember to save the current layout as a view, and save your configuration in Settings > Preferences.

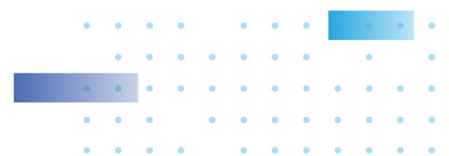

2-6. Saving a View

When done with arranging view cells, click the View tag.

Save your current layout and view cell arrangement as a new view.

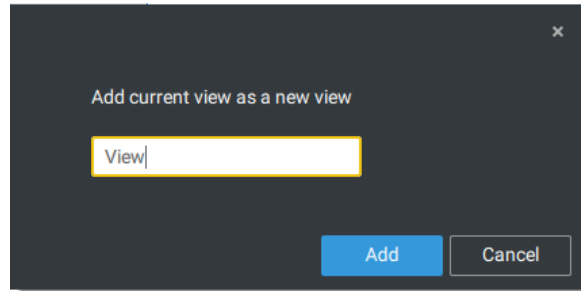
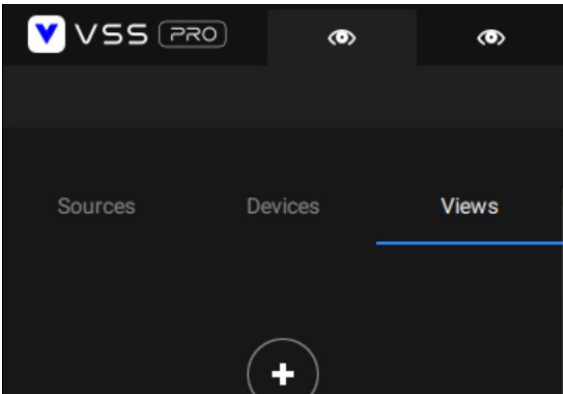

2-7. Add More Live Views

With many cameras in your deployments, you can click the New Tab "+" button to add more Live views.

An empty live view will display, and you should repeat the above process to select a layout, and fill in the view cells. When done, save the view.

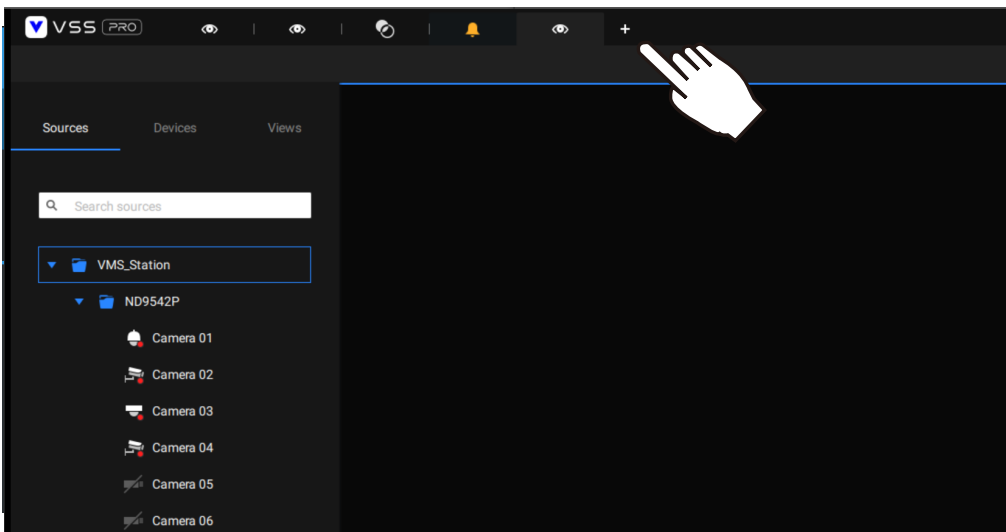

Right-click on the screen to display the right-click menu. Select Add a view.

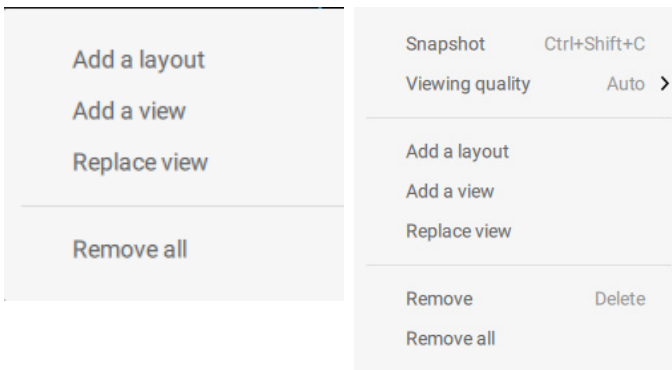

Enter a name for the new view and click Add to proceed. The new view will be listed in the View panel.

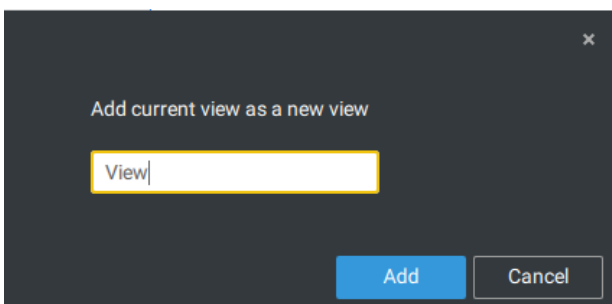

If you have multiple monitors attached to your server station, you can drag a live tab to a different screen. In this way, you can display live views simultaneously on multiple screens.

Live views can be placed on multiple monitors. Please note that the number of monitors to display live views is determined by the capability of your system.

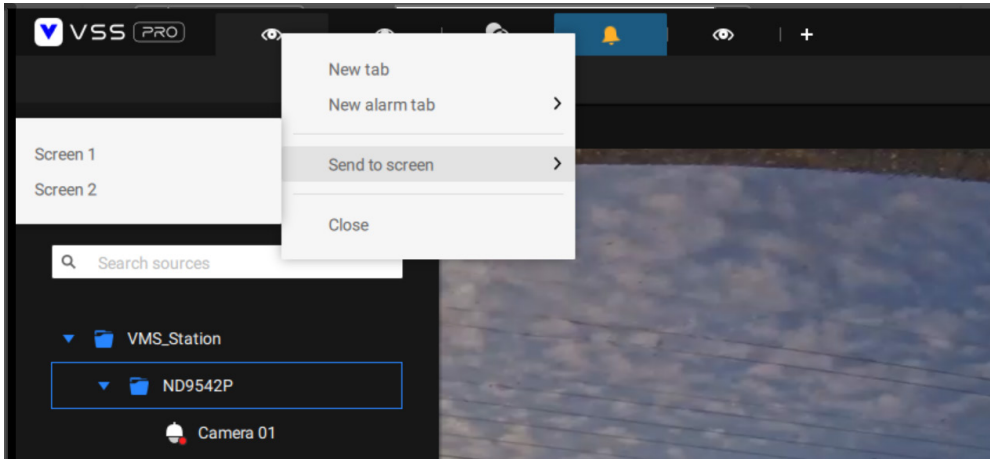

2-8. Tour

A tour can be configured to consecutively display multiple views. A tour allows users to quickly glimpse through many view cells in a timed pattern. As a tour can contain multiple views, you should design and configure camera views before configuring a tour.

To configure a tour,

1. Click on the Add a camera tour  button.
2. Click the Add button.

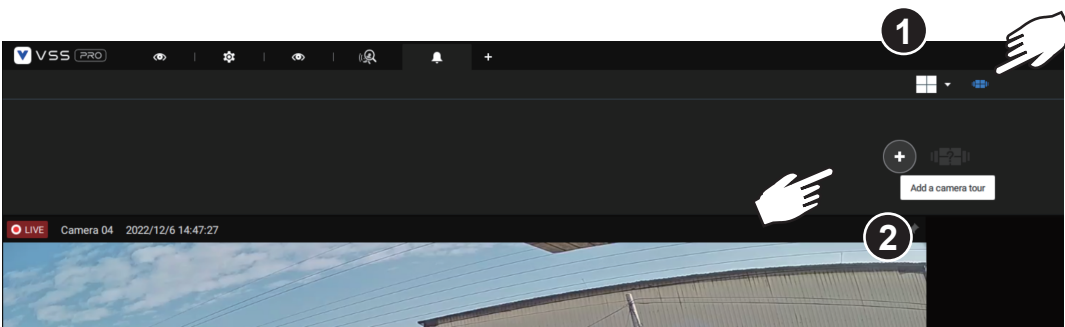

3. Enter a name for the tour.
4. Single-click to select a view. Select multiple views each by a single click.
5. Click the Add Tour button.

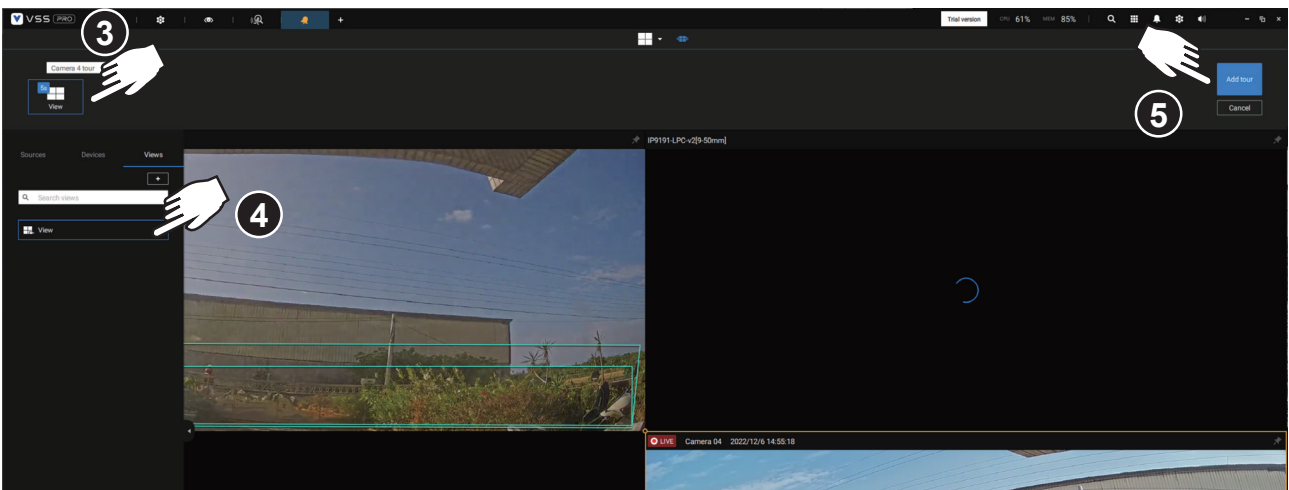

The default for the duration of the display of each view is 5 seconds. You can right-click on each view to display the Duration of each view. You can apply the same duration of all views, or allow each view to display on screen for a different span of time.

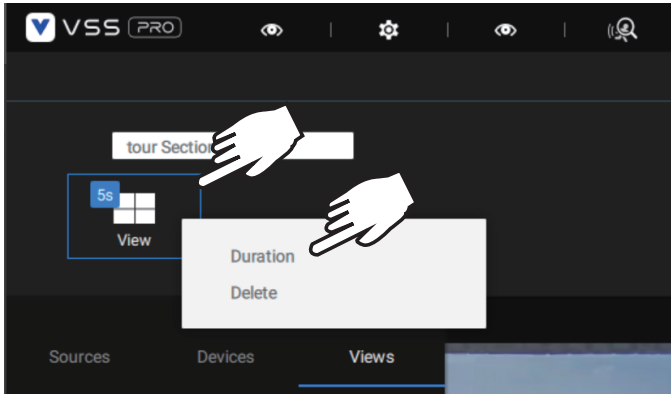

You can enable the Audio tour option which plays the audio inputs from each view cell for a specific period of time.

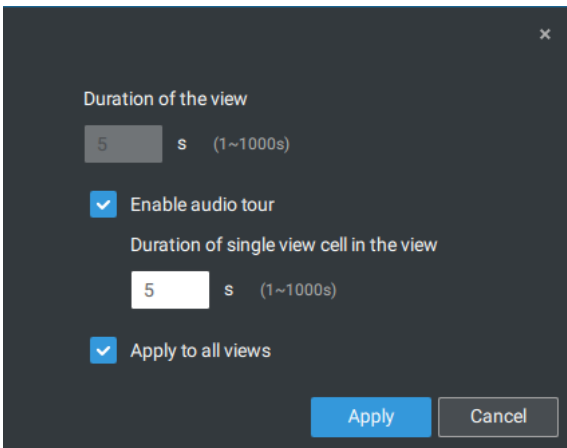

Mouse over a configured tour, and then click to start a tour.

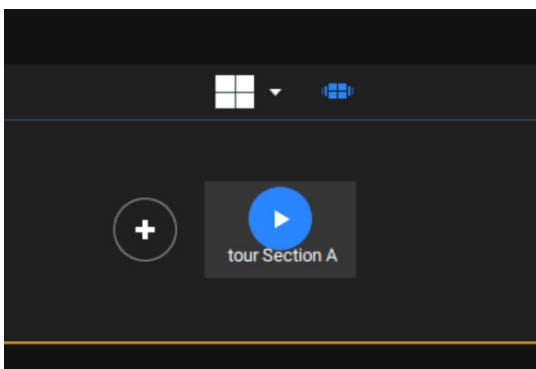

When playing a tour, and you want to stop the tour, you can left-click or right-click on the screen. Click the Tour icon  again to return to the singular live view.



2-9. Save Your Preferences

Go to Settings  > System > Preferences to save your current layout and display configurations.

Select the options in the startup choices menu to decide what to display whenever your VSS client starts. You can display Live view, Tour, Dashboard, E-Map, or Alarm tab simultaneously on multiple screens.

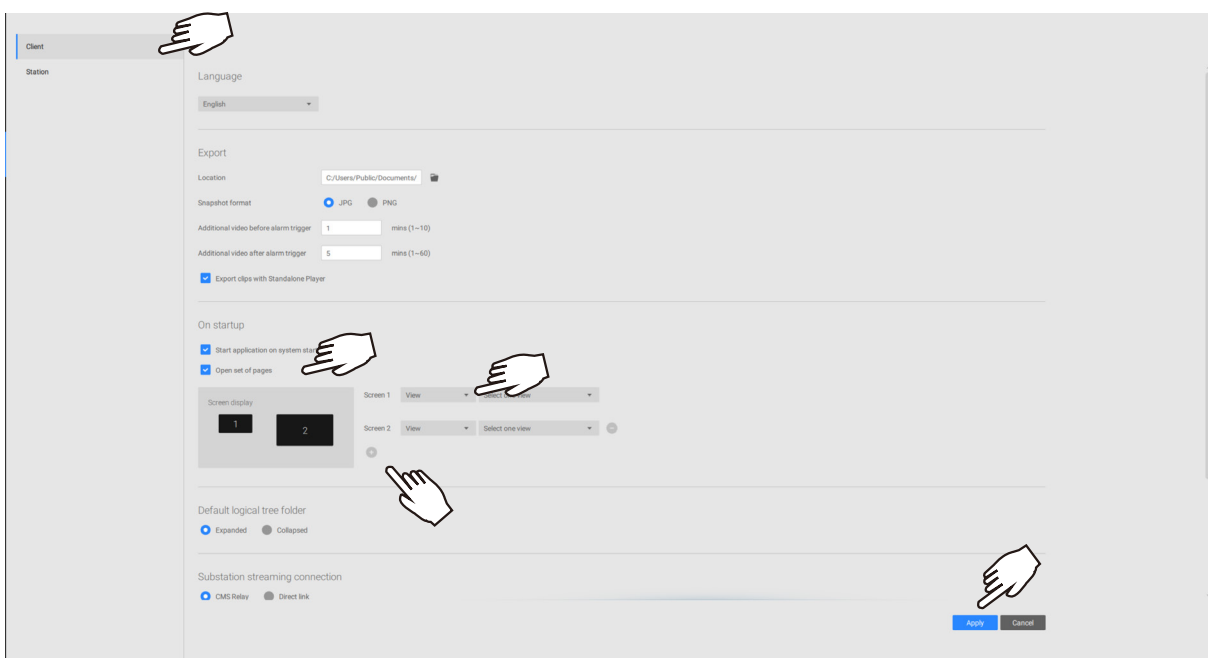
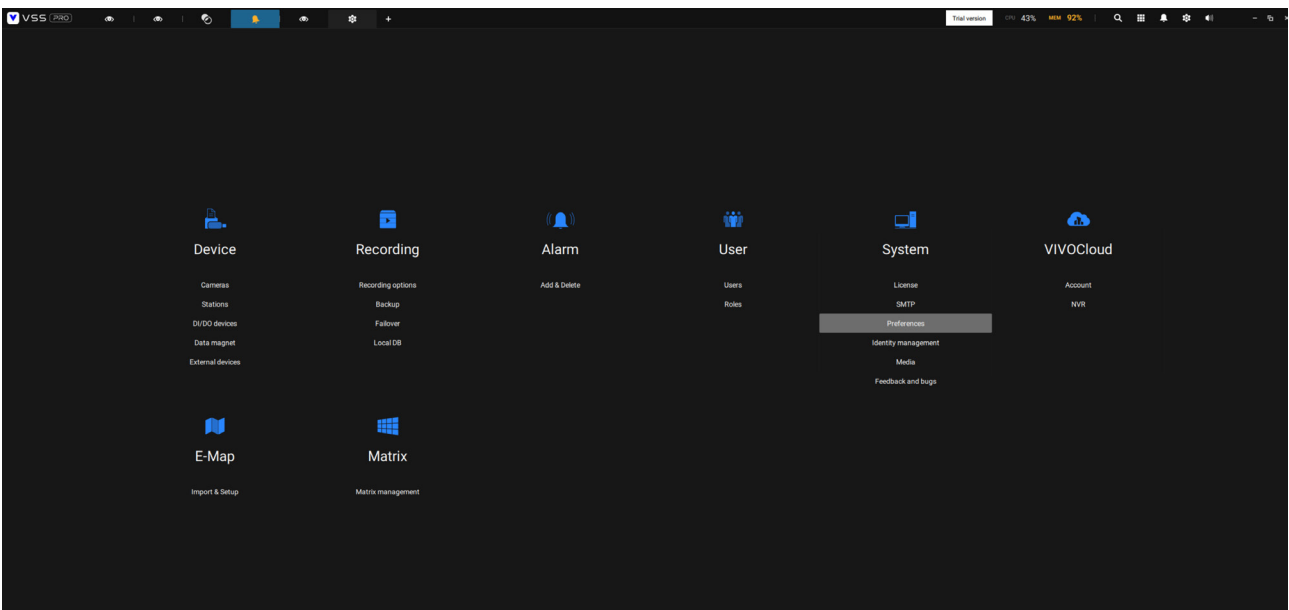

2-10. Playback

To start the playback function, select a camera's view cell (whether in full view or ordinary cell size), then click the playback initiative button (⏮ or ▶). The button can be found on the upper right of the view cell or at the lower right corner of the view cell in the full view.

Default Time: When started, system normally rolls back to the start of the hour, e.g., your current time is 10:30:00, and the default playback position on the timeline is 10:00:00.

Playback control can be found in 3 places:

1. Float Panel: When Playback is started, swipe your mouse to the upper-right of the view cell to display the Playback float panel.

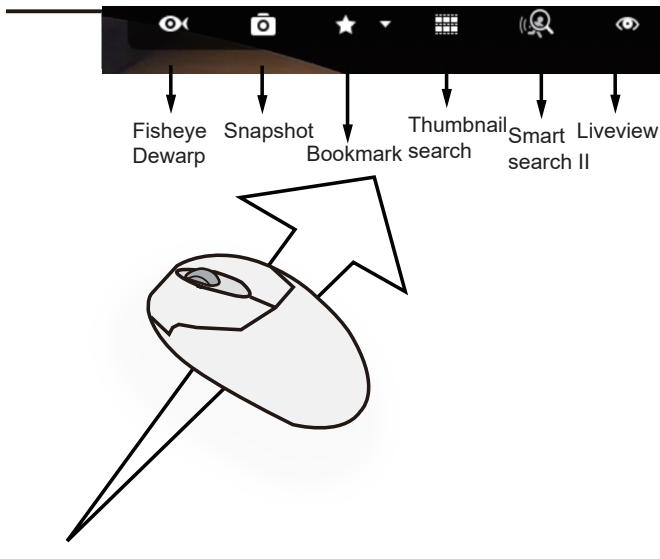

Fisheye Dewarp: For a fisheye camera, you can select different dewarped views during a playback. Click to select an option.

Snapshot: Click to take a snapshot. A small floating window will stay for 2 seconds. You can click the folder icon to access the snapshot files.

Note that a dewarped, regional view allows producing a snapshot of the regional view.

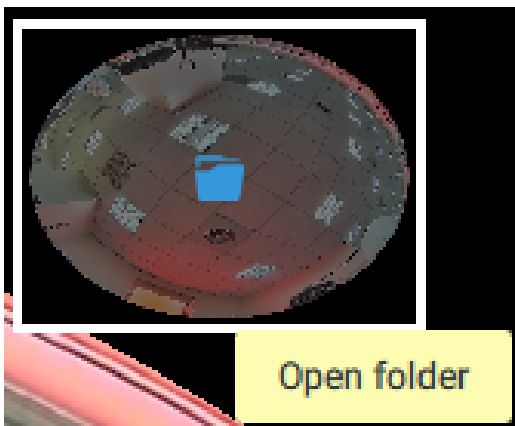

Bookmark: If you find anything of your interest when viewing the playback, click this button to create a bookmark. It helps when you need to return to the point in time after you review all through the recorded videos. Note that the bookmarked video clips are free from storage recycles. They will not be erased when storage runs short and needs to be recycled.

Smart search II: Smart search II is an independent function. please refer to 2-16 Smart search for details.

Liveview: Click to return to Live view.

2. Right-click Menu: Right-click on the Playback screen to display this menu.

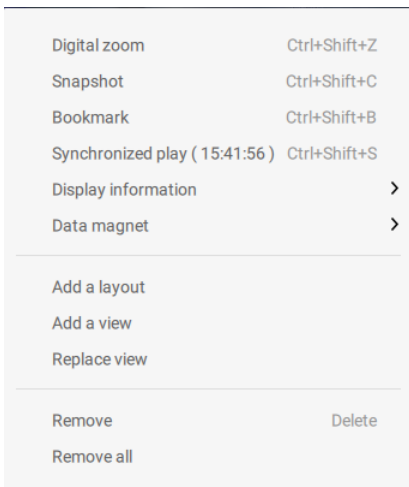

Digital zoom: If you find anything of your interest when viewing the playback, click this button to create a bookmark. It helps when you need to return to the point in time after you review all through the recorded videos.

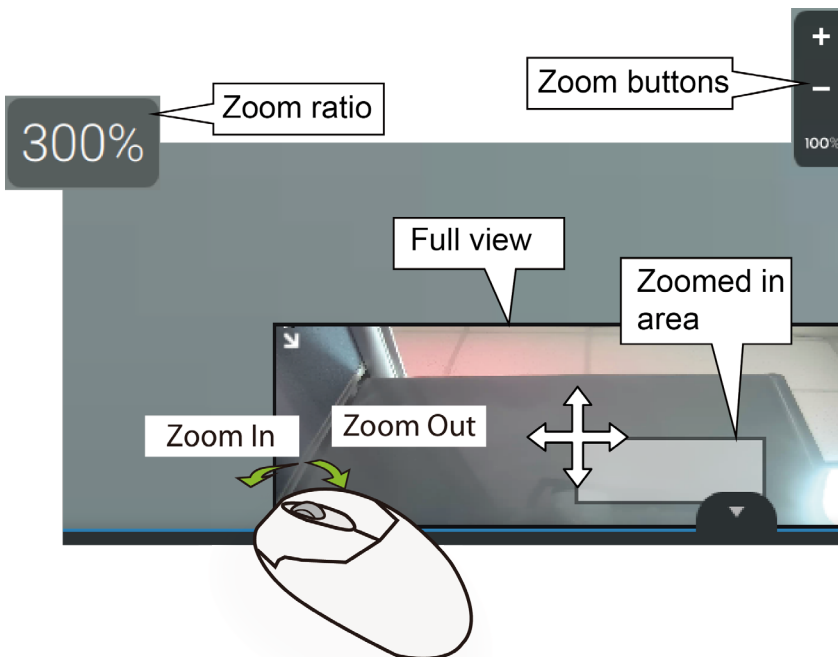

Snapshot: Click to take a snapshot. A small floating window will stay for 2 seconds. You can click the folder icon to access the snapshot files.

Bookmark: If you find anything of your interest when viewing the playback, click this button to create a bookmark. It helps when you need to return to the point in time after you review all through the recorded videos.

Synchronized play: When enabled, all cameras in the same view will be playing the video of the same point in time.

The following commands are general purpose commands.

Display information: By default, all display elements will appear on screen for all playback windows. You can use the Edit display information to select more display elements.

They include:

Status, Camera name, Server time, Codec, Resolution, Network throughput & FPS, Fit screen with ratio, POS transaction details (for POS), Data magnet data (Data overlay on screen / Hide data after idle), Motion detection, Rules (VCA), Rule name, Motion cells, Tracking block, Tracking dot, Exclusive area, People detection area.

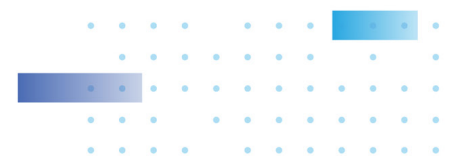
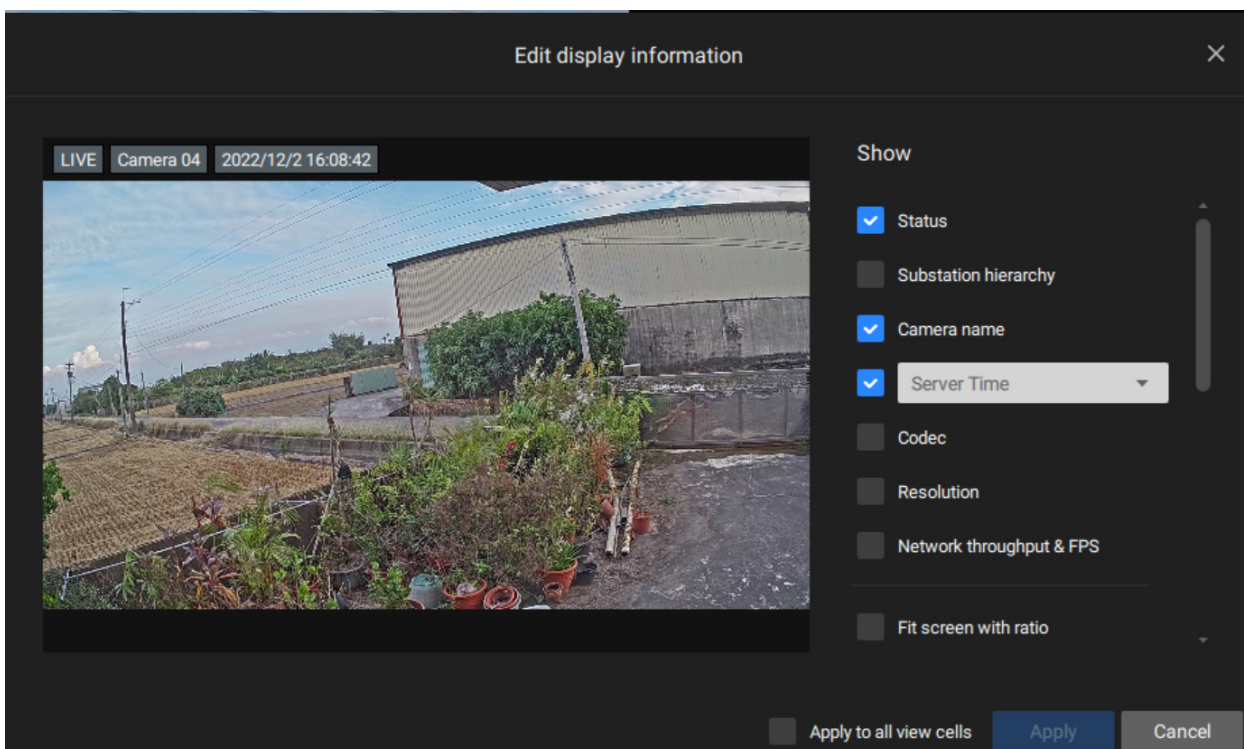

Data magnet: For 3rd-party applications, such as VIVOTEK's license plate recognition software, you can select to display different types of information. You can use the Edit display data to select or deselect the display elements.

Please note that the display elements can vary for different applications.

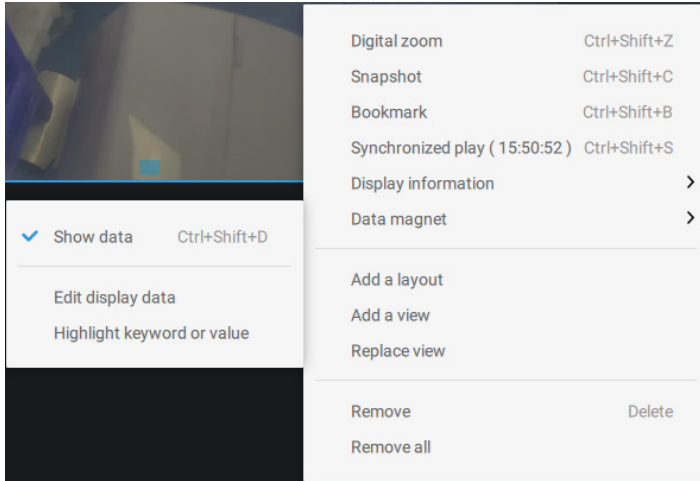

Below are the sample screens for applications implemented via the Data magnet.

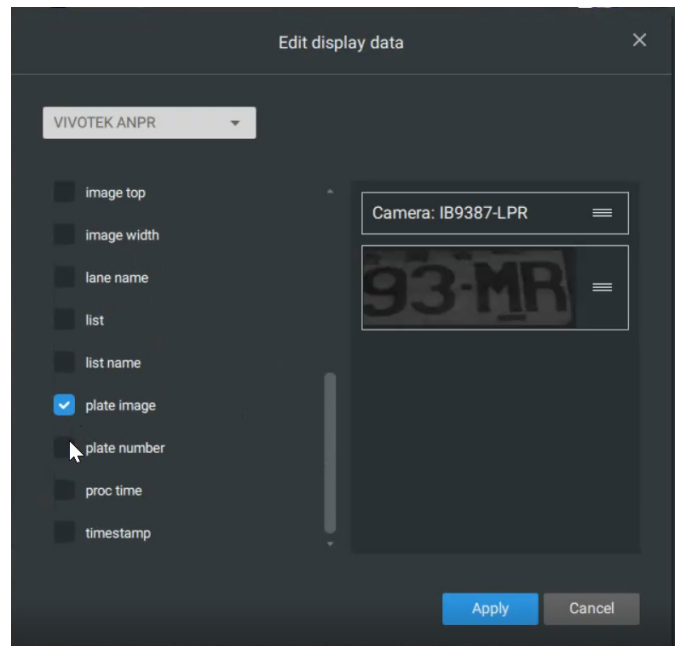
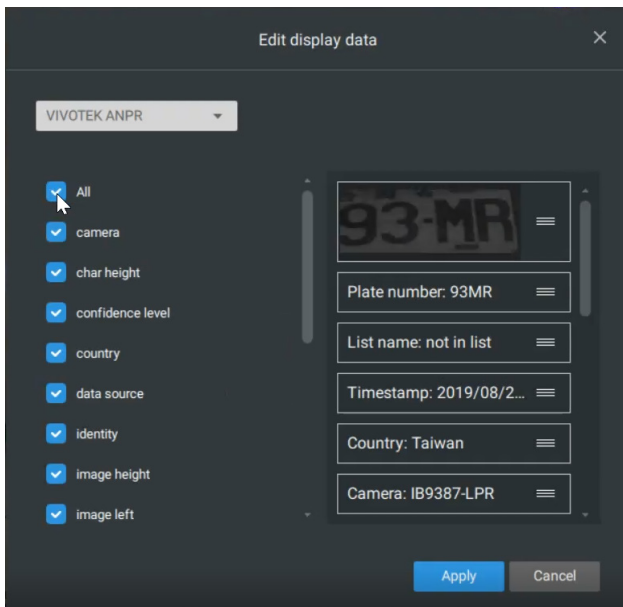

3. Timeline Panel: This panel appears when Playback is initiated.

Timescale is adjustable (minutes, hours, days, to a max. of 3 days) so you can easily find the required time period and begin playback from that point.

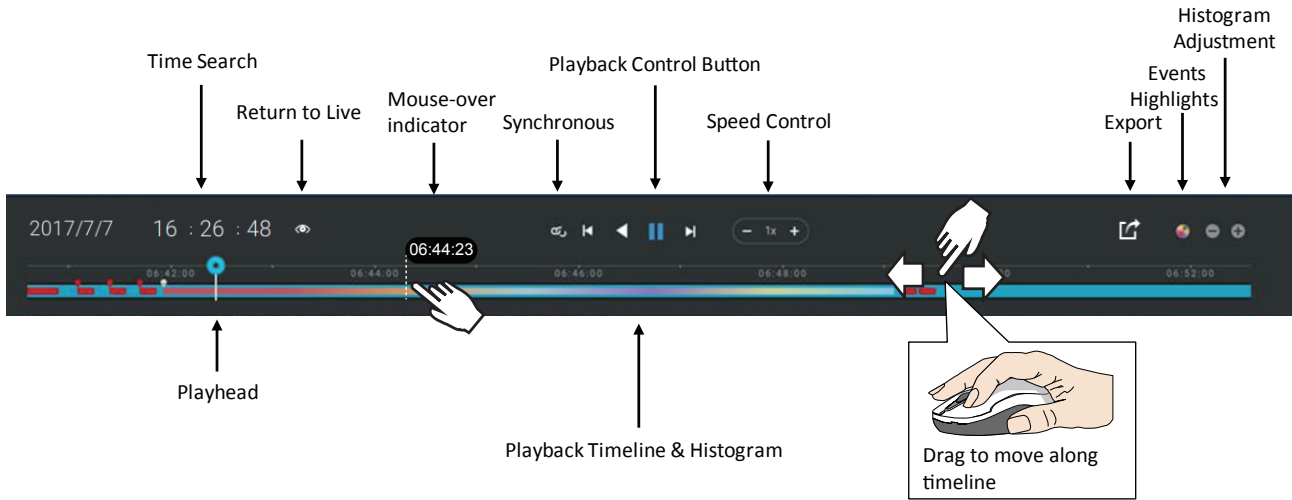

Starting from left to right, timeline control functions will be described as follows:

1. Time Search: Click on the current date to open a calendar. If you want to review videos recorded in another day, select it from the calendar.

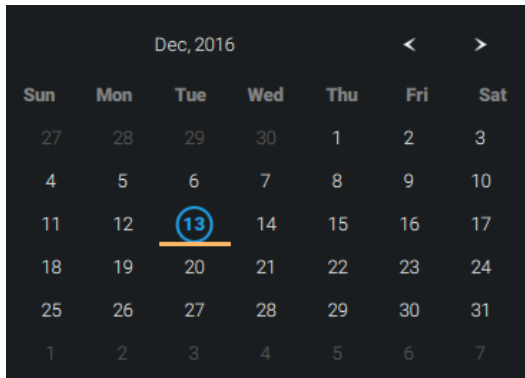

- Blue: days with recordings.
- Orange bottom line: Today.
- White: days with no recordings.



Click on the current time. You can use the arrow buttons to change the time you wish to playback, or simply enter a preferred number. You can also pull the playhead along the timeline.



Timeline magnification levels: The default time span is 6 hours. You can change the magnification level for easier browsing. Click the Zoom in and Zoom out buttons to change the timeline time span. The configurable time spans are shown below:

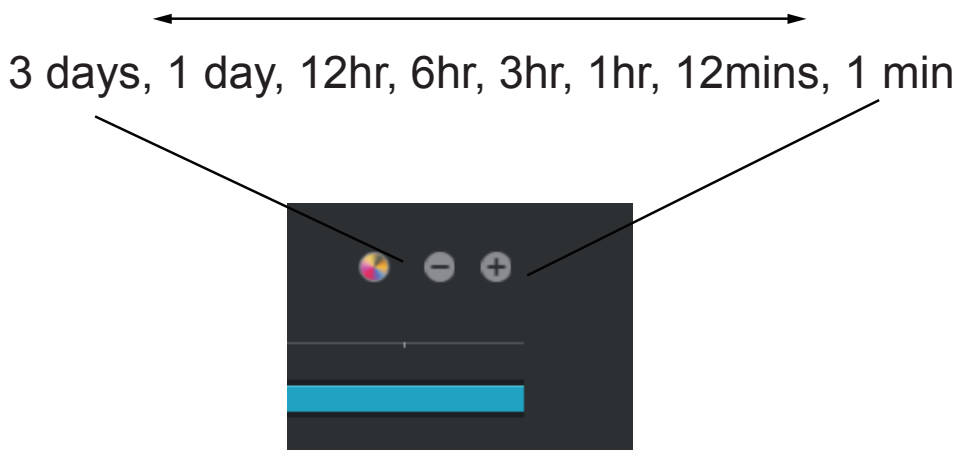

2. Playback control:

From left to right,

2-1. Synchronous play: This lets all cameras in the same view to playback video of the same point in time. If you perform synchronous playback on a multi-cell view, your computer can be stressed. It is recommended you create a new view with a 2x2 layout, select and insert camera views into it, and begin the Synchronous playback.

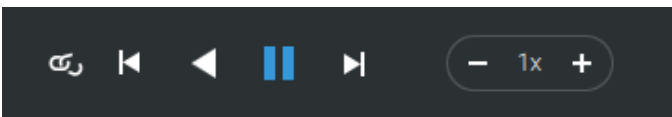

2-2. Frame by frame buttons: Click to move forward or backward to flick through the video frames. This may only display the I-frames.



2-3. Forward playback and reverse playback: Click to view the video in the forward or reverse playback manner.



2-4. Speed selector: The selectable speed ranges from 1/64x to 64x.

3. Export Clips: Click the Export Clips button . A range selector will appear. Pull the ends to include the time span you want to export. Note that each end of the selector, when clicked and selected, will turn white, and its location on the timescale is shown on the time line. When done, click the Start to export  button.



Depending on the length of video clips to export, it may take minutes to export. When the export is completed, a shortcut to the exported clips is shown. You may then open the folder where the clips are located.

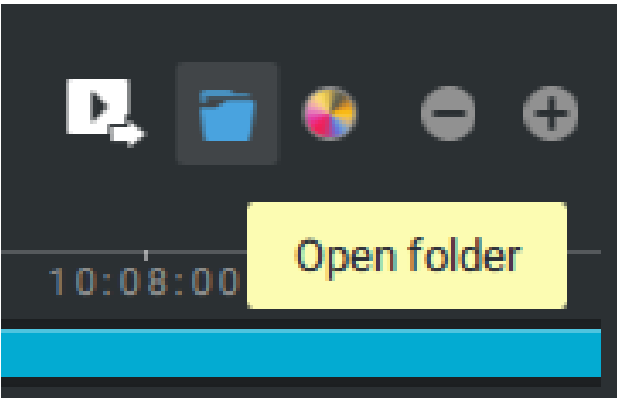

When you export a video, you can assign a password for the encrypted video. Once encrypted, you cannot play the video using ordinary video players. You can only play the video using VSS standalone player after you enter the correct password.

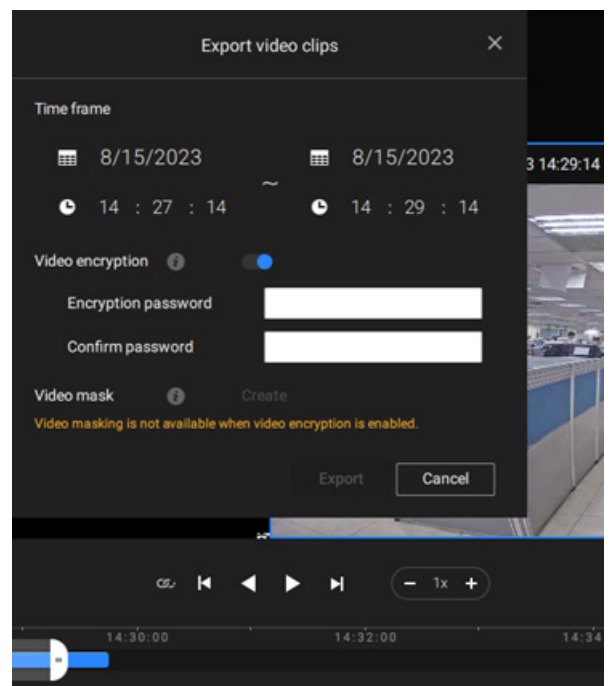
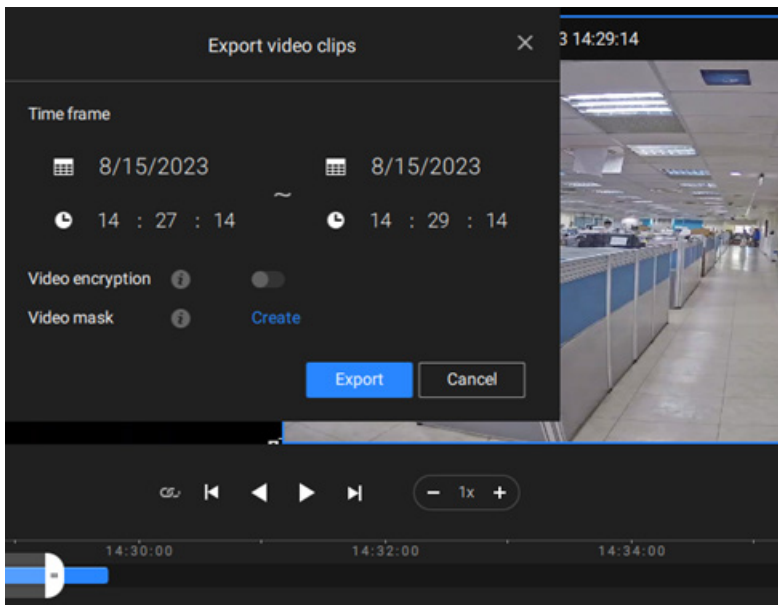

When video encryption is off (default), you can create video masks (available on VSS Professional only; black or pixelated) for specific time frames to protect privacy in the video to be exported.

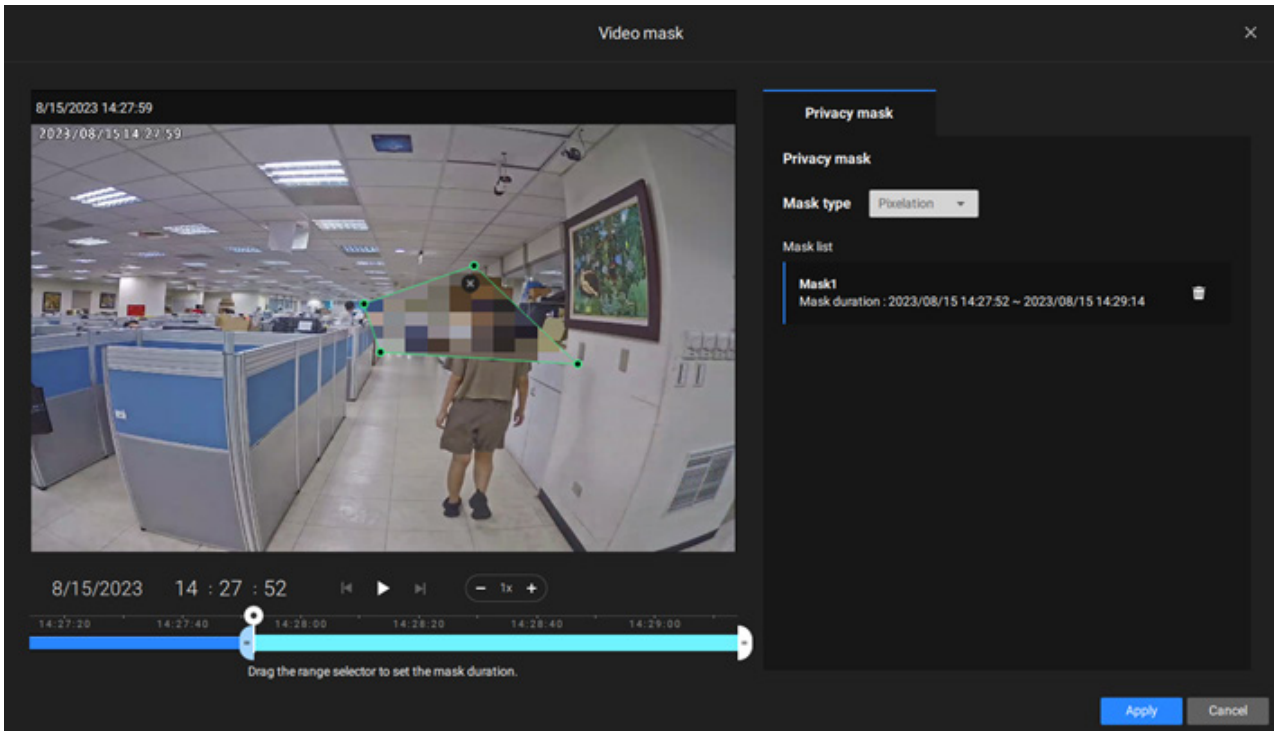

Event Highlights on timeline: Select one or all of the event types to display event tags on the timeline that match those have occurred in the past.

Note that on the VIVOTEK's Linux-based NVR, the timeline will display the occurrence of an event for a length of 10 seconds since its occurrence.

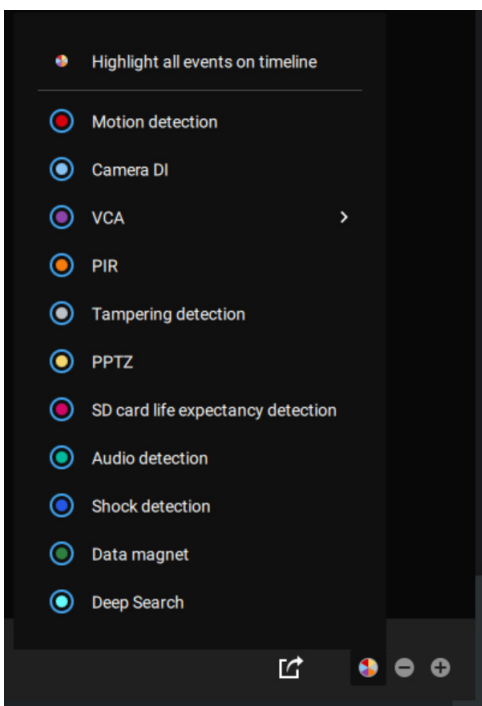

2-11. PTZ Control



PTZ control refers to the mechanical PTZ, which applies to cameras that are capable of pan and tilt directional control as well as zoom control.

To begin the PTZ control, click on the PTZ button .

A set of buttons will appear on the right side of the view cell, with functions arranged from top to bottom: Zoom in, Zoom out, Home, and PTZ control mode. Other advanced PTZ functions will appear in the bottom right corner of the view cell, including Focus, Zoom speed, Patrols, Presets, Pan, Tracking, and Stop.



Zoom in/out

By clicking the zoom in  or zoom out , you can adjust the optical zoom of camera, you can also use the mouse wheel on view cell to zoom in or zoom out.

Home

By clicking the Home , you can go back to the home position of the camera.

PTZ control mode

the default PTZ control mode is click and drag, which allows you to control pan and tilt by clicking and dragging your left mouse button across the view cell. A light blue trace will appear while you drag the mouse towards the direction you wish to move, the longer the trace, the faster the move. Note that while the camera is moving, you can change the move direction, keeping the mouse button held down. Release the button to stop moving.



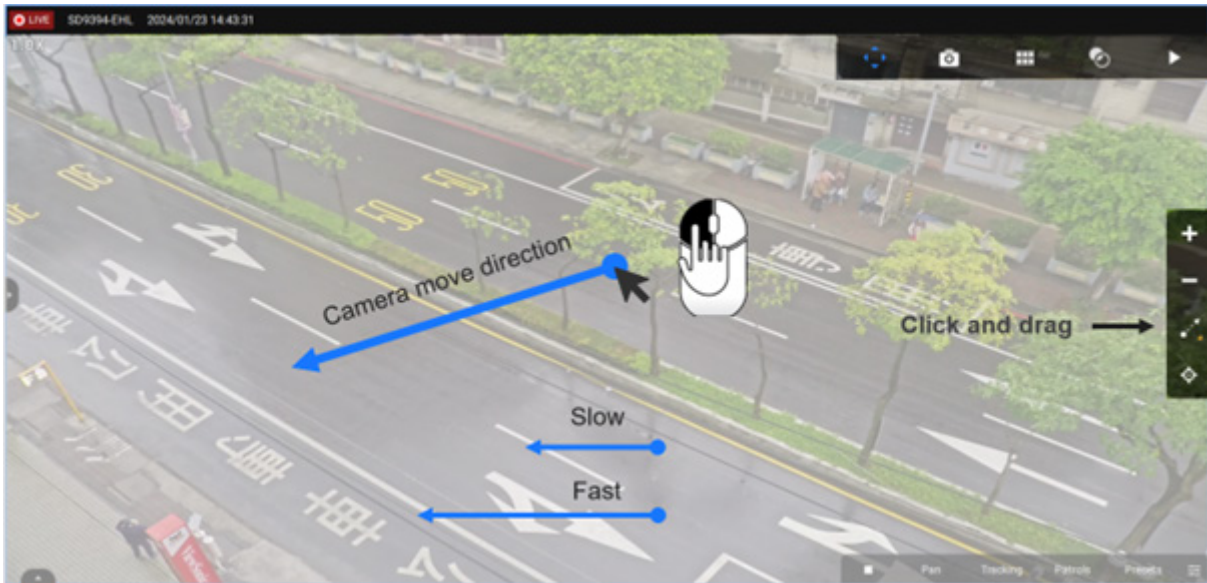

You can also click the PTZ control mode button to switch to area zoom mode, which allows you to draw an area on view cell for zoom in.

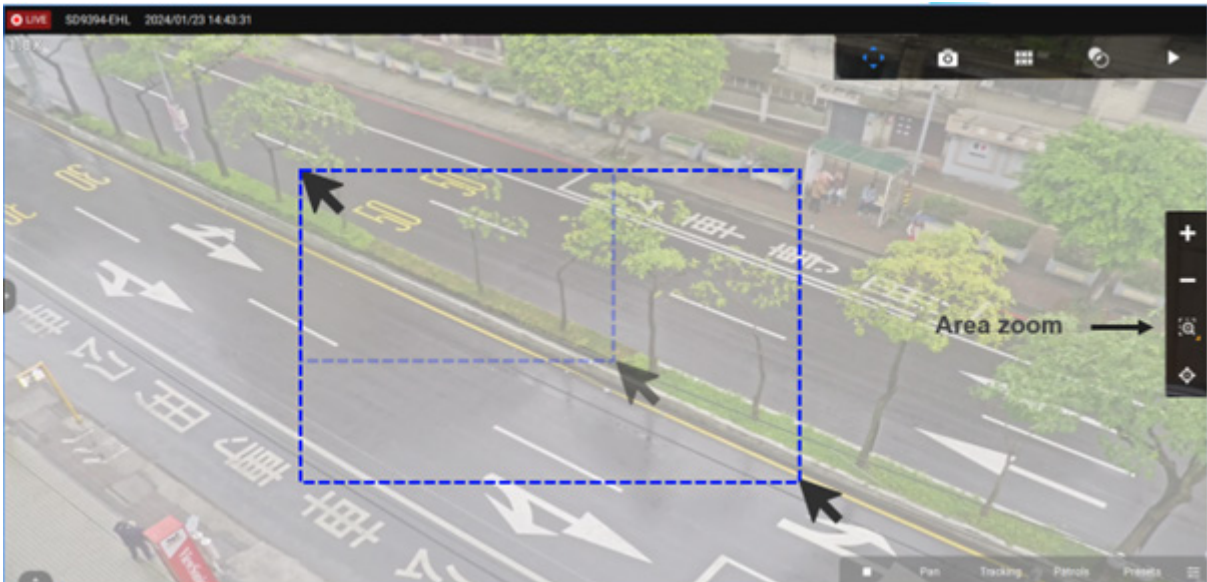

See Appendix C Joystick support if you use VIVOTEK's joystick.

Advanced PTZ functions

By clicking patrol and presets button **Patrols Presets**, there will be a dropdown list that allows you to select the patrol or preset. By clicking the stop button **■**, you can stop the movement or action of the camera.

By clicking the tracking button, for cameras that support smart tracking advanced, there will be a preset list that allows you to select which preset you want to enable tracking. For other cameras that support smart tracking or auto



tracking, the camera will start tracking with current position.

You can also adjust the zoom speed, focus and focus speed manually or start pan

in the button .

See Appendix H Smart tracking for how to enable the smart tracking feature.



2-12. Fisheye Camera Dewarp Modes

By default, a circular view is displayed when a fisheye camera is successfully connected. To display Regional, Panoramic, or the combination of different views,

1. Mouse over the view cell of a fisheye camera.
2. The onscreen control panel will appear. Click on the Fisheye button.
3. The Dewarp mode pane will prompt. Select a dewarp mode.

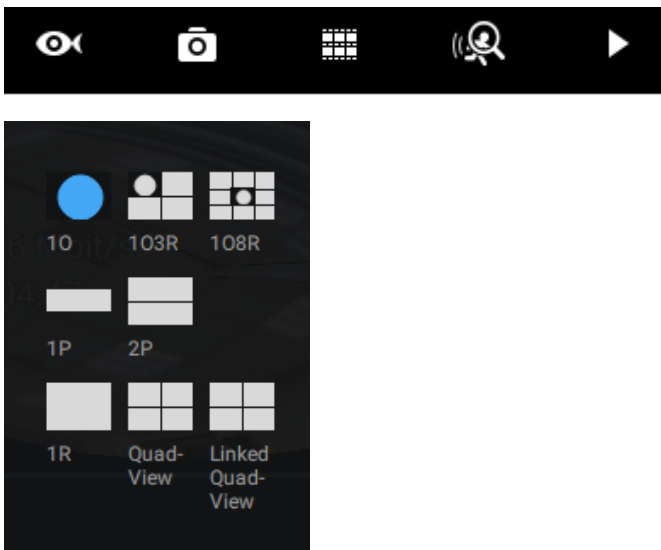

The display modes available are: 1O (Original), 1P (Panoramic), 1R (Regional), 2P (2 Panoramic), 1O3R (1 Original & 3 Regional), 4R (Quad Regional), 1O8R (1 Original & 8 Regional), and 4R Pro (4 Proactive) modes.



Fisheye Display Modes: below are conceptual drawings for different display modes.

1O (Single Original) Display mode:

An Original oval view covers the hemisphere taken by the fisheye lens.

1O View (Original View)

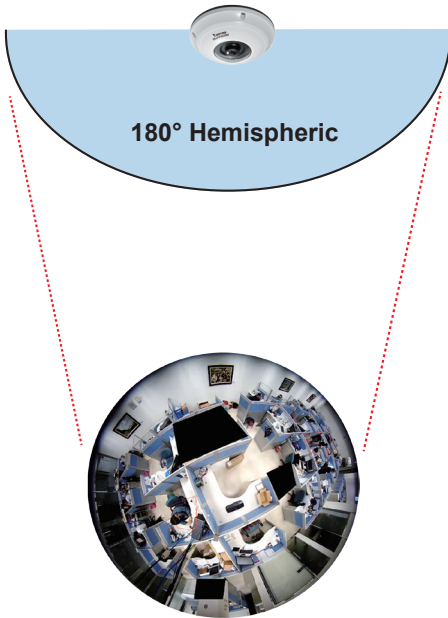

1R (Single Regional) Display mode:

A Regional view crops a portion of the hemisphere as a region of interest. You can zoom in or out or move the view area elsewhere from on the regional view.

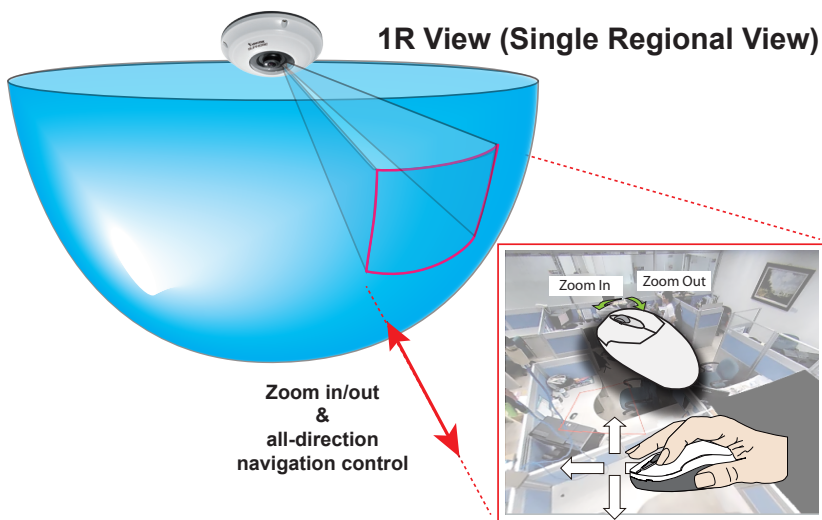

A Regional view is dewarped, by correcting images from the distorted oval view to a rectangular and visually proportional image.



1P (Single Panoramic) Display mode:

With image correction algorithms in firmware, the hemispheric image is transformed into a rectilinear stripe in the 1P display mode. Viewers can use the PTZ panel or simply use mouse control to quickly move through the 360° panoramic view.

Note that the 1P view is apt for an overview, the Zoom in/out function does not apply in this mode.

1P (Panoramic) Mode Screen Control



2P (2 Panoramic) Display mode:

Two dewarped rectangular views are placed one on top of another each showing 180 degree of panoramic view. The 2P view looks like the upper view shows the front of hemisphere, and the lower view the rear half of the hemisphere.

2P (Panoramic) Mode Screen Control

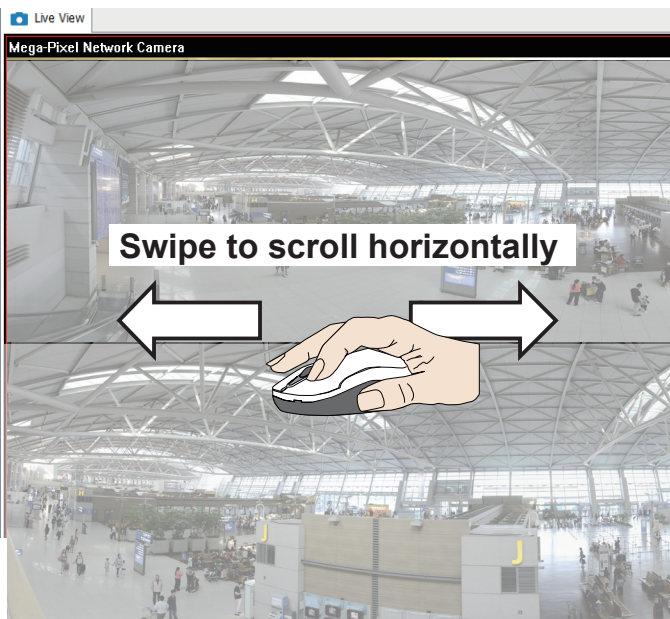

1O3R (One Original & 3 Regional) Display mode:

Fisheye cameras also support the display of multiple regional views taken from within the same hemisphere, and they can be displayed with or without an Original view in its view cell.

3R View (Regional View)

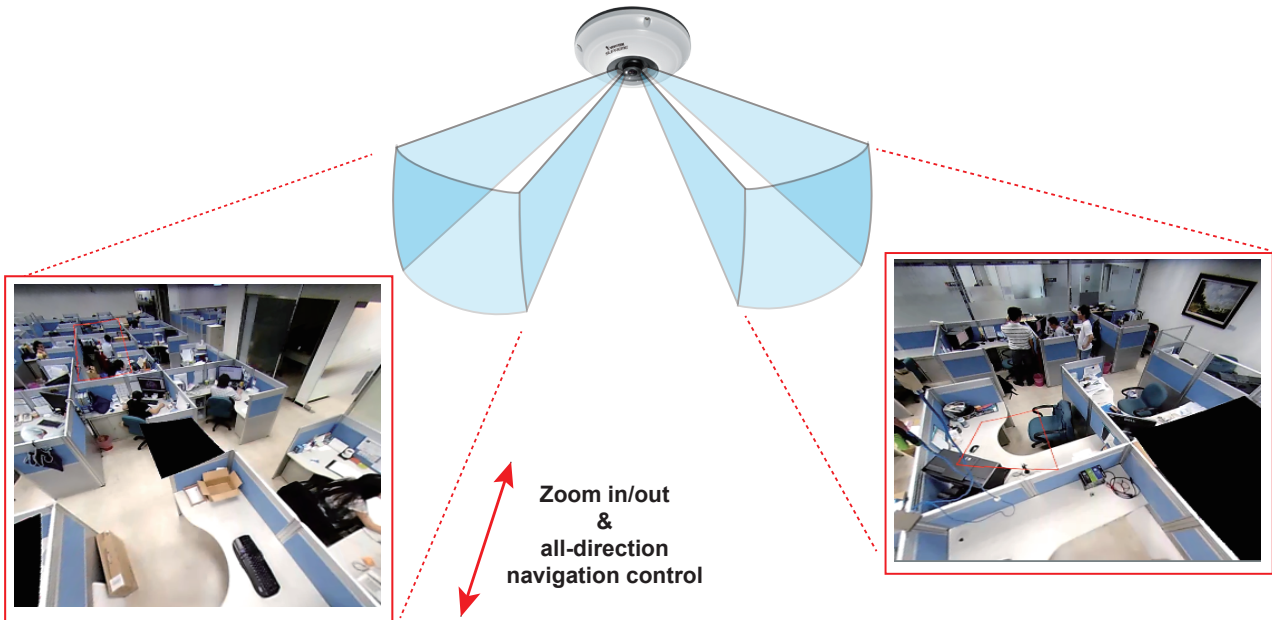

* Only two regional views are shown for simplicity reason

NOTE:

The various display modes require the support of D3D technologies by your display card on the LiveClient or Playback station. Most off-the-shelf display cards today support this feature.

The onscreen mouse control is very agile. Therefore, use the PTZ panel for more delicate moves in a field of view. Pan and Patrol moves are also supported if you have configured preset PTZ positions in the camera's firmware. Note that the Pan move takes place in the Panoramic and Regional views, while the Patrol function through preset positions applies only in the Regional views.



PTZ Mouse Control

The "Mount type" setting also determines the display modes available to your display modes. Please refer to fisheye camera's User Manual for more information.

A highly versatile mouse control is implemented with fisheye cameras. The same control takes effect on a browser management session, on the LiveClient utility, and even on a video playback screen. See the drawing below for how it works.

You can click and hold down the left mouse button to quickly swipe through the field of view, change the view angle, or use the mouse wheel to zoom in/out on a region of interest. However, the PTZ mouse control is only available in the "R" (Regional) mode. In the Panoramic mode, you can only scroll horizontally across the 180° or 360° panoramic view.

103R (Original & Regional) Mode Screen Control

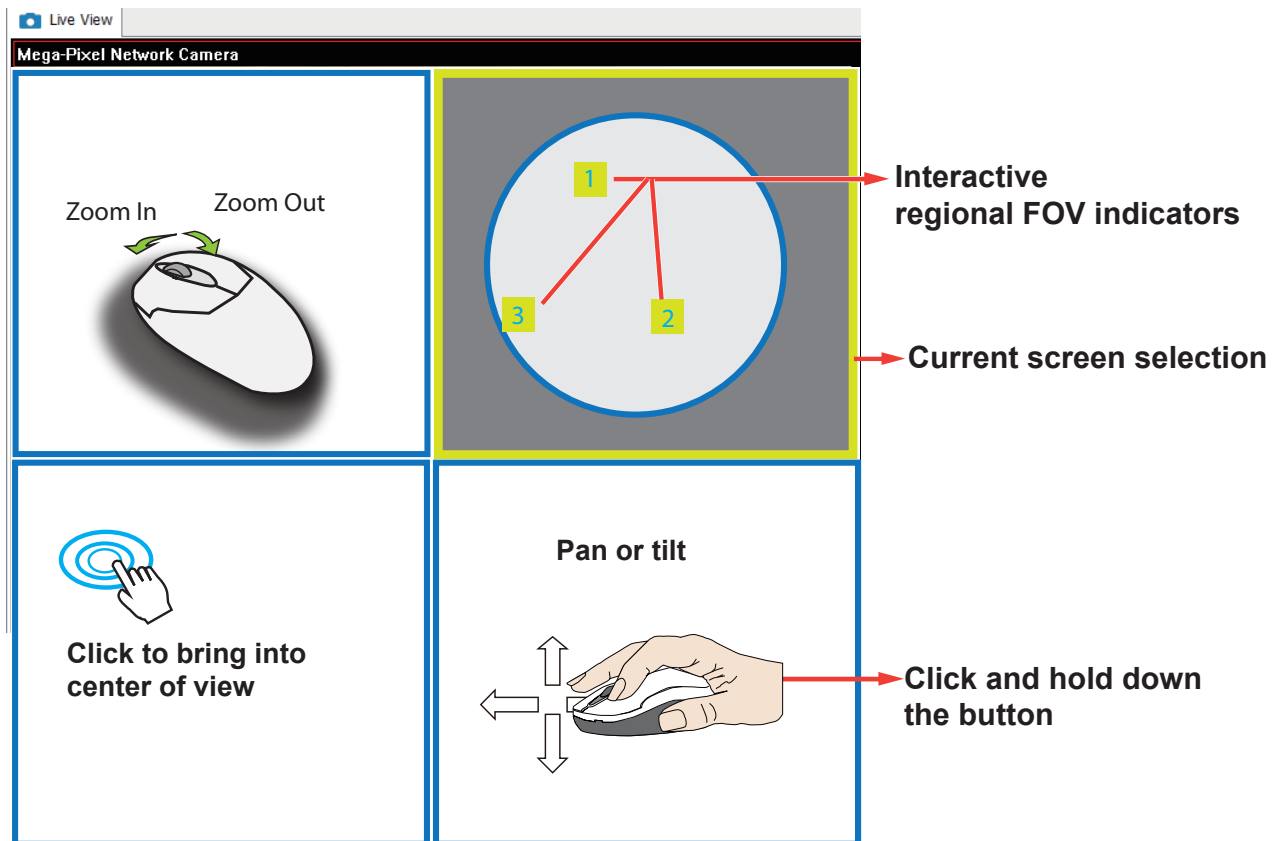

Below are the conceptual drawings for the other display modes. The available display modes can differ with different mount types:

Regular: 1O, 1P, 1R, 1O3R, 4R.

Wall mount: 1P2R, 1P3R.

For more information, you can refer to fisheye camera's user documents.

4R (Quad Regional) Display mode:

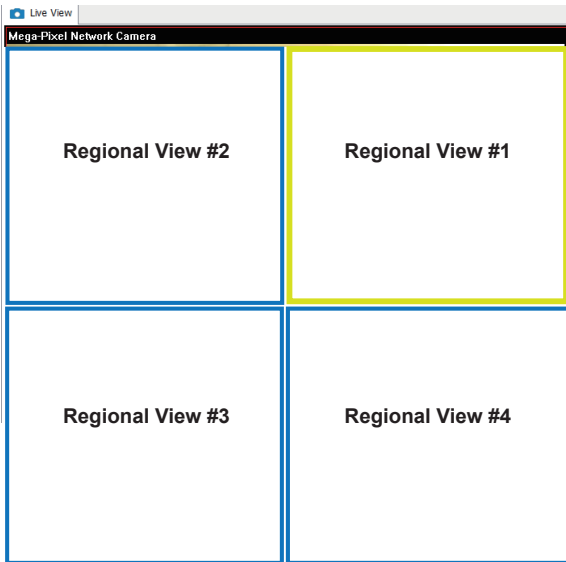

4RPro (4 Regional Proactive) Display mode:

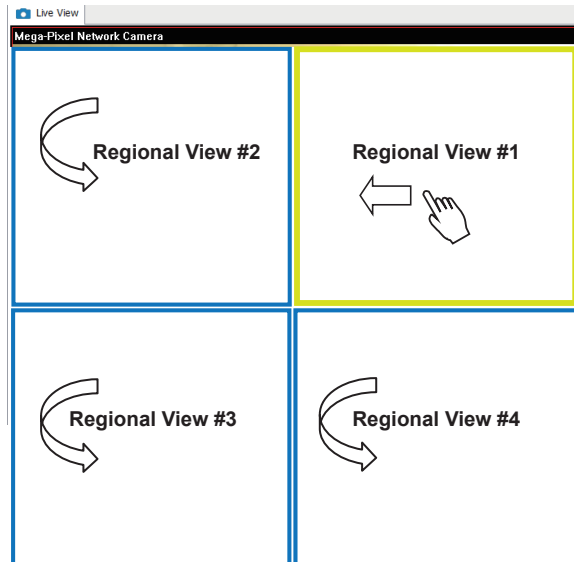

1O8R (One Original & 8 Regional) Display mode:

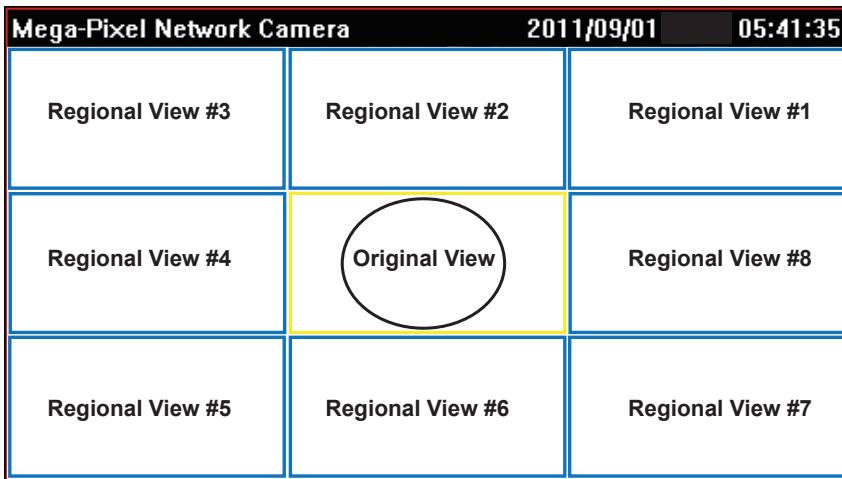

3rd-party Fisheye Dewarp

Via manual calibration, users can utilize dewarp functions for 3rd-party fisheye cameras through the Enable fisheye lens dewarping, and select a mount type. You can then align the blue circle with the fisheye's circular view.

When the calibration is done, you can select different dewarp modes in VSS using the transition button on the upper right of the view cell.



2-13 Alarm

The Alarms can be configured to perform a series of actions when different events occur. Alarms can be used to automatically react to possible threats. For example, the VSS server can start a recording or send an Email notification when Motion detection is triggered.

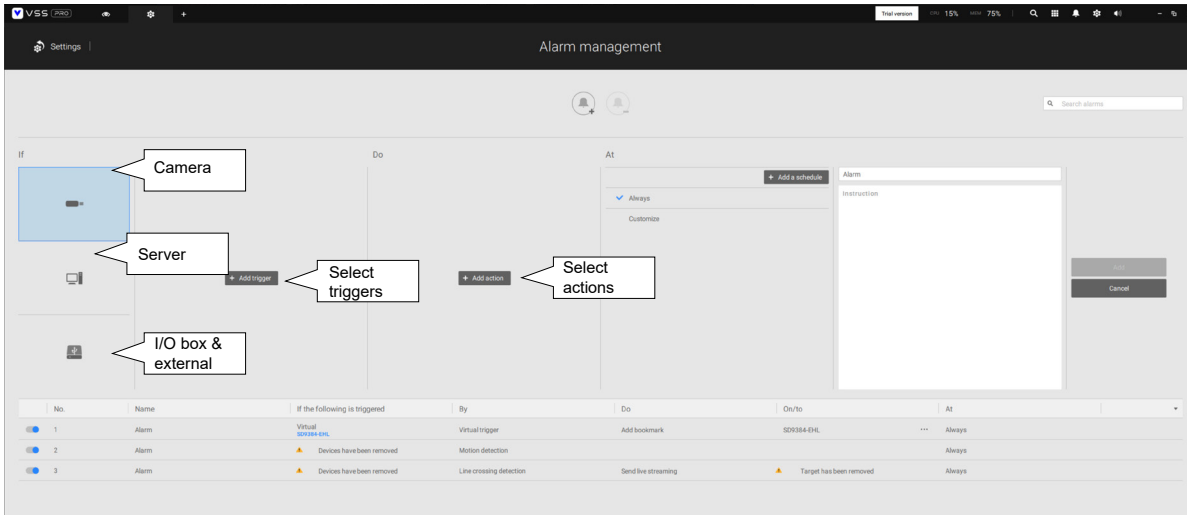

A wide variety of triggering conditions can be applied, including:

1. Camera triggers

General	
<input type="checkbox"/> Motion detection	<input type="checkbox"/> IR (Infrared)
<input type="checkbox"/> Camera DI	<input type="checkbox"/> PIR (Passive Infrared)
<input type="checkbox"/> Camera DO	<input type="checkbox"/> Tampering detection
<input type="checkbox"/> Temperature	<input type="checkbox"/> Stop recording
<input type="checkbox"/> Recording error	<input type="checkbox"/> Audio detection
<input type="checkbox"/> Video loss (Video server only)	<input type="checkbox"/> Shock detection
<input type="checkbox"/> SD card life expectancy detection	
Video Content Analysis	
<input type="checkbox"/> Line crossing (VCA)	<input type="checkbox"/> Intrusion detection
<input type="checkbox"/> Loitering detection	<input type="checkbox"/> Face detection
<input type="checkbox"/> Missing object detection	<input type="checkbox"/> Unattended object detection
<input type="checkbox"/> Crowd detection	<input type="checkbox"/> Smart tracking
<input type="checkbox"/> Zone detection	<input type="checkbox"/> People running detection
<input type="checkbox"/> Parking Violation detection	<input type="checkbox"/> Restricted Zone detection
Trend Micro IoT Security	
<input type="checkbox"/> Brute force attack	<input type="checkbox"/> Cyber attack
<input type="checkbox"/> Quarantine event	



Note that some of the triggers require that you open a web console to individual cameras. For example, VCA and Motion detection windows have to be manually configured on each camera before they can be configured in the Alarm settings.

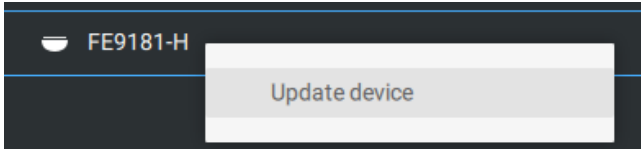

If you select a trigger and you cannot find a corresponding device, you need to open a web console to that device. Make sure the corresponding VADP is running. Open the VSS device tree, right-click on the device to perform a manual refresh "Update device" to acquire the latest configuration update.

If a triggering condition is associated with event recording, an event prompt will pop up on the screen when a triggering condition is met. For example, the number of people exceeds a preset threshold in a Crowd Detection configuration. The sample prompt is shown below. The related footage can be played back by clicking on the event entry.

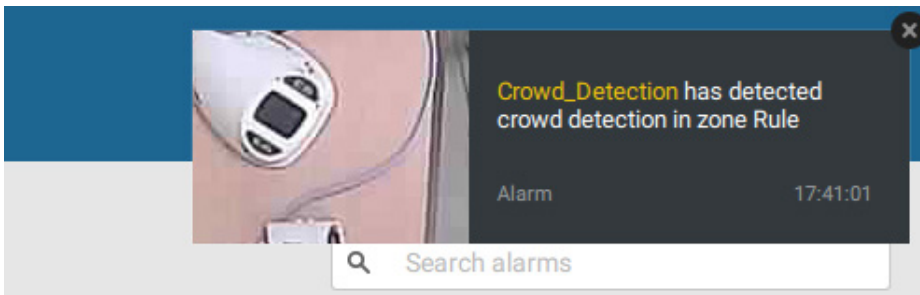

The alarm notification can be turned off by clicking on the Alarm tab. You can enter the time span when you do not want to receive notifications and the notifications will automatically turn on after the time span. Enter the number in the mins field. The max. time span is 9,999 minutes.

The notification configuration is kept on the client computer.

When the Alarm notification is turned off, the Alarm tab icon is greyed out .

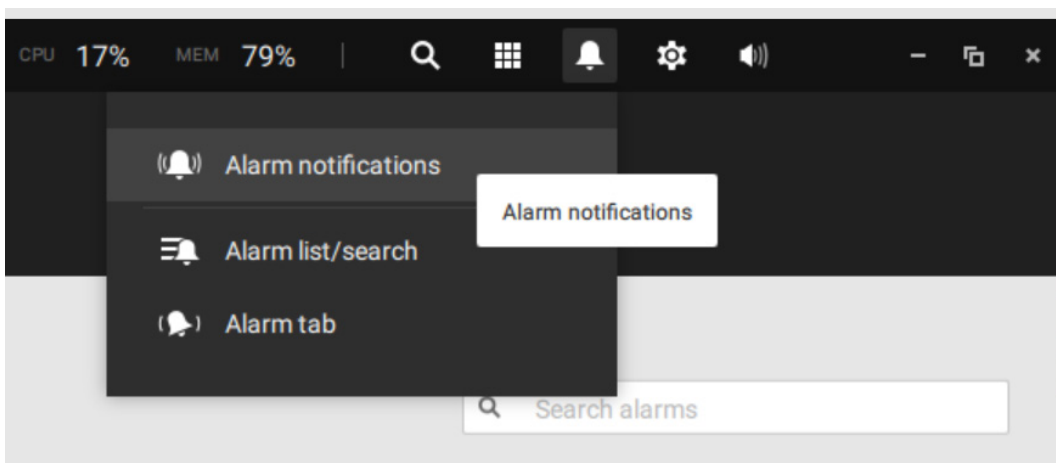

Individual VSS clients can configure which kinds of alarms can be delivered to them by selecting the alarm types listed in "Turn on the notifications you want to receive." When the individual alarms are turned off, the following client-side alarm actions will be disabled on the client computers:

1. Notification.
2. Send live streaming.
3. Go to E-map.
4. Sound the alarm.

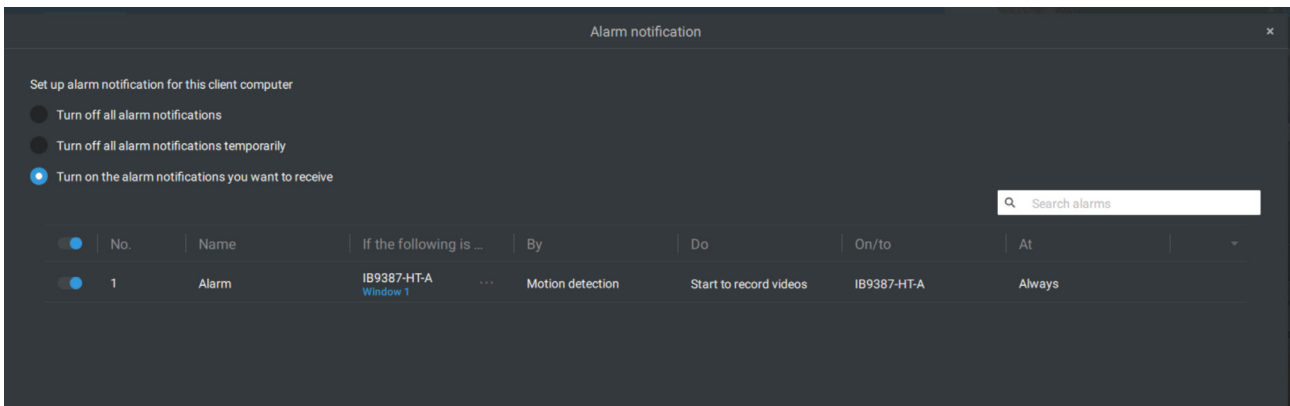
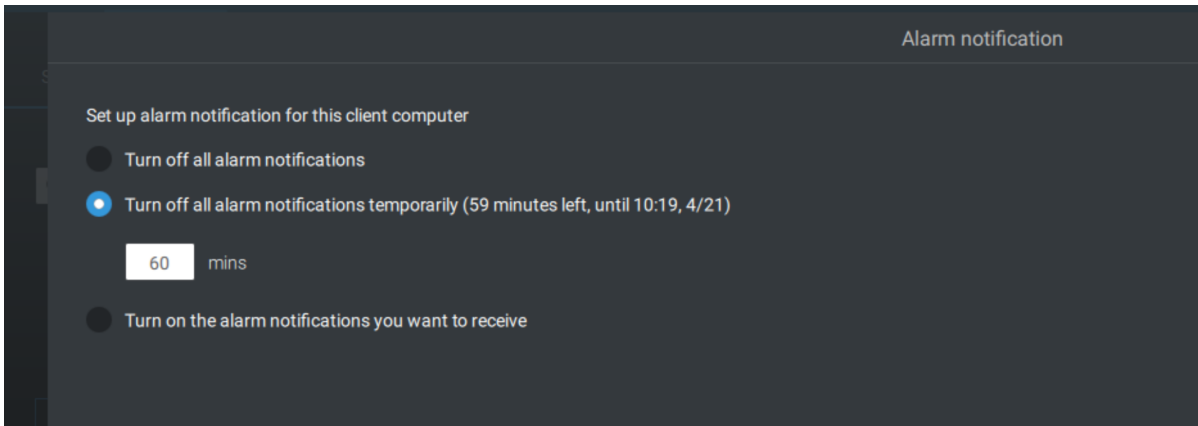

Note that the default for the alarm notification is "Turn on the alarm notification you want to receive." If you turn off the alarm notification, you need to re-activate it after you turn off the notification the first time.



2. Server and NVR triggers



<ul style="list-style-type: none"> ● Network disconnected 	<p>These can be used to send maintenance notifications.</p>
<ul style="list-style-type: none"> ● Storage failure 	
<ul style="list-style-type: none"> ● Storage full 	
<ul style="list-style-type: none"> ● Fan status 	
<ul style="list-style-type: none"> ● GPS disconnected (Mobile NVR) 	<p>The GPS and G-sensor related options apply to the Mobile NVR that comes with the GPS and G-sensor. GPS can be used to track the speed and location of a vehicle, while the G-sensor can be used to detect abnormal impact.</p>
<ul style="list-style-type: none"> ● Abnormal G-sensor motion (Mobile NVR) 	
<ul style="list-style-type: none"> ● Speeding (Mobile NVR) 	
<ul style="list-style-type: none"> ● Number of remaining people 	<p>For VCA-capable cameras, the alarm can be triggered when the number of people staying within a specific area has exceeded the preset threshold. For example, when too many people are waiting in line in front of a cashier.</p> <p>This function requires appropriate configuration on the counting camera(s).</p>
<ul style="list-style-type: none"> ● Brute force attack (Trend Micro IoT) 	<p>These can be configured as alarm triggers to notify the administrator that malicious attacks have occurred. Note that these triggers are available with NVRs that come with the protection of Trend Micro IoT packages.</p>
<ul style="list-style-type: none"> ● Cyber attack (Trend Micro IoT) 	
<ul style="list-style-type: none"> ● Quarantine event (Trend Micro IoT) 	

* Note that you should use the pull-down menu to select a triggering condition, and then click to select a mobile NVR.



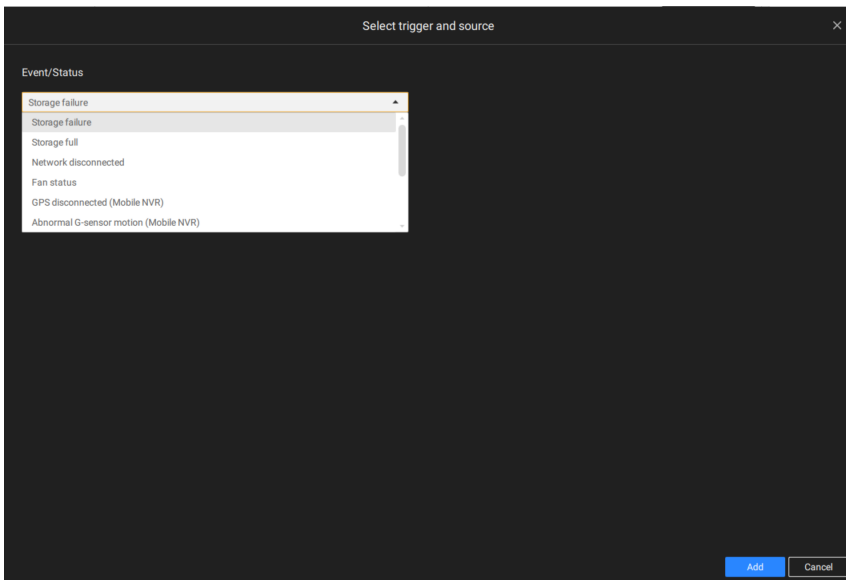

Note that the alarms will be received into the Alarm list window. The previous Alarm Search window is replaced by the Alarm list function.

The Alarm tab window is used to display the live video stream when an alarm is triggered, and its responding action is configured as "Send live streaming."



For I/O box configuration, please refer to the I/O Box page.

3. I/O box and TCP triggers

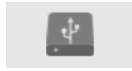

●	DI/DO Device DI	This applies when an external I/O box is applied, e.g., Advantech's ADAM I/O box.
●	DI/DO Device DO	
●	TCP Message	TCP message comes from the peer VSS servers or external sources (such as an access control system) via the analysis of received TCP message over the 3444 port. This is a paid feature.
●	Data Magnet	Triggering conditions can be acquiring data from 3rd-party software, such as the character height, image width, list, list name, country, from an LPR software, etc.
●	Virtual trigger	A virtual trigger allows users to create a button on live view to trigger Alarm actions, e.g., go to a camera preset, add bookmark, play an audio file, send HTTP requests, etc.

To configure a TCP message trigger,

Select TCP message as a trigger type, and enter a description, such as a short term, for VSS to listen and analyze data packages.

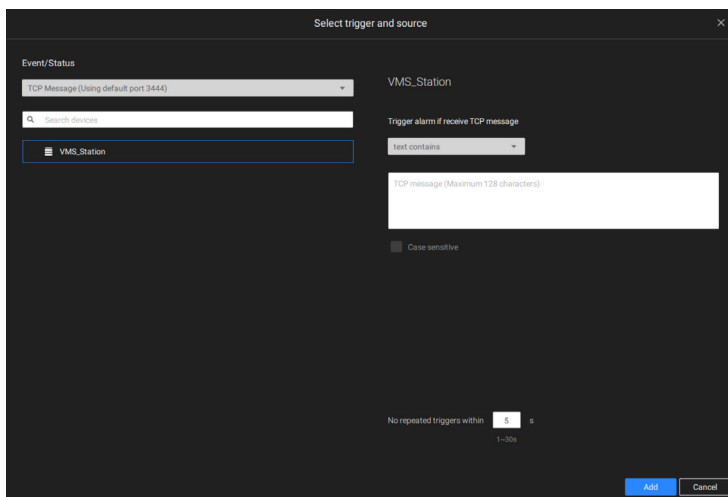

Below are the messaging parameters:

1. **text contains:** Messages will be received if some of the textual messages match the keywords.
2. **text matches:** Textual messages must be exactly identical.
3. **Case sensitive:** The upper or lower cases letters used in the messages must match within the messages.

You can use Telnet to send a small amount of data matching the term you entered in the TCP message configuration window. A TCP message event will be triggered, and you should see the event prompt as follows.

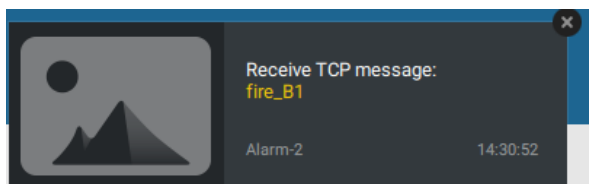

Virtual triggers have the following benefits:

1. More operation control, e.g., got to camera preset, add bookmark, play audio file with network audio devices.
2. Integrating 3rd-party systems and devices, using the Send HTTP requests, Set DO status commands.

To configure a Virtual trigger,

Go to Settings > Alarm > Add alarm.

Select the External device event, and then click on the Add trigger button.

The Select trigger and source window will prompt.

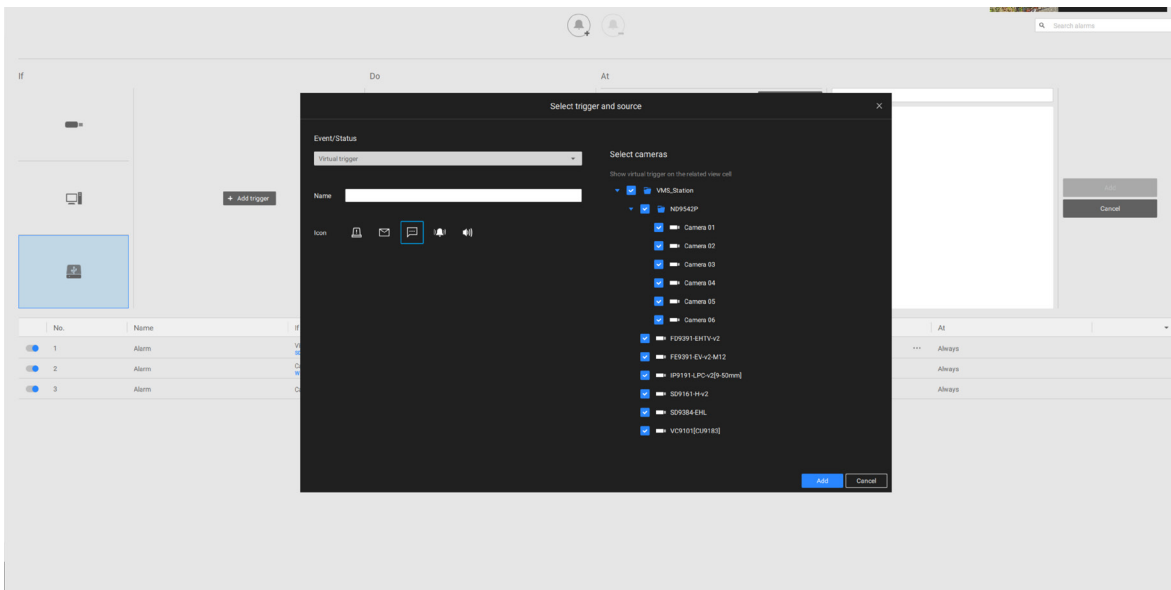

Select the alarm action.

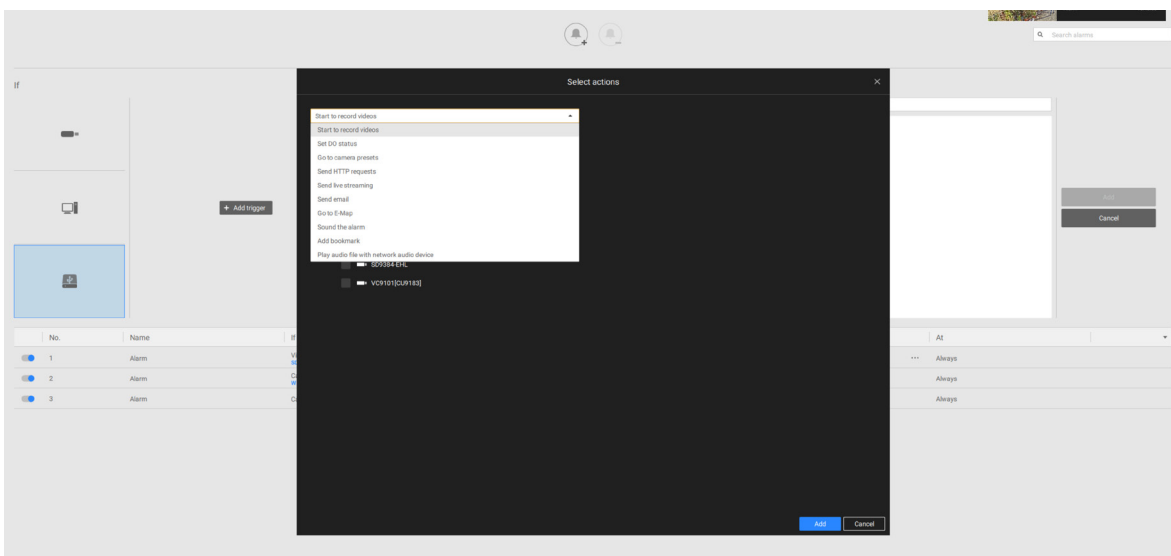

With a pre-configured virtual trigger, a trigger button appears on the live view.



When activated, all of virtual trigger buttons will appear allowing you to perform the associated actions.

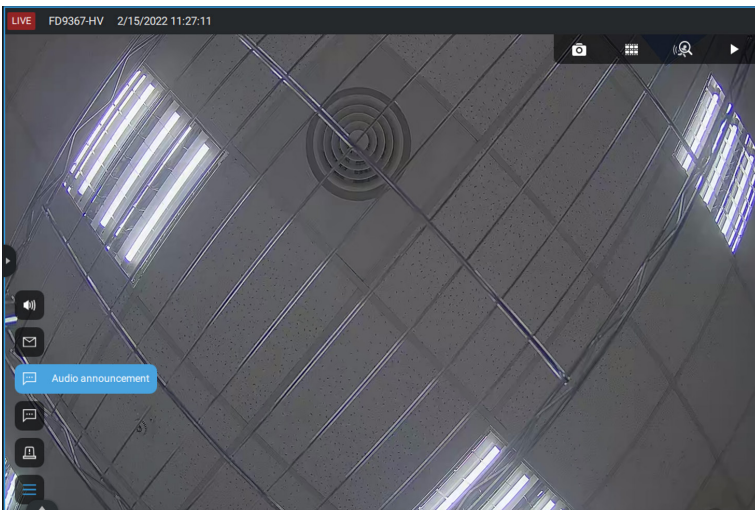

The available actions include:

<input type="checkbox"/>	Start to record video	<input type="checkbox"/>	Send HTTP requests
<input type="checkbox"/>	Set DO status	<input type="checkbox"/>	Send live streaming
<input type="checkbox"/>	Go to camera presets	<input type="checkbox"/>	Send email
<input type="checkbox"/>	Go to E-map	<input type="checkbox"/>	Sound the alarm
<input type="checkbox"/>	Add bookmark	<input type="checkbox"/>	Play audio file with network audio device
<input type="checkbox"/>	Send mobile notification		

The [Start to record video](#) will record a video clip of the length of 10 seconds (default) on the occurrence of an event. The event recording pre / post event time is configurable. Except for Stop recording, all the other triggering conditions can be associated with this action.

The [Set DO status](#) will activate a DO connection. For example, to light an illuminator or sound an alarm.

You can select a camera, and its DO pins will appear on the right. You can configure the duration of the DO trigger, e.g., 15 seconds.

If no Trigger period is configured and when there are multiple instances of DO trigger, administration troubles may occur. Use the arrow marks to configure a trigger period. You may also manually enter a number.

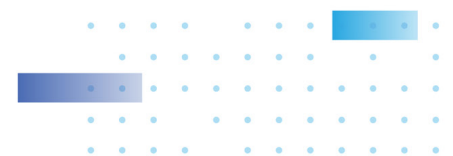
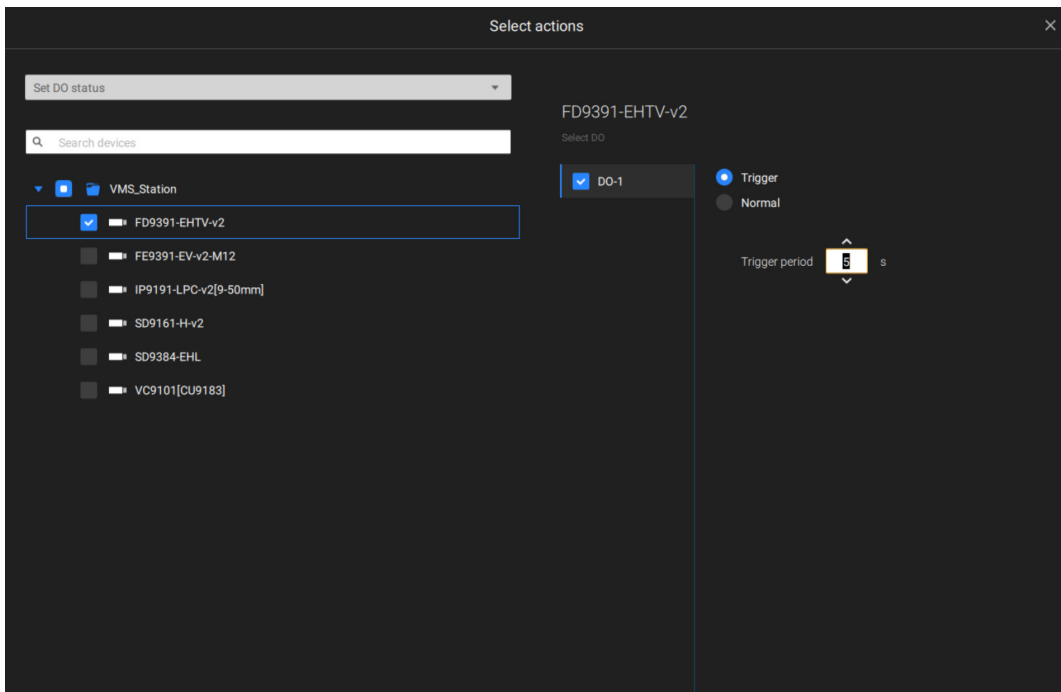

The [Send live streaming](#) action will bring up a video prompt to the Alarm tab window, showing the realtime video feed from a specific camera.

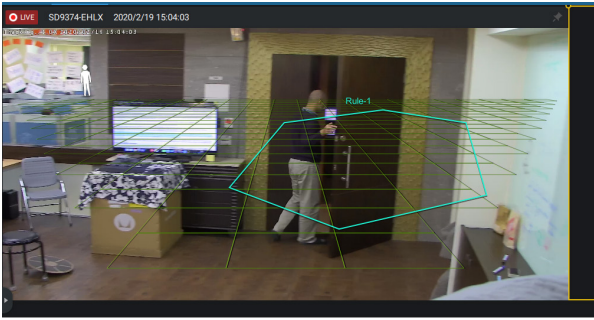

The [Go to camera presets](#) requires you to configure preset points on a PTZ camera before the Alarm configuration, such as a speed dome. Once triggered, the PTZ camera lens will move to a preset position.

The VSS server automatically disables unavailable options. For example, when the DO option is selected, the cameras that do not support DO connections will be hidden.

The [Send email](#) opens a configuration page where you should enter valid email addresses as sender and recipients. It is required that you configure an SMTP server for mail delivery in Settings > SMTP. Enter Subject and contents. Select the checkbox for including a snapshot of the event. When done, click Add to enable the action.

The [Go to E-map](#) opens a pre-configured E-map of where the triggering condition occurs. The user can then click on the camera icon on the E-map for an instant viewing.

The [Add bookmark](#) function saves a video clip of a 10-seconds length. Once triggered, you can open a new view tab > Search > Bookmark search to find the existing bookmarks. The bookmarked video clips will not be recycled during the storage cleaning cycles.



The **Sound the alarm** action provides 5 alarm sounds that will be sounded on the VSS client or server. Your VSS client or server should have speakers for playing the audible alarm.

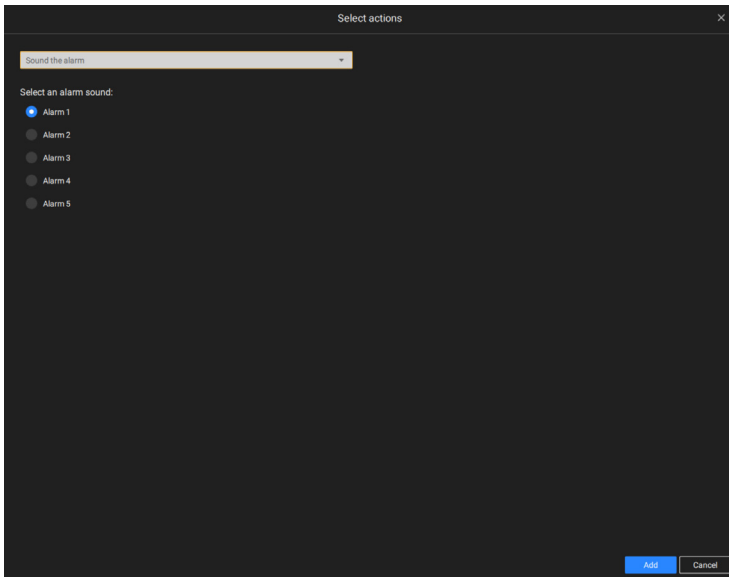

A reachable Mail server and Email accounts must be provided before you can apply the settings.

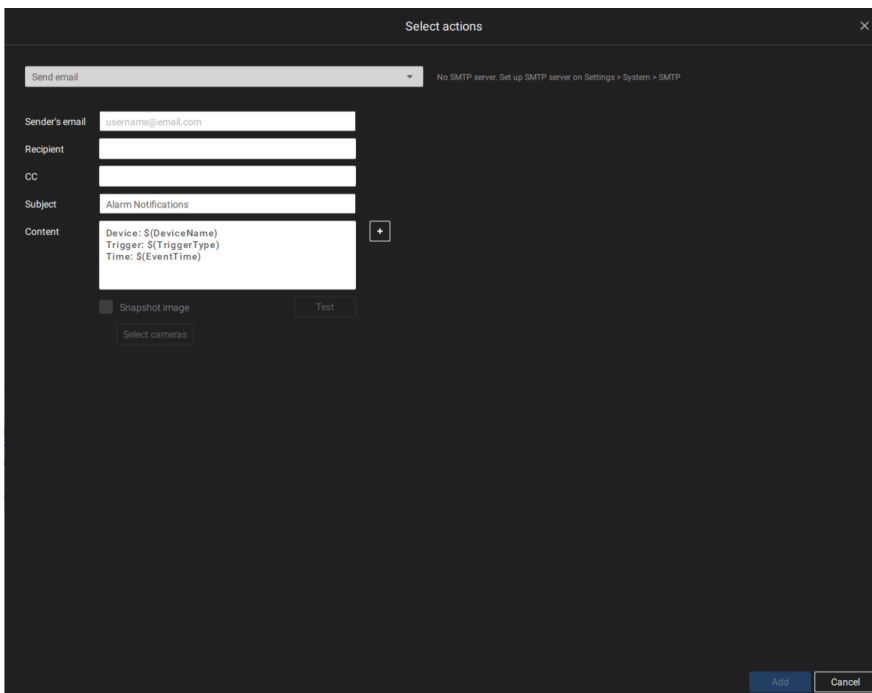

Send mobile notification, by default, pushes instant alarm contents to the iViewer mobile app on the smartphones of users. Meanwhile, the User-defined roles option is available (only on VSS Pro) for choosing a set of roles and saving the set as a role profile. So, it is easier to assign a user to a user-defined role.

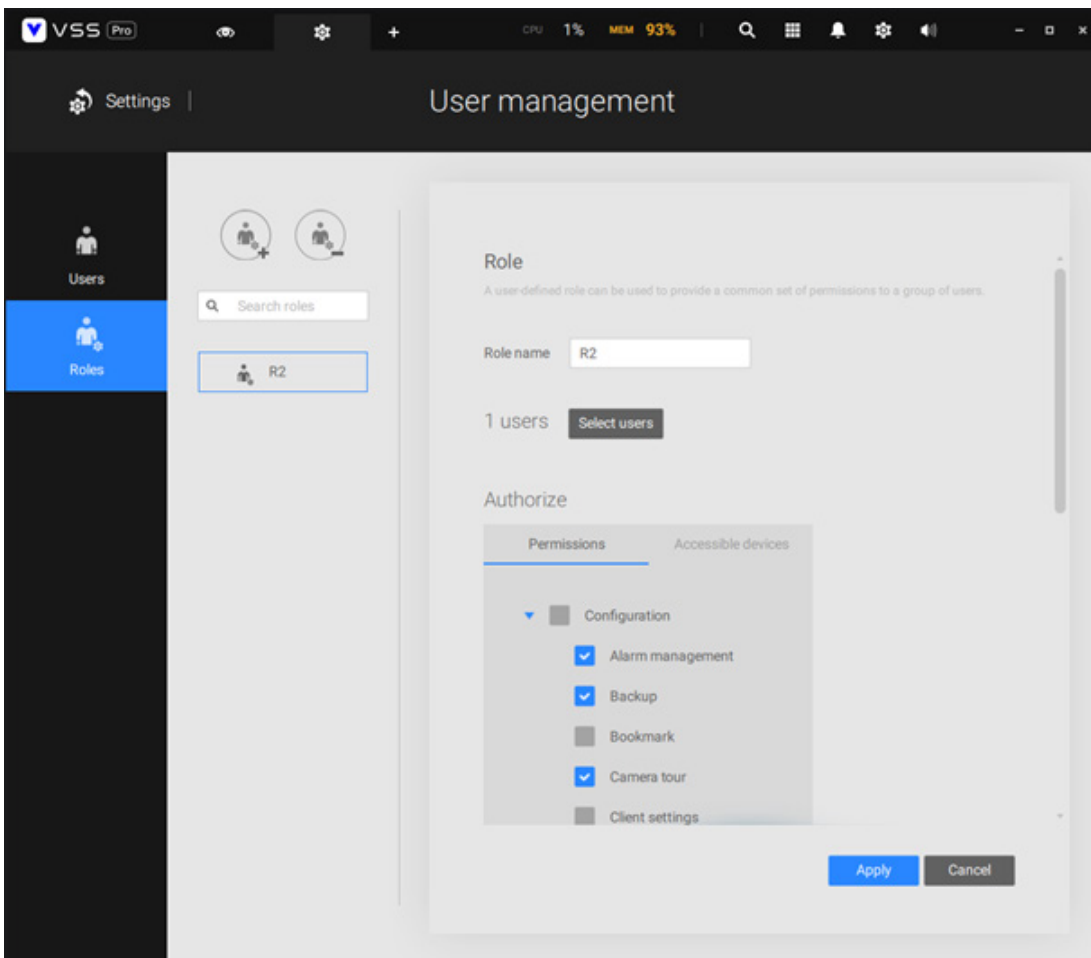
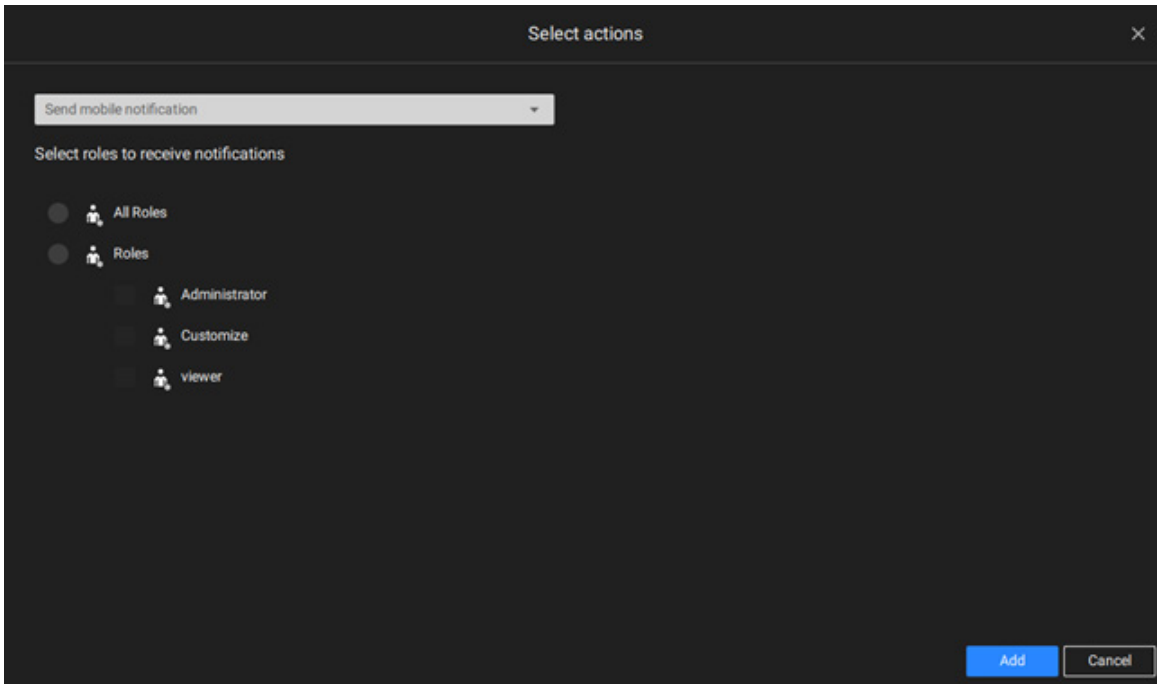

In addition, the administrator can click Settings > Device > External devices > Mobile device to query which mobile devices are using iViewer to log in VSS and to turn on (default) or turn off sending the push notification to a user's mobile device (phone).

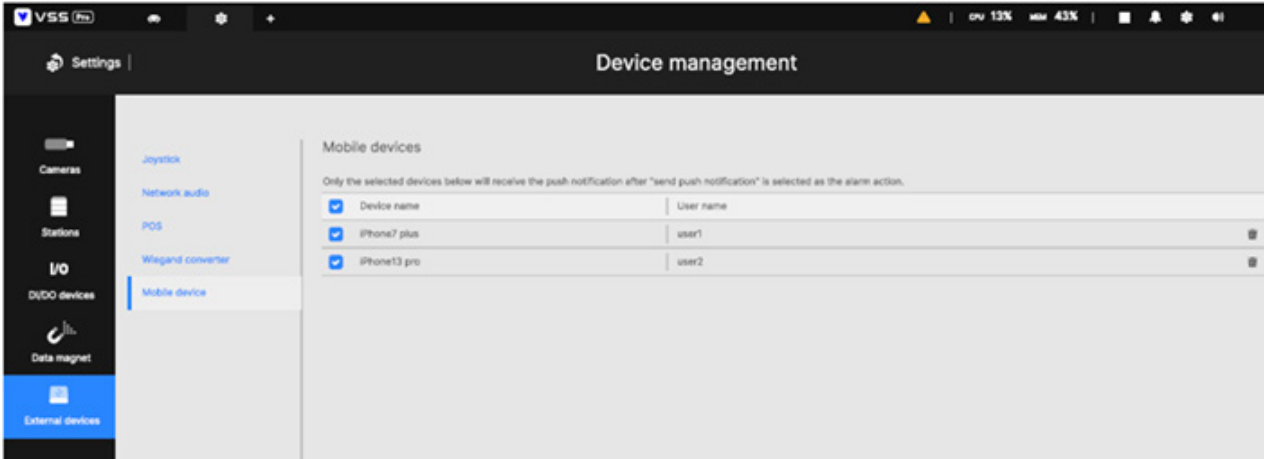

In other words, every user joining the VSS server can receive push alarm notifications by default. Once you remove a user from the notification list here, if this user logs in to VSS again, the user can still get alarm notifications. Therefore, if you must remove the user from the notification list permanently, change the user's password or delete the user account directly.



On the Schedule page, you can select to activate or de-activate alarm triggers throughout a specific timeline. For example, in some situations you can disable the alarm triggers during the office hours, and choose to enable the triggers only during the off-office hours.

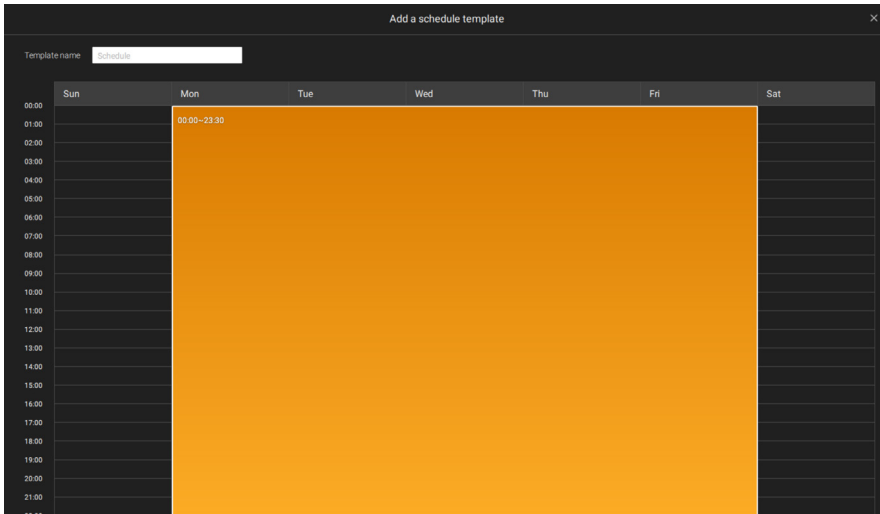

Click on any of the options on the Schedule panel for the alarm to take effect: Customize, Always, or Add a schedule.

You can manually create a effective time template using the New template button.

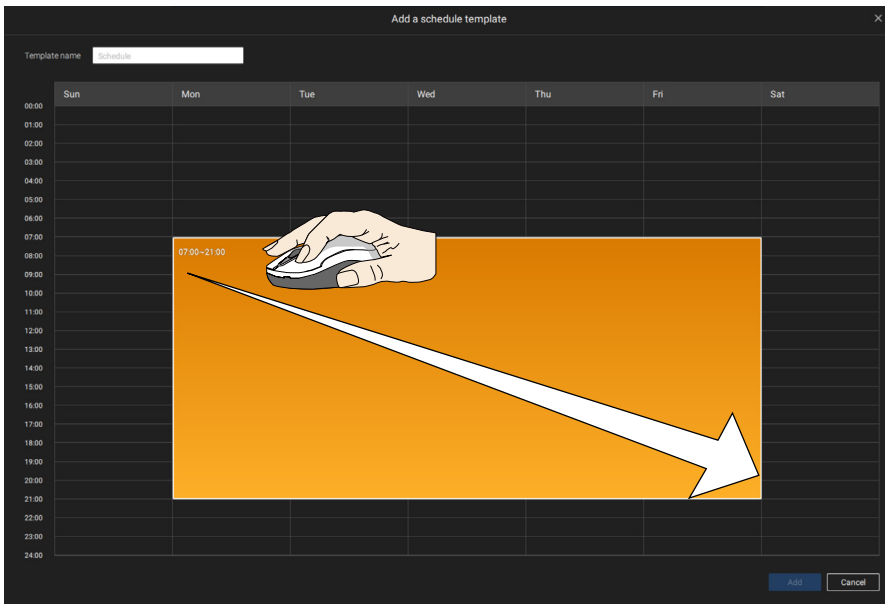

Click and hold down on the time cells, and drag the mouse to include the time span of your preference. The minimum selectable unit is half an hour. You can select multiple time spans on the template. Enter a name for the template, and click Add to save your template.

The same configuration window apply to both the Schedule template and the customize schedule windows.

Make sure a Schedule mode is selected when you leave this configuration step.

Enter a name and instructions for users to follow, and then click Add to complete the Alarm setting.

All configured alarms will be listed on the Alarm settings page.

Group Alarm

Multiple triggered alarms can be presented as group alarms. Alarms triggered by the same event type, and by the same camera can be grouped together. In this way, multiple similar alarms can be listed under one entry.

On the alarm list, click the  button to display the alarm group.

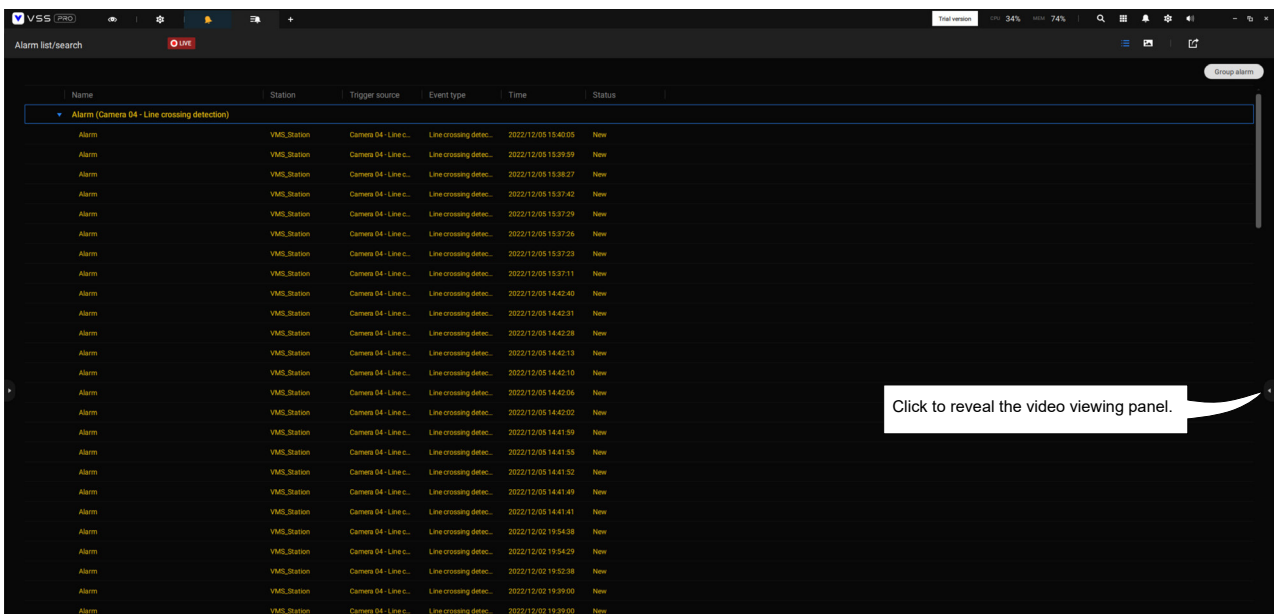

In the list mode, you can expand the right-hand-side panel. The video of the latest alarm will display.



When the alarm-triggered action is configured as sounded alarm, you can mute all alarms in the group by clicking the alarm sound icon.

Name	Station	Trigger source
▶ Alarm (FE9181-H - Motion detection) •		
🔔 ▼ Alarm (FE9181-H - Motion detection) •		
🔔 Alarm	VMS_Station	FE9181-H - Windo...
Alarm	VMS_Station	FE9181-H - Windo...
Alarm	VMS_Station	FE9181-H - Windo...
Alarm	VMS_Station	FE9181-H - Windo...

The same applies to the thumbnail view. To leave the group alarm view, click the Group alarm button again.

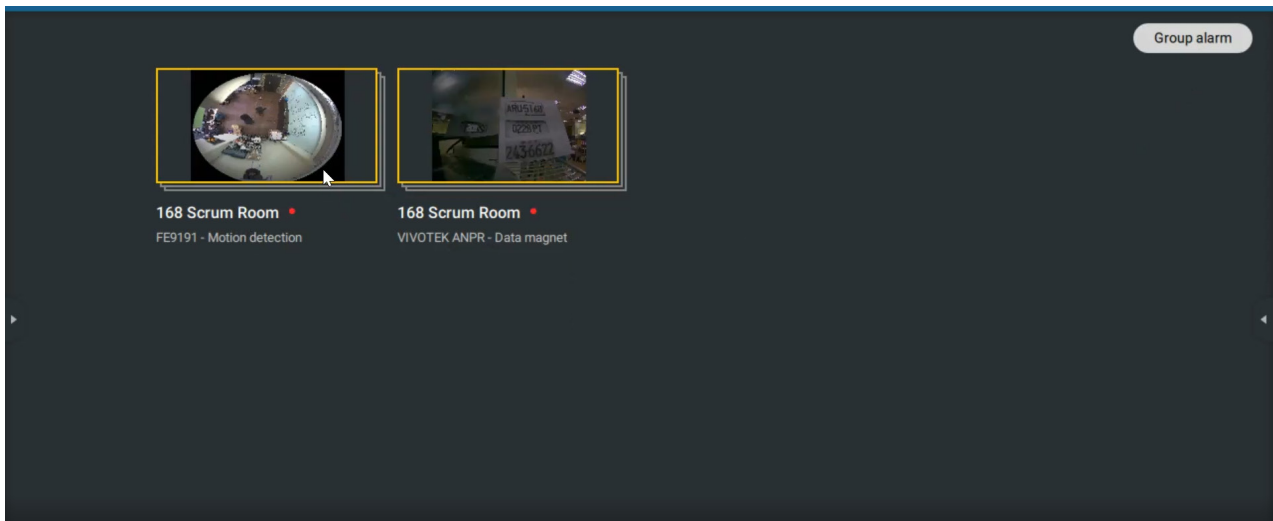

When the alarm action is set to "Send live streaming," the videos coming from the same camera will occupy only one view cell.

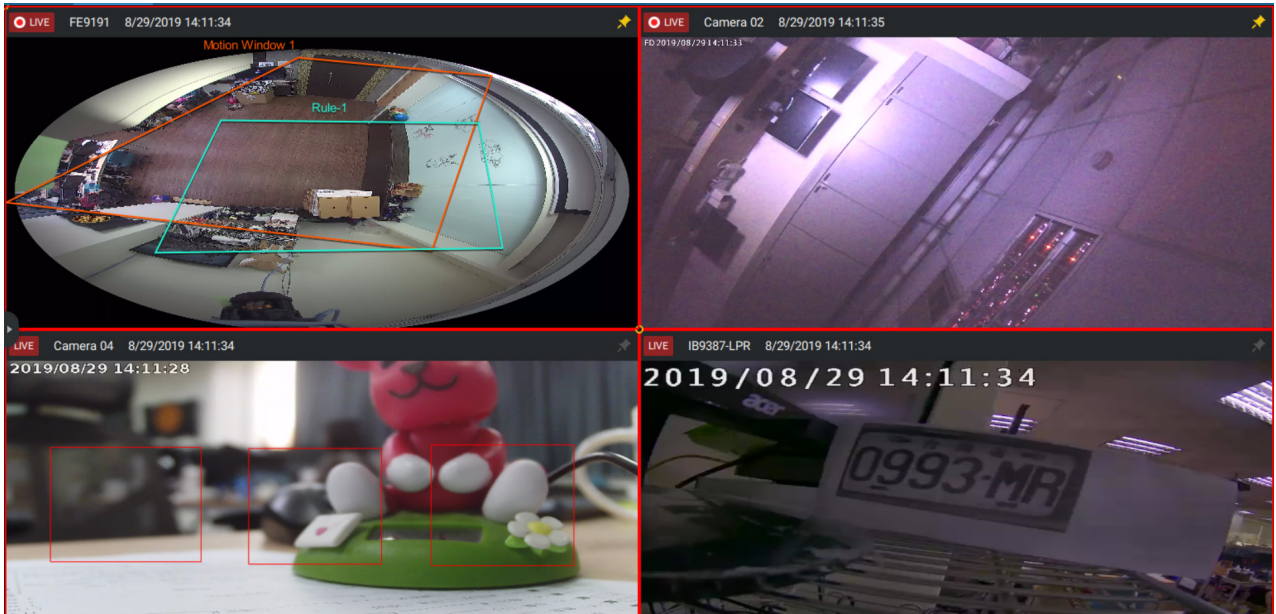

In the Alarm tab window, use the thumbtack  button to freeze the current screen. If thumbtacked, the other incoming alarms will not affect the current screen.

On arrival, the latest alarm will display with a blinking red frame. A selected view cell will display with a yellow frame.



Configuring Send HTTP requests

When configured, the server will send an HTTP request protocol to a 3rd-party device or application. The HTTP request supports GET and POST commands.

The GET method is to request data from a specified resource.

The POST method is used to send data to a server to create or update a resource.

Below is a screen for setting the GET command. Enter the target resource's URL address.

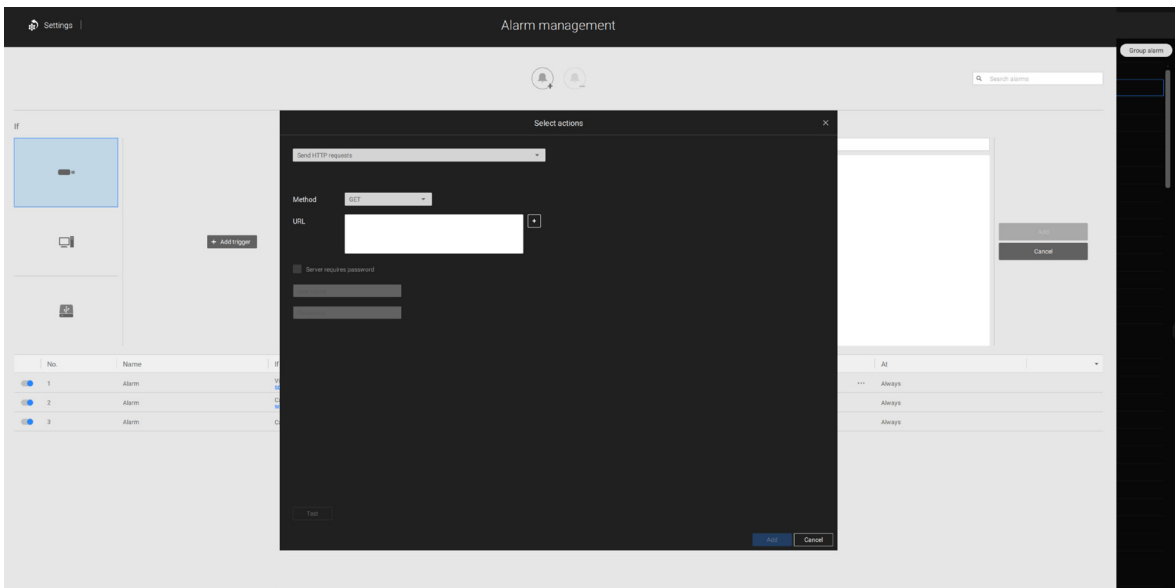

Below is a screen for setting the POST command. Enter the target resource's URL address, the content, and select the content type. If the need should arise for more content types, you can contact VIVOTEK's technical support.

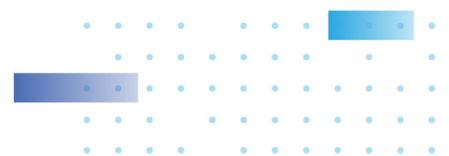
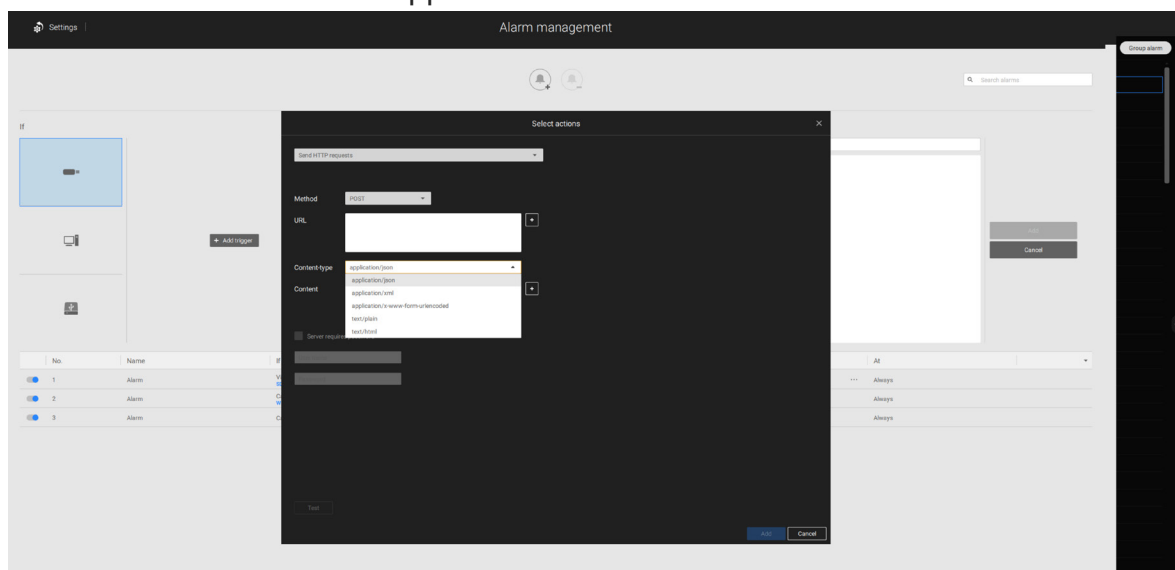

2-14. E-Map

To create your E-Map, click Settings . Click Import & Setup. Click E-Map.

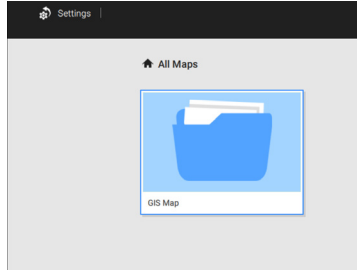
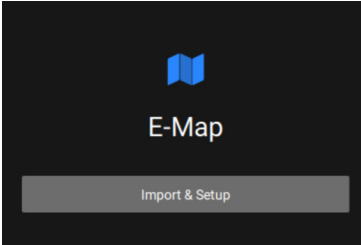

Click Import file  or Import folder . An entire folder can be imported.

When done, double-click on the snapshot of E-Map image to configure the E-Map.

Your cameras will be listed on the left. Drag and drop the cameras to the corresponding locations on the map.

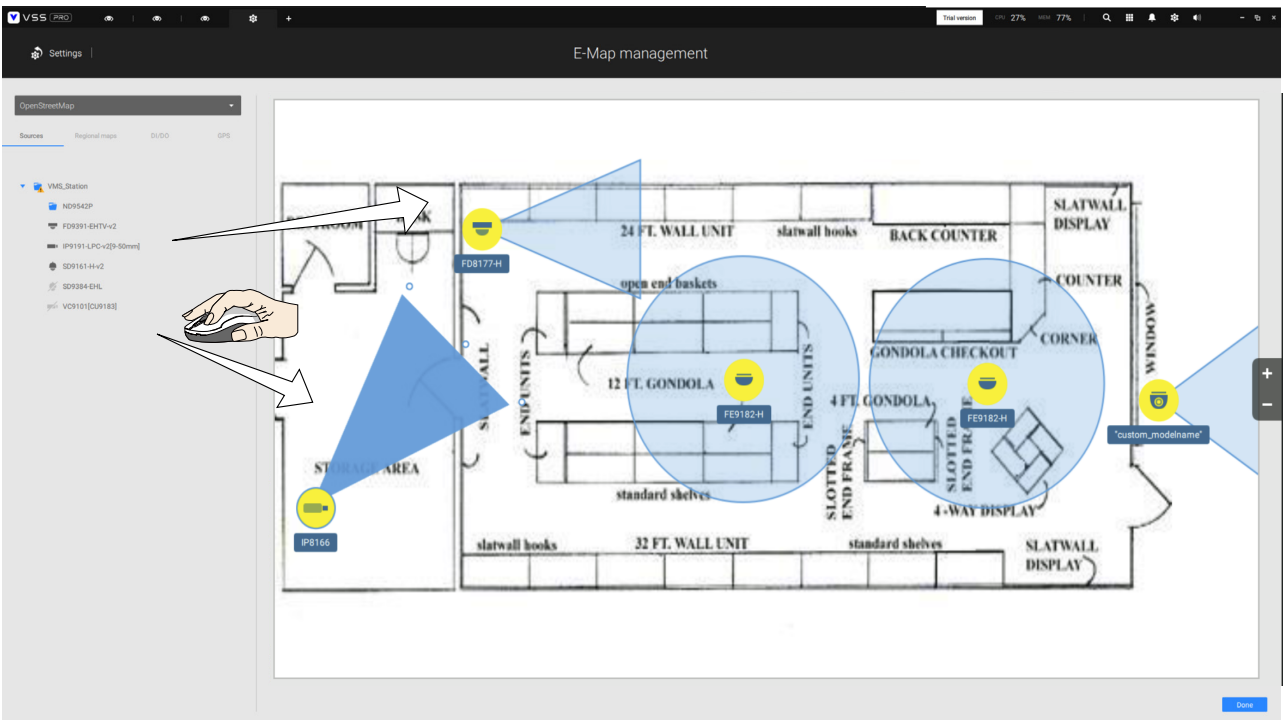

When the camera is in place, drag the FOV indicators on the edge to change the shooting angle and the coverage range.

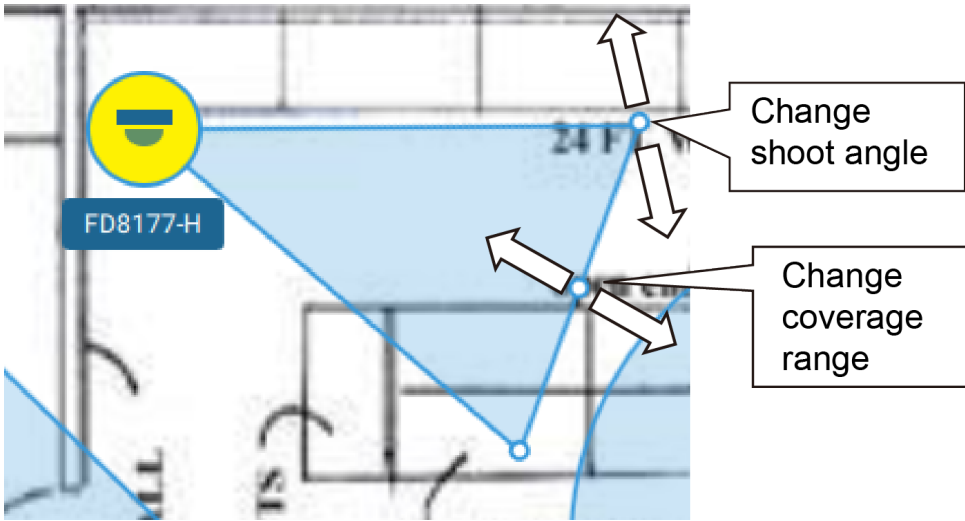

Drag the FOV to change the shooting direction to match the actual installation.

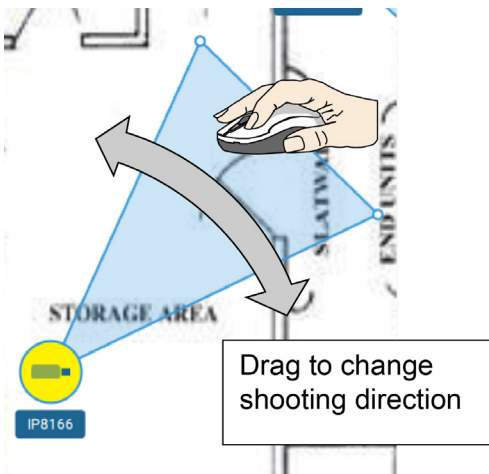

Click on the camera icon. You can also change the color of camera icon and the FOV type. Fisheye cameras, when ceiling mounted, have a round shape coverage.

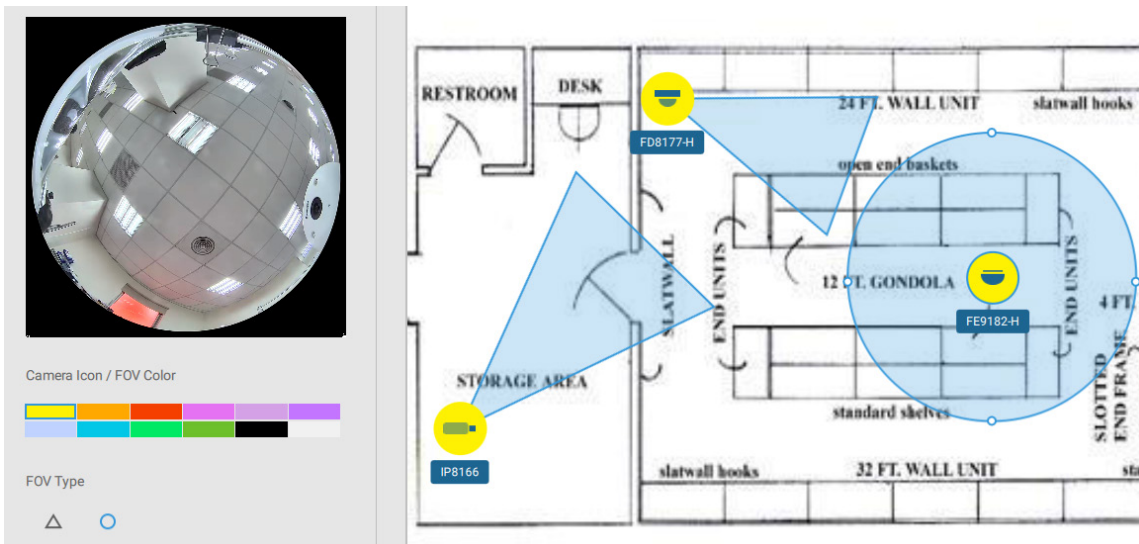

If you have a larger regional map that covers a geographical area, say, a street block, you can drag one or many E-Maps into it. For example, you can place another E-Map that is used to indicate the camera deployment inside a building that is located on the street.

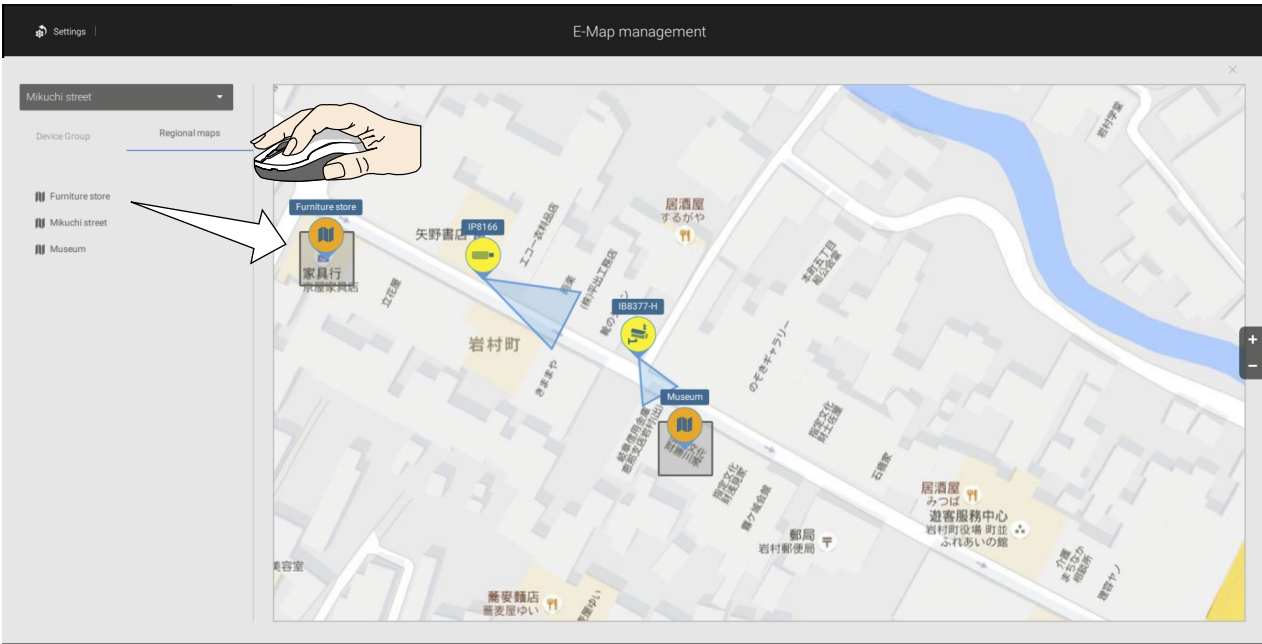

To see live streams from cameras, click on the camera icons in the E-Map.

When configuring an E-Map, you can use the tilt bar on the right to tilt the E-Map image. Doing so creates a sense of distance and depth of view.

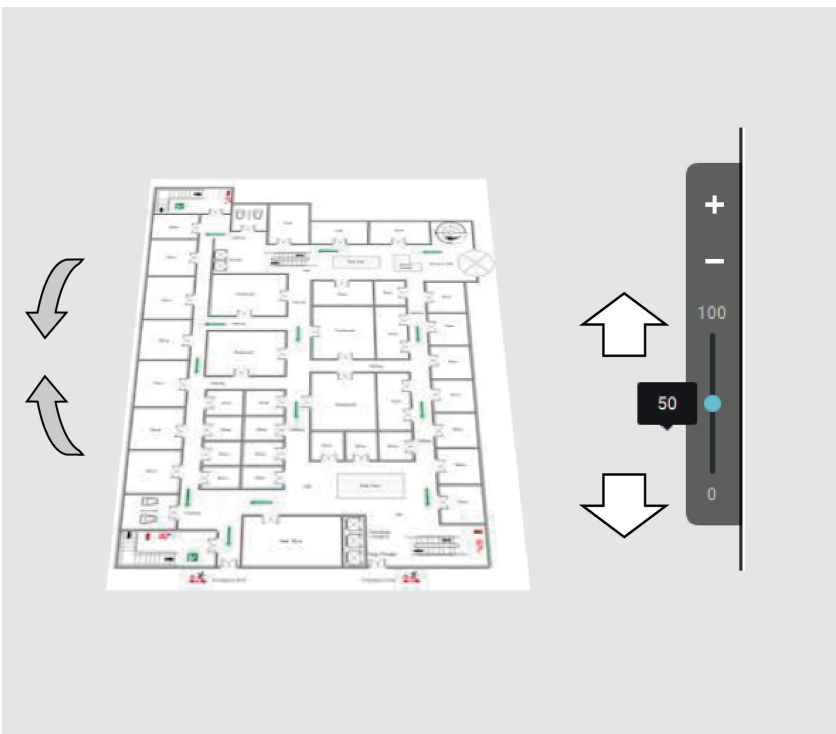

Placing DI/DO Devices

I/O devices can also be planted into an Emap, such as alarm or various kinds of detectors. The I/O boxes (such as Advantech's Adam series) or the DI/DO connections on an NVR also apply.

1. Select a floor map from the pull-down menu.
2. Unfold the sub-trees beneath the network camera (taking camera DI/DO devices as an example).
3. Select a DI/DO device. Click and drag to a preferred location on map.

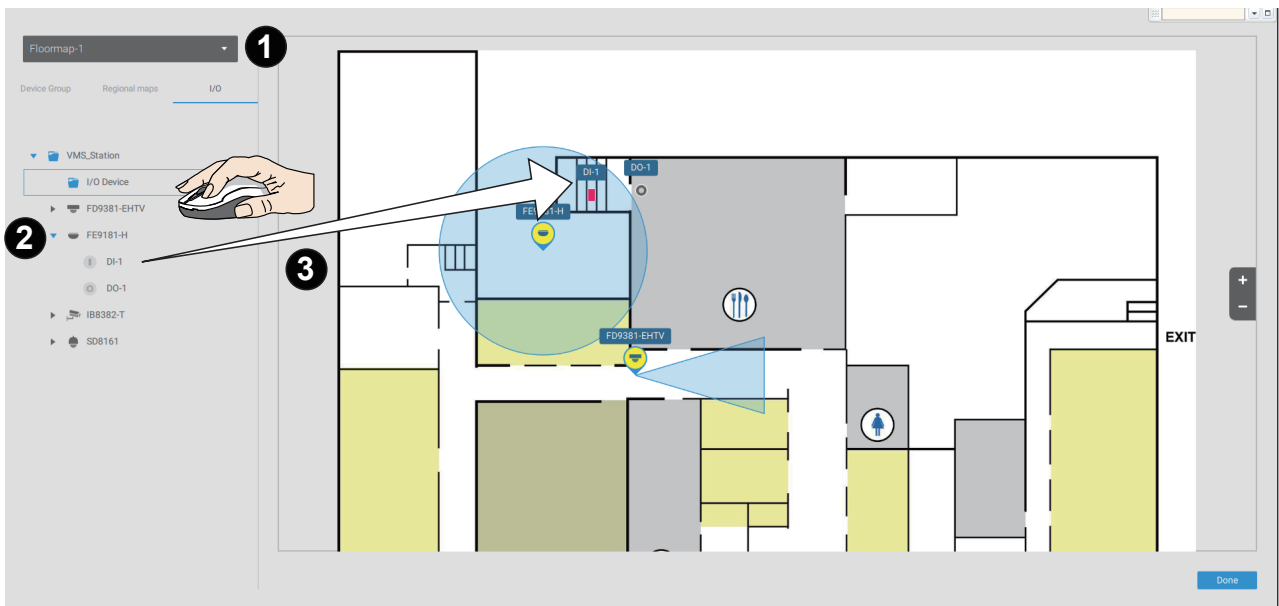

4. When a DI/DO device is selected, you can select the display colors of its icons. Configure different colors for the device status when it is normal or triggered.

5. When done with placing all DI/DO devices, click the Done button on the lower right of the configuration screen.

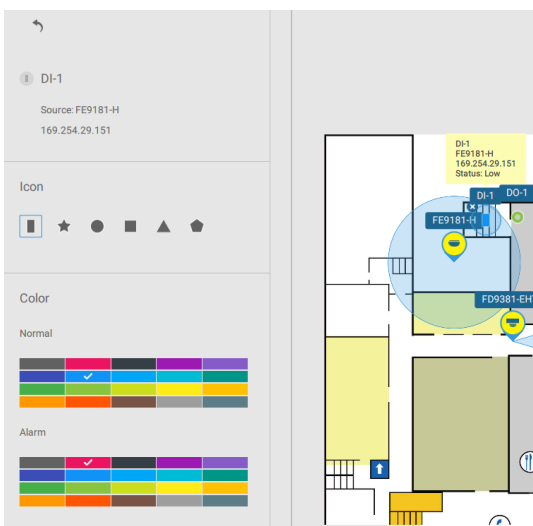

Uploading Substation E-map to CMS

This feature allows users to manually transfer E-Maps created on substations to CMS, saving time on redundant E-Map creation. Here are the operational steps:

1. Navigate to Settings -> E-Map.
2. Select "Add Substation E-Map."
3. Choose the specific substation E-Map you want to upload.
4. Once uploaded, the Substation E-Map becomes accessible in the E-Map function.

Notes:

1. Uploaded substation E-Maps do not automatically sync. If there are updates in the substation E-Map, a re-upload is required from CMS.
2. Editing the content of substation E-Maps is not allowed on CMS. Updates must be made on the substation itself, followed by a re-upload to CMS.

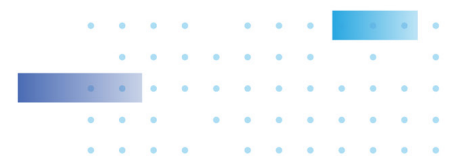
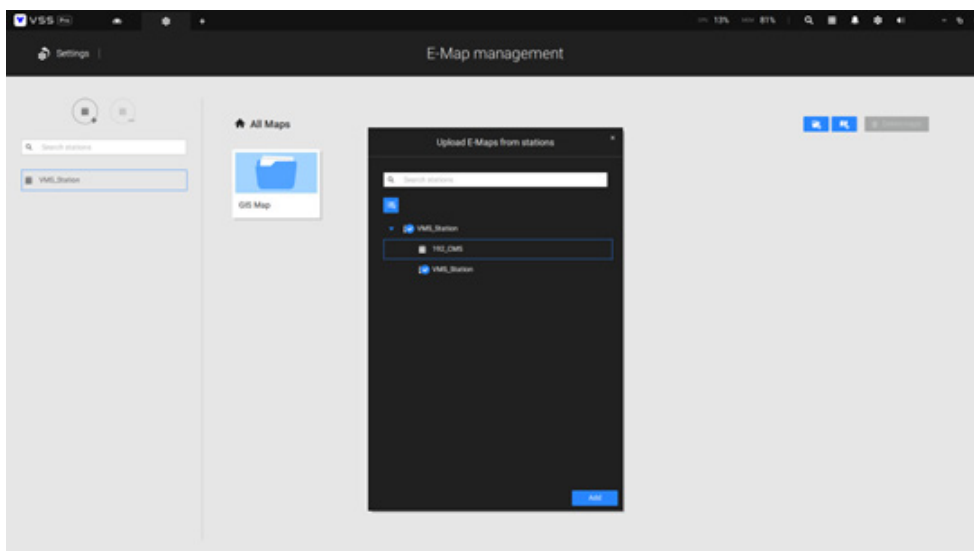
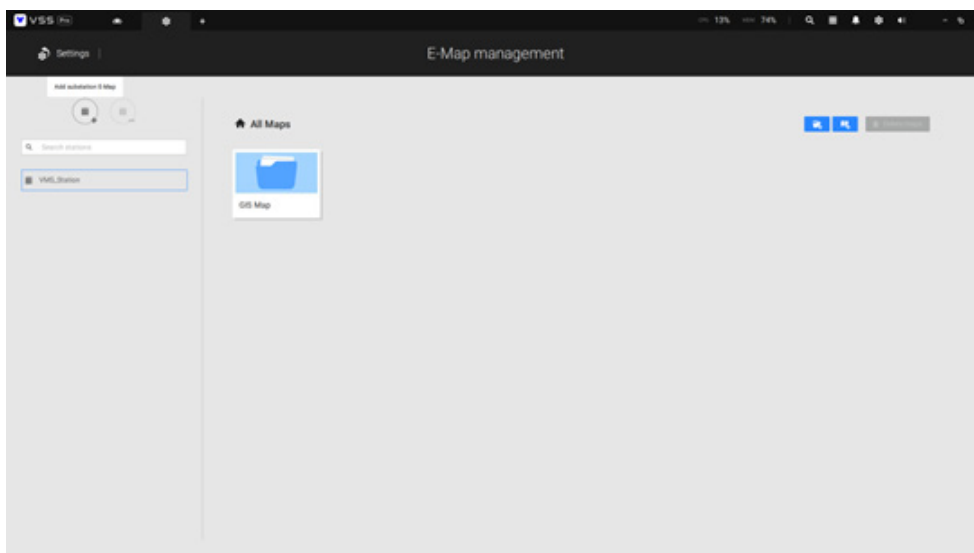

Configuring GIS or Google Map and GPS

Since Google Map changed its access policy, using the Google Maps feature requires user entering a billing API key. Using Maps, Routes, and Places APIs requires an API key.

For applying a Google API key, <https://cloud.google.com/maps-platform/maps/>

Visit [Settings > Emap > All Maps](#).

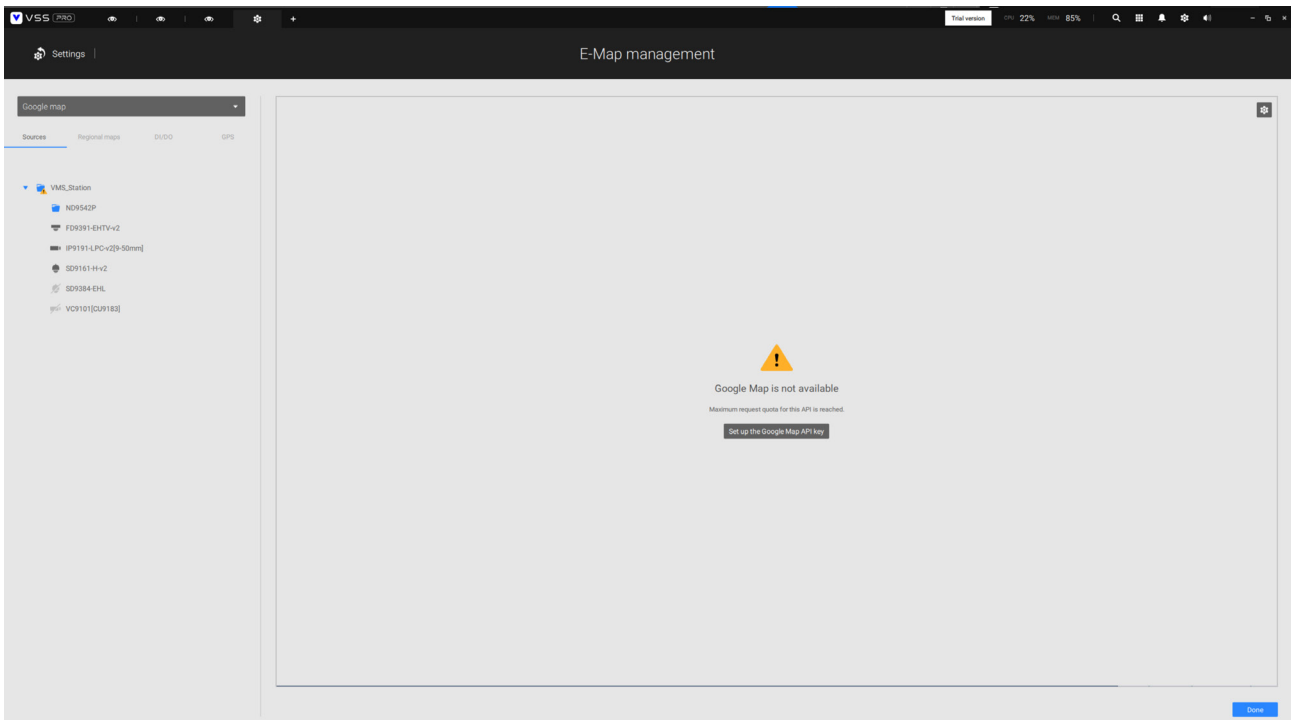

Enter the Google API key you previously registered (if using Google Map).

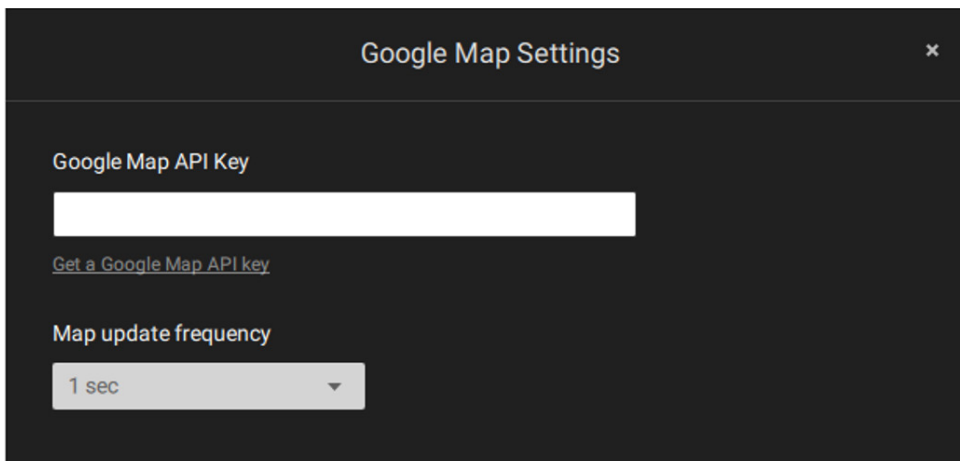

NOTE: In this revision, Google Map only supports installation on a GPS-enabled vehicles. Placing cameras on a static location on Google Map is currently not supported.

Before configuration on a Google Map, you should prepare an E-map drawing for special installations, such as that on a vehicle. The vehicle, e.g., a train, should come with a GPS-GSM/GPRS module to collect the position information and pass this information to a web-server. As new data is constantly inserted to the database, the VSS server will update the location information containing coordinates, speed, distance, time, etc.; and when video recording is required, the location information and time tags will be available.

This applies to a mobile NVR that comes with GPS functionality.

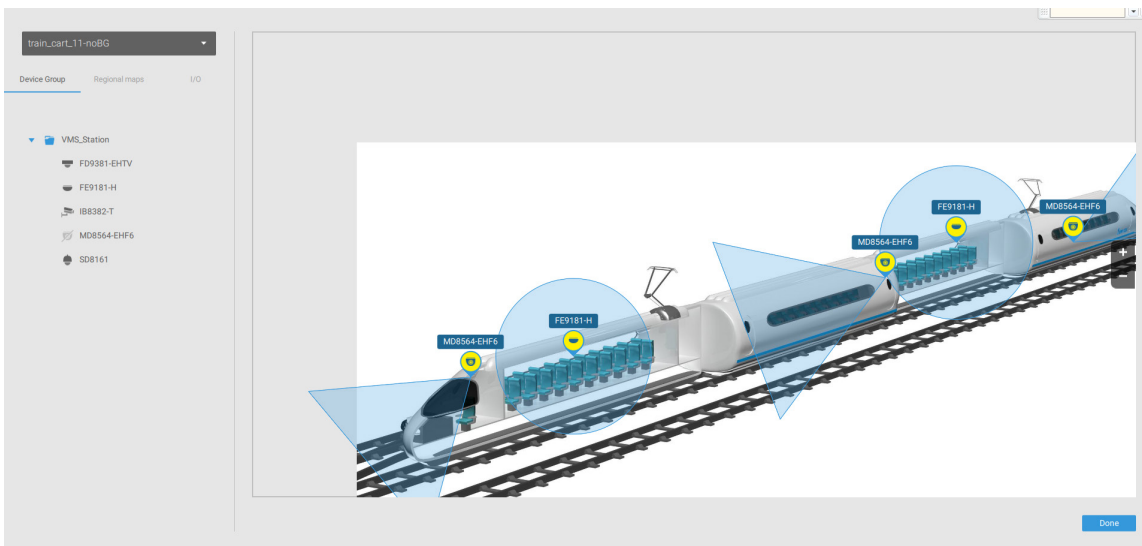

Open the E-Map Import & Setup window.

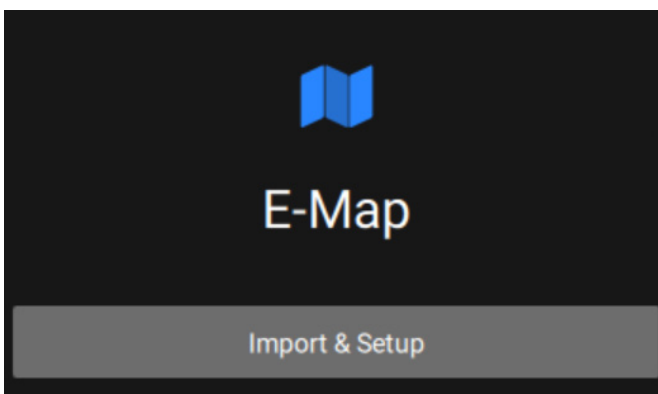

Click to enter the GIS (Geographic Information System) Map and then Google Map window.

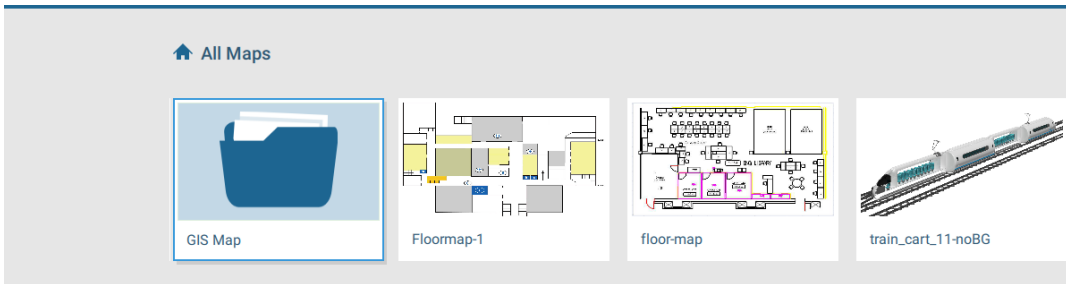

Click on either the Google map or the OpenStreetMap.

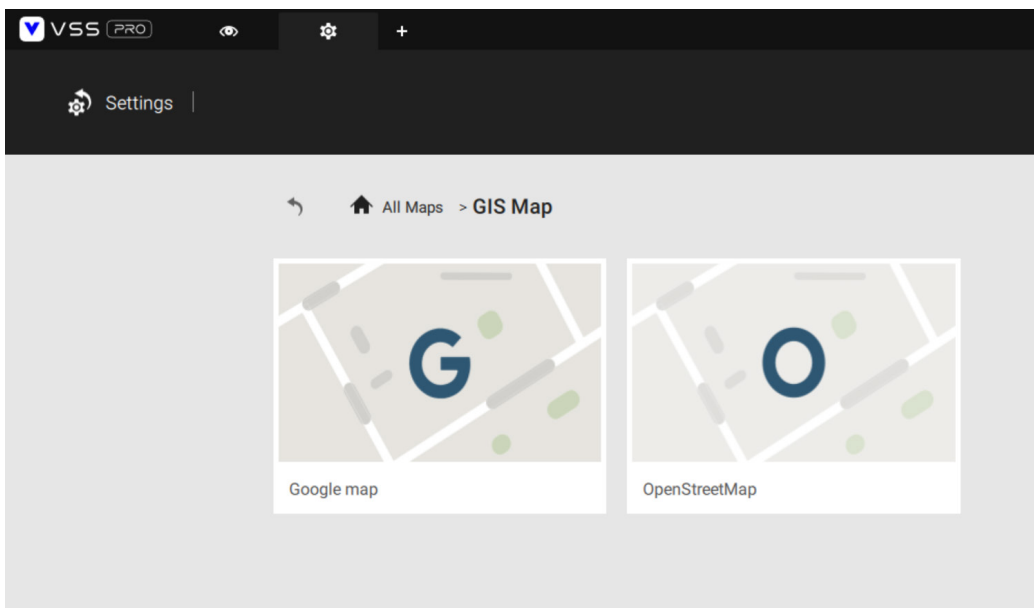

Click on the GPS tab. Select a VMS station or mobile NVR to apply the configuration, and then select the GPS Add button.

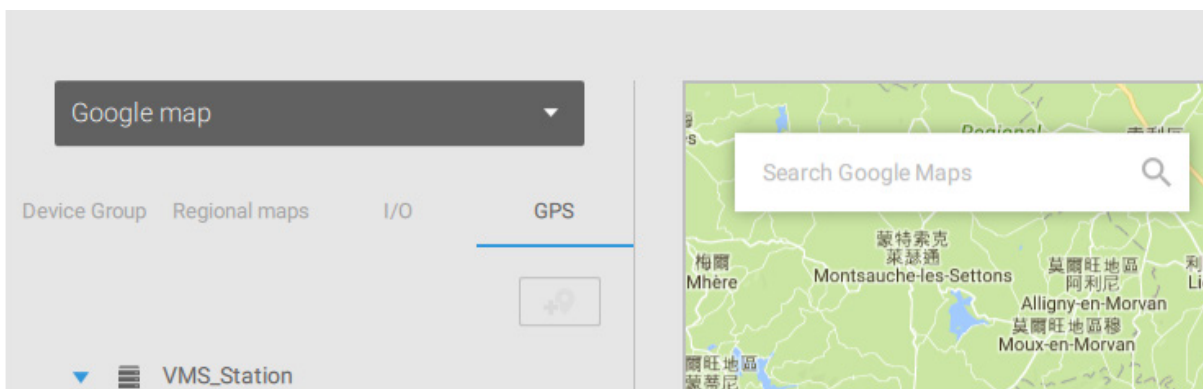

Enter a name for the GPS/GNSS server on the vehicle, its IP address, and server port number. You can select an E-map that will display when you click on the GPS location icon. Select the checkbox and an E-Map that corresponds to the deployment on the vehicle. When done, click the Apply button.

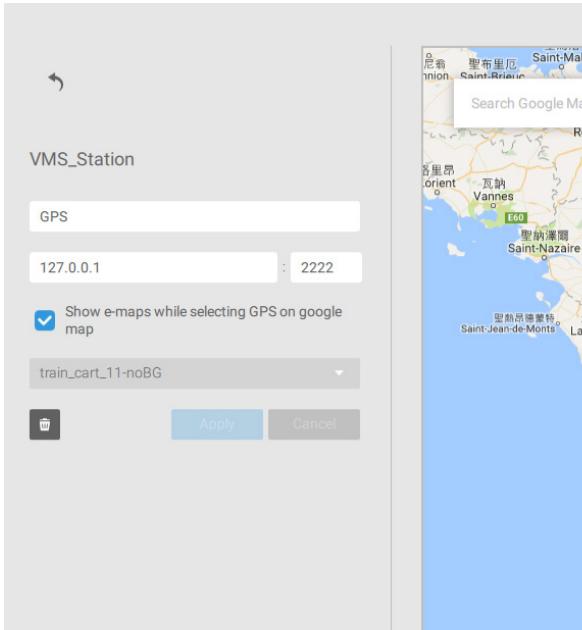

You can skip this setting for the mobile NVR that comes with a built-in GPS module.



You can click on the location icon  to bring up the E-Map. The coordinates, speed, and time information also display on the map.

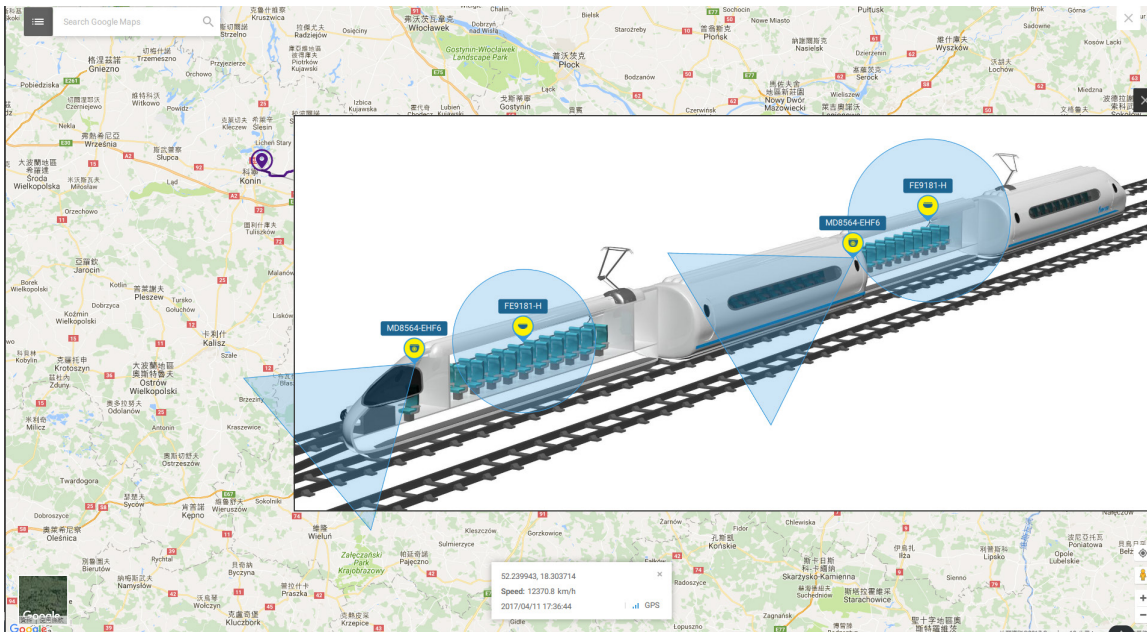

You can click on any cameras on the E-map to search through past recordings. One click displays the live view. A live stream window will display.

To search and review recordings when an event occurs,

1. Click on the Playback button.
2. Click the Pane button to display the Playback control panel.
3. To search for the video of past events, pull the Playhead to a point in time on the timeline.
4. The GPS coordinates and time will change to those corresponding to the time you selected. You can then acquire the corresponding location information while tracing the occurrence of an event.

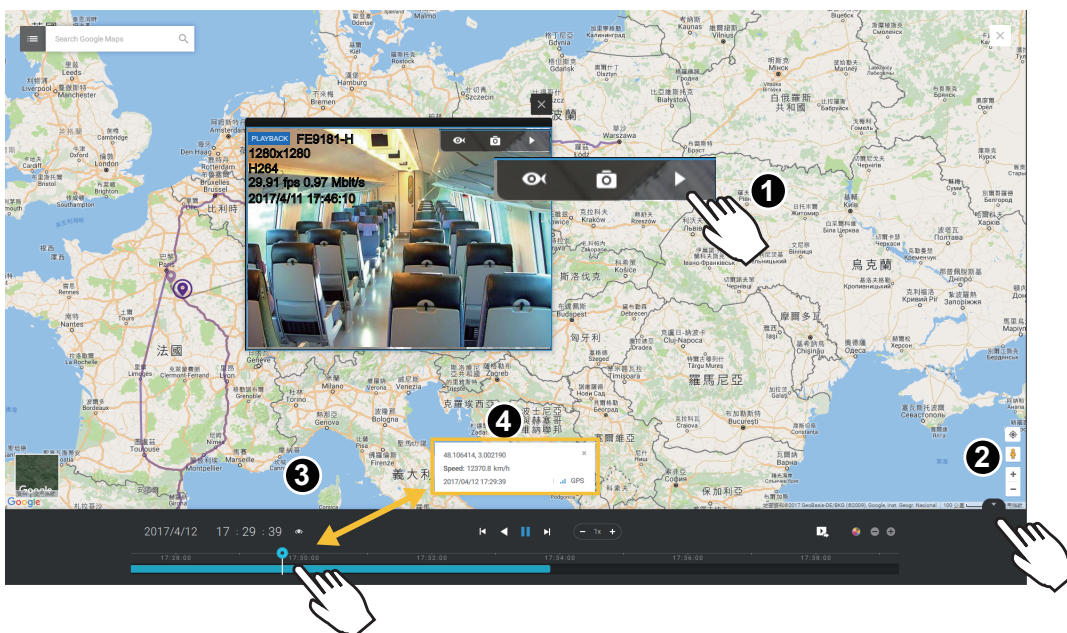

Click on the Setting button  on the map to bring up the Map update frequency option. Your GPS target may travel to the outside of the map through time without the map being updated. The map will update by the interval you configure here.

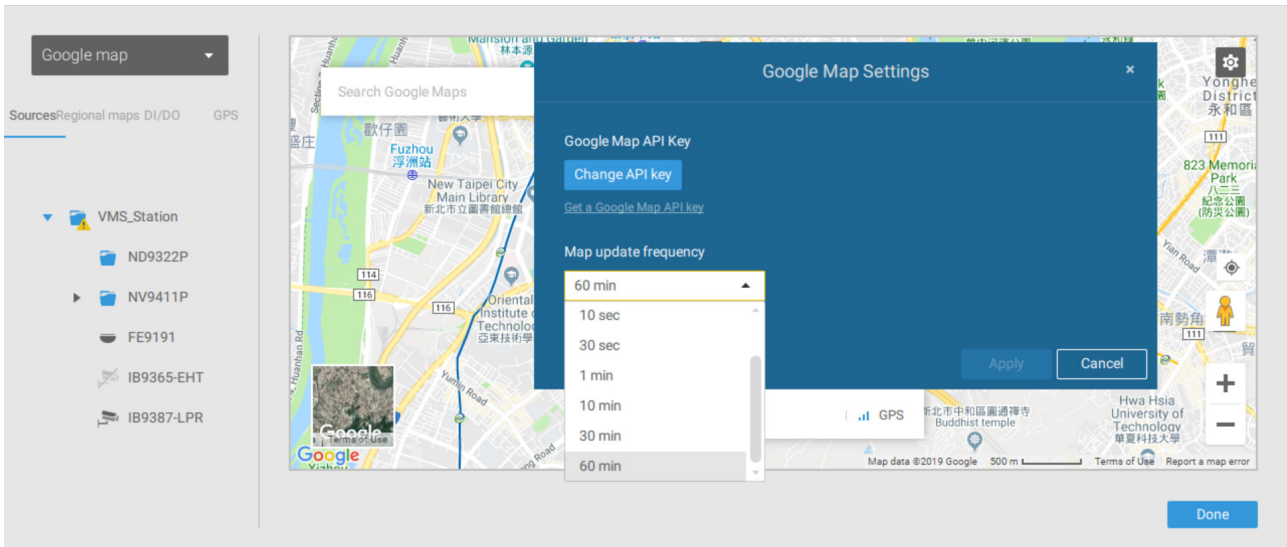

2-15. Dashboard

Select to open the Dashboard utility from the tool bar. The Dashboard displays the system resources of a CMS server along with those of its sub-stations. This provides a glimpse of the load on machines when performing the recording and monitoring tasks.

Mouse over the edge of the bottom row to reveal the expansion mark. Pull the status row up to display the system resource statuses.

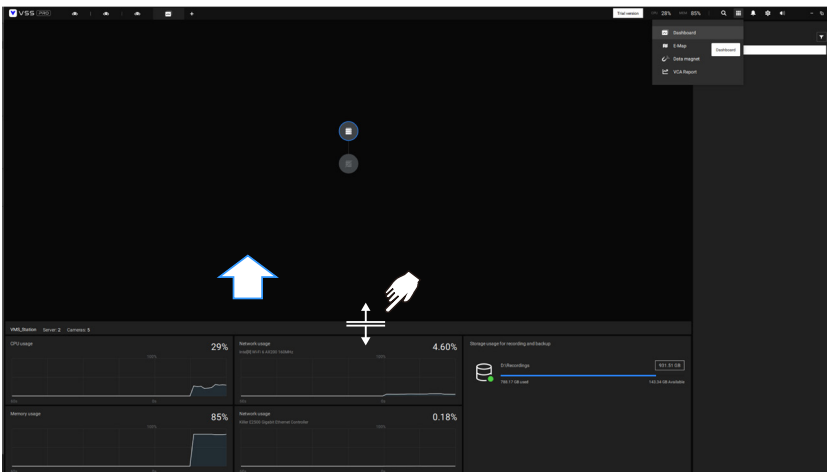

The possible system abnormalities can be:

- CPU utilization over 90%
- Memory usage over 90%
- Network usage over 90%
- Camera disconnected
- Station disconnected

If you have multiple LAN cards or virtual HBAs, the status row can be pulled to reveal all of their statuses.

The "Storage Usage for Recording and Backup" panel displays information for each recording group, showing the total recorded days and estimated remaining recording days based on current storage capacity. It also provides details about storage volumes, indicating their capacity and usage size.

Notifications appear on the dashboard's status panel if a storage volume goes down or disconnects or the sum of estimated remaining recording days and recorded days falls below the user-defined retention days in the Recycle Option.



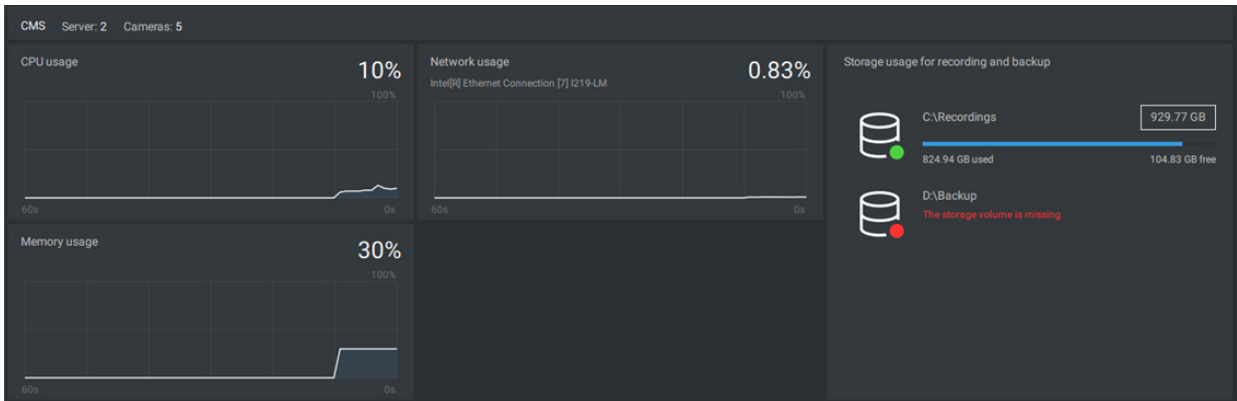
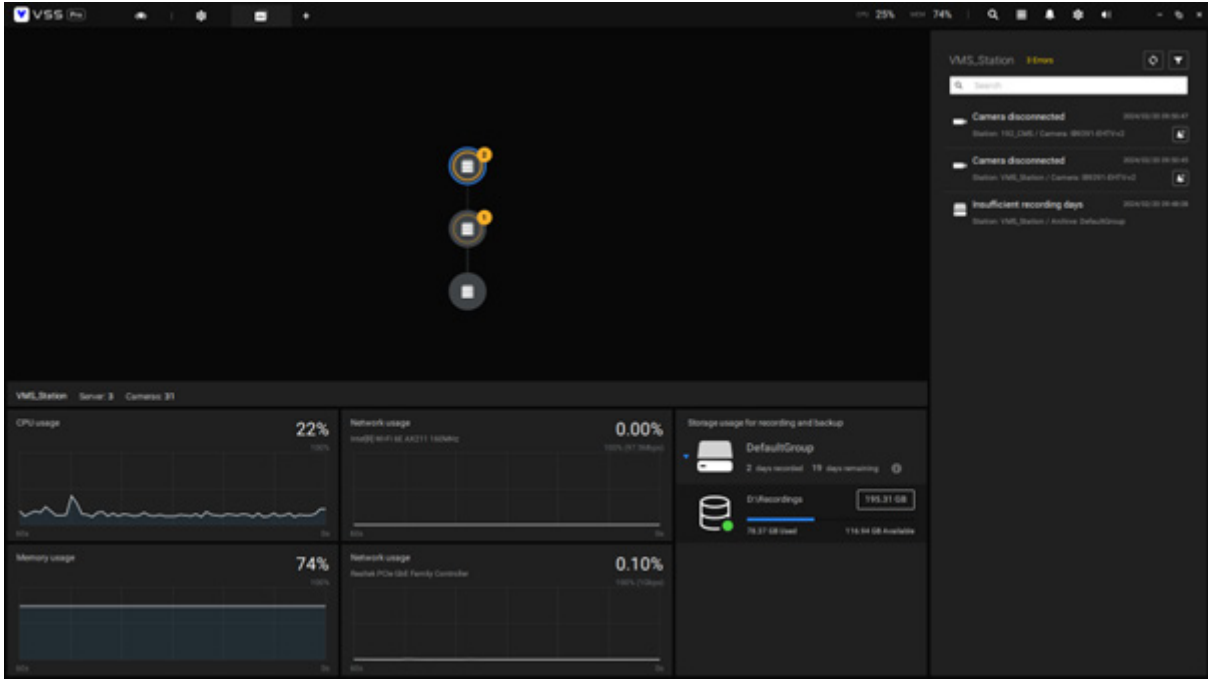

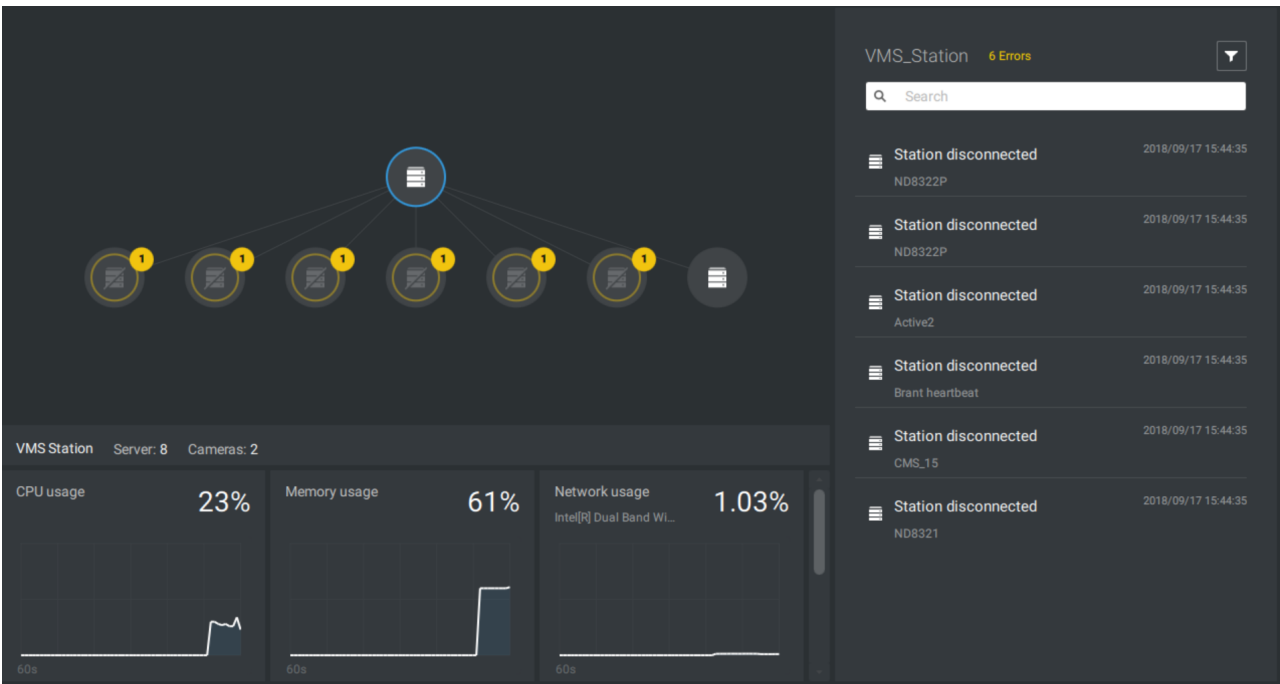

If you have multiple sub-stations, single-click to select and reveal their individual status, including CPU usage, memory usage, network usage, and storage usage.

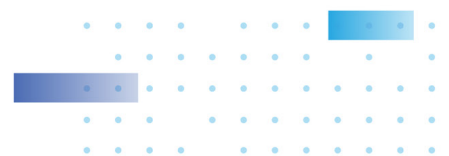
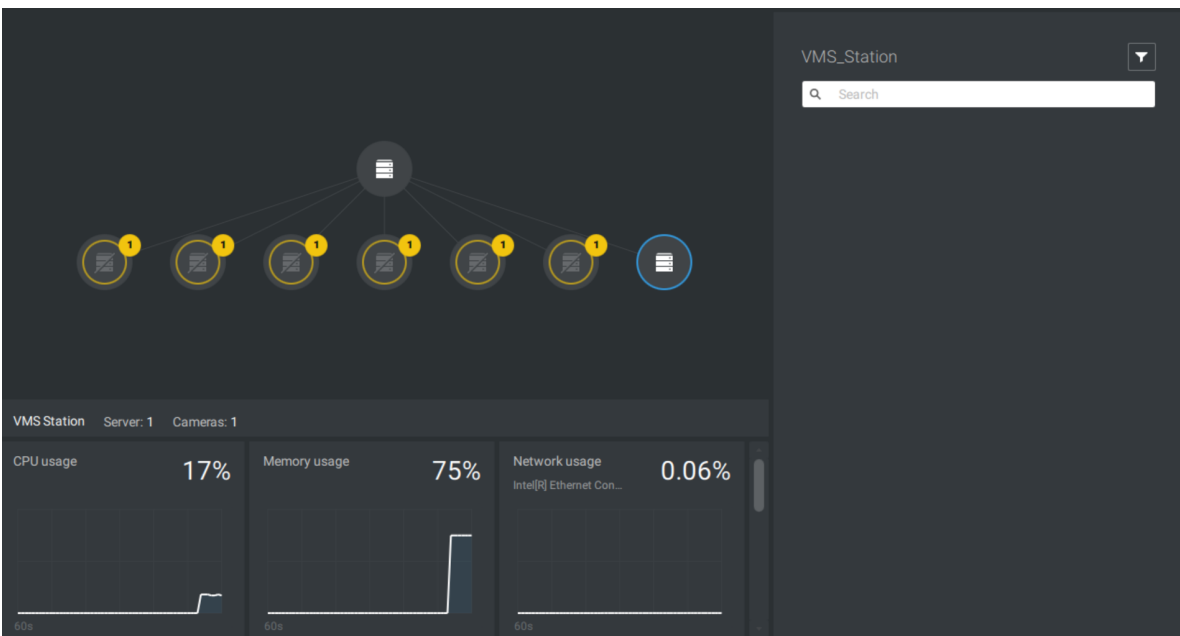

Note that VSS servers of the earlier revisions and NVRs running older firmware do not deliver their statuses to your Dashboard.



2-16. Search Panel

The Search panel is accessed via the Search  button. 4 key functions are provided:

Bookmark search, Deep search, Event search, and Smart search.

1. Search by Bookmark: Bookmarks are manually created when users review recorded videos in the Playback mode. Each bookmark comes as a 10-second video clip.

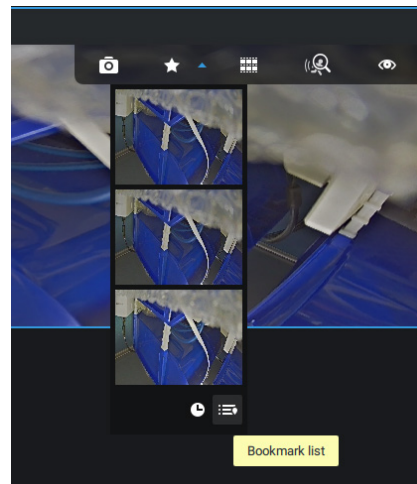
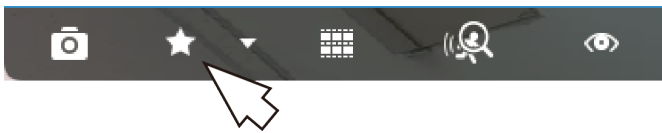

In the Bookmark search panel,

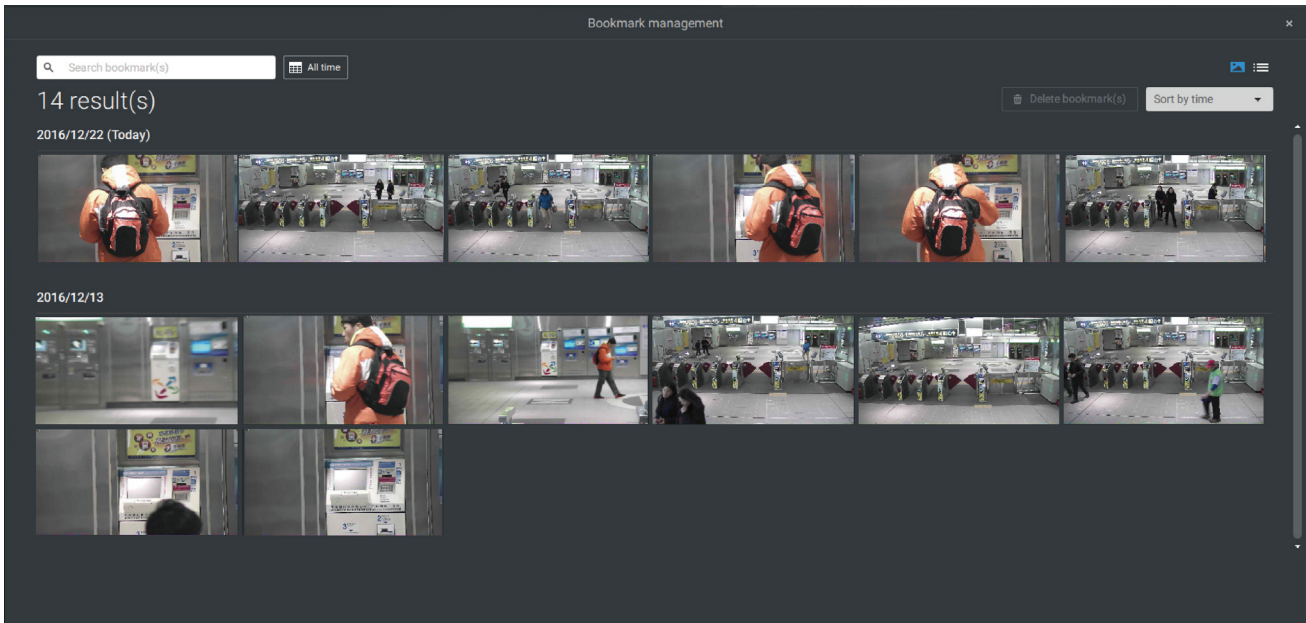

Click the Bookmark search  button. The Bookmark Management window will prompt. All existing bookmarks will be listed with thumbnails.

- a. On this window, you can specify a range of time during which the video streams were recorded and its points in time when bookmarked.
- b. You can then click on a bookmark to display the short video clip extracted from within the recorded video. The default is 10 seconds.
- c. To remove an existing bookmark, left-click to select an entry, and then click the Delete bookmark(s) button. Bookmarks will be indicated as "Invalid" if the videos where the bookmarks were appended were erased, e.g., when the original recording was erased by cyclic recording.
- d. Currently you can search for bookmarks using the name of the camera.
- e. You can also select the display types for the bookmark search in either the thumbnails or list mode.



2-17. Event Search

The Event Search window is accessed from the top tool bar.

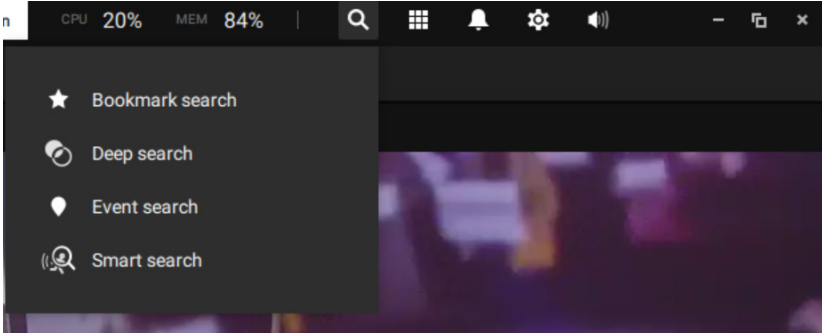

Below is the comparison between the Alarm list and the Event search windows:

Alarm List	Event Search
<p>Reports alarms triggered by user-configurable events, such as DI/DOs, Motion Detection, tampering, VCA analytics, cybersecurity, and so on.</p>	<p>The events on the Event Search window require no user configurations. The Event Search window displays system events and provides a glimpse of all general events.</p> <p>The event types include: General events, Video Content Analysis events, and Trend Micro IoT Security events.</p>

The sample screen for VCA-related events is shown below:

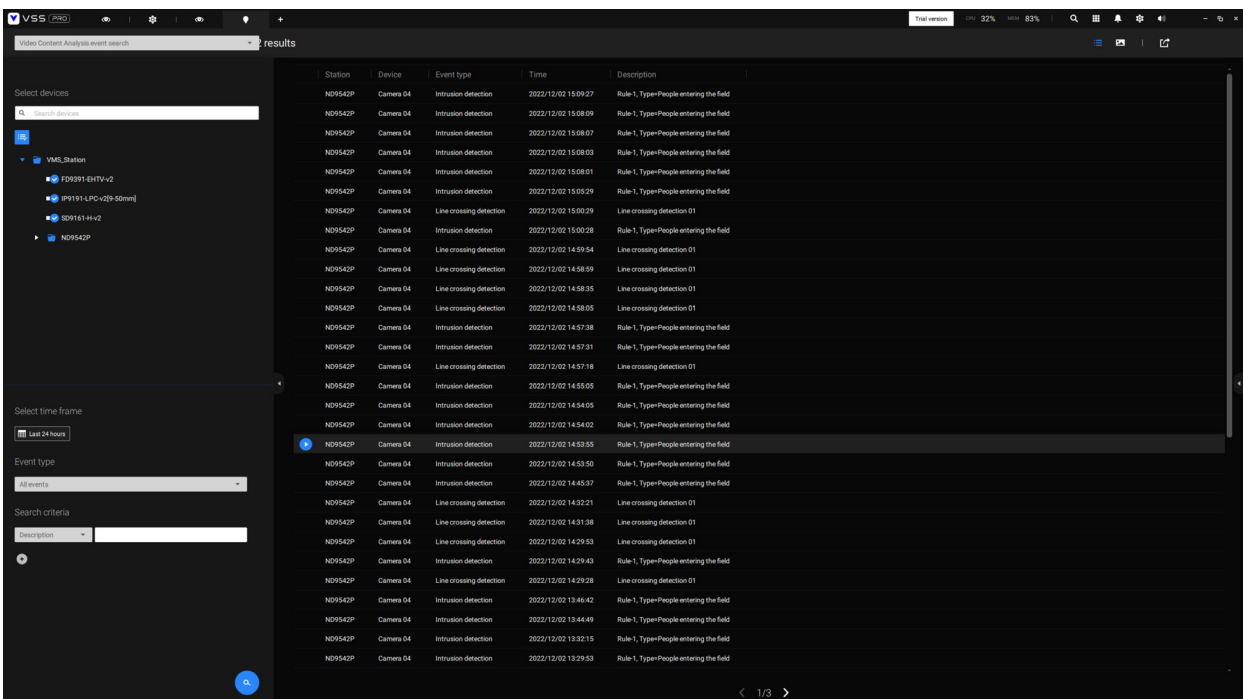

The sample screen for network security-related events is shown below:

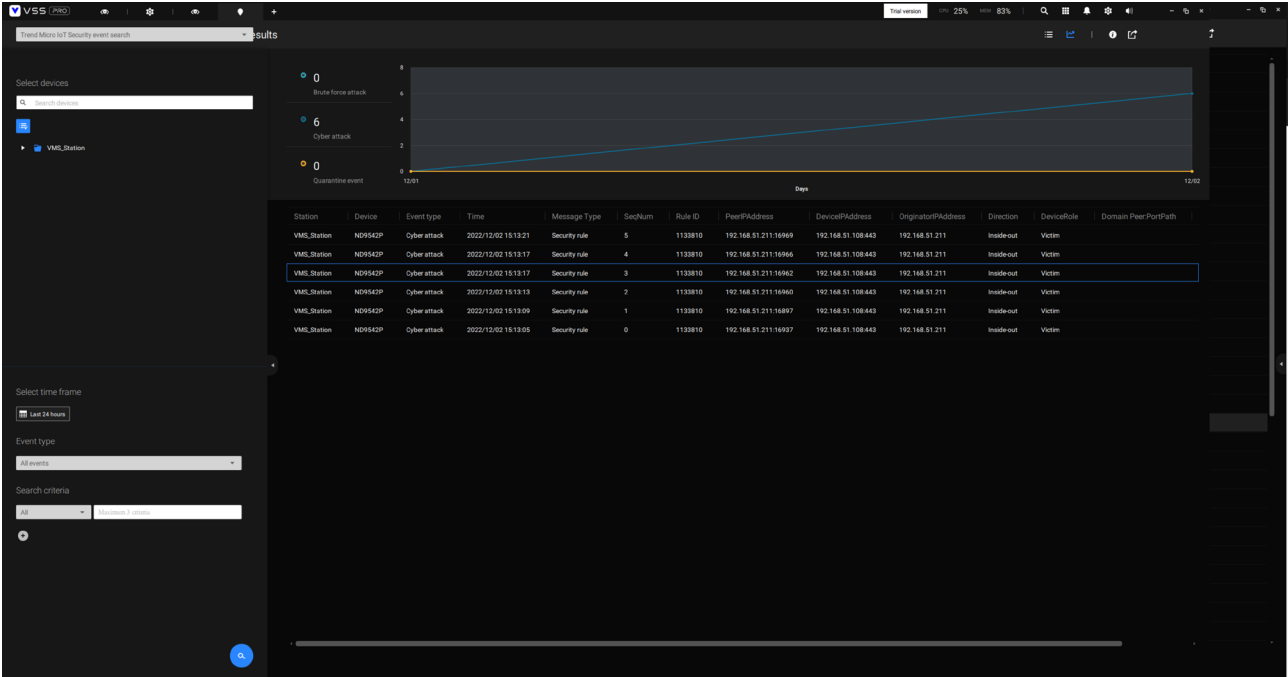

From the Search Event window, you can view and search events by its event types, and use the Export  button to save a record of these events (in the CSV format).

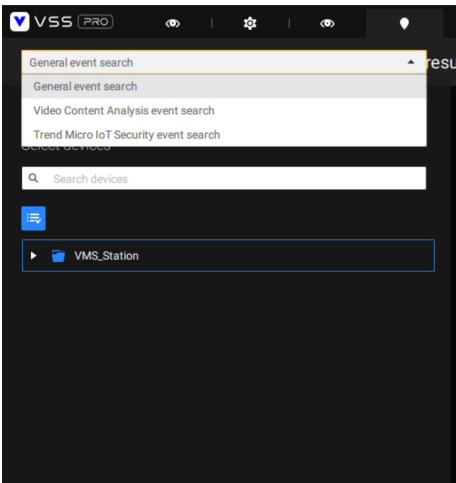

Use the calendar tool to specify the span of time as the search range.

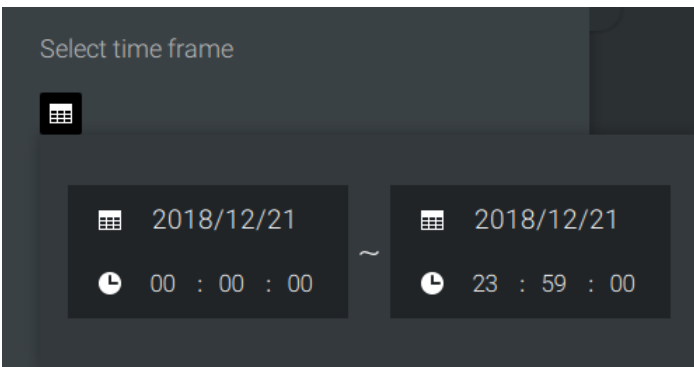

Use the Event type menu to narrow down the types of events. Select or deselect the event types for search. You may also enter one or several keywords as the search criteria in the following menus.

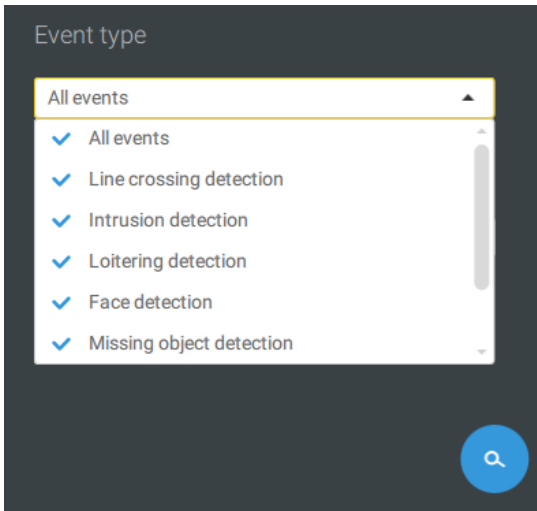

Click the search button to generate search results.



2-18. Thumbnail Search

The Thumbnail search function is like doing a post-production editing in film making. Screens from across different time spans are shown to facilitate the search for evidence.

VSS now supports the search for the instances stored on VIVOTEK's Linux-based NVRs.

Click on the Thumbnail search button  to enter the Thumbnail search window. The default time span is 100 minutes, starting an hour earlier of the current system time.

To use Thumbnail search,

1. Use the date and time selectors to specify a time span during which you suspect the event of your interest has occurred.
2. If preferred, tune the interval and clip size. The default length for each clip is 10 seconds.
3. If you find a clip might contain an event of your interest, you can click to select, and then slide left and right to watch the activities within.

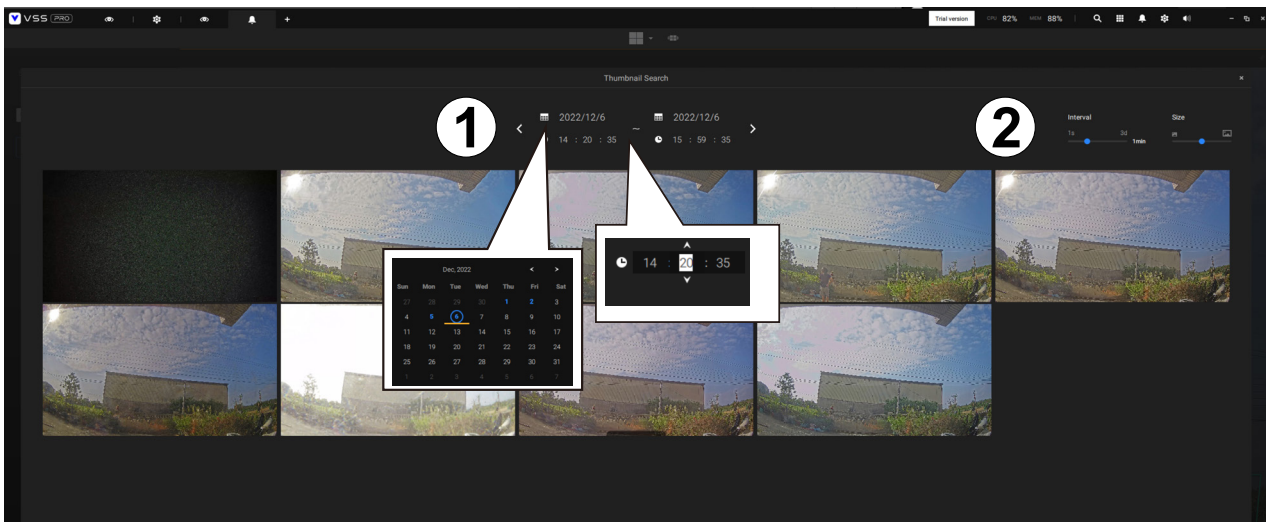

4. Hover your cursor to the lower center of a clip to display the Play and the More snapshots options. If you click More snapshots, another window will prompt to display all frames within the clip.

When you select to display the clip details (specific time span), the time span and the interval information will change accordingly.



When you find an event of your interest, you can play that video clip and use the export function on screen to output the evidence. You may also place a bookmark on the timeline.

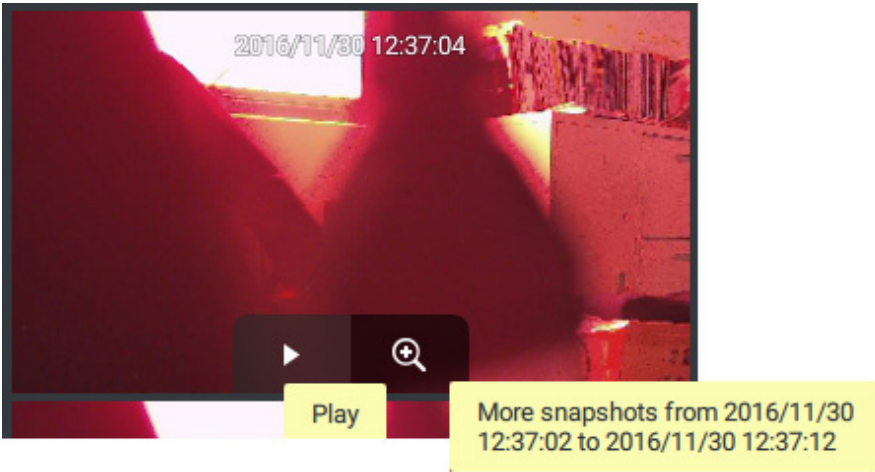

2-19. Smart Search

The Smart search function enables a quick glimpse of activities occurred within a user-configurable detection area from the recorded videos. Smart search is available in both the Liveview and Playback mode.

Click to select a camera view cell. Click on the [Smart search](#) button  to enter the Smart search window.

There are two Smart Search modes: Smart search II and Smart search I. The Smart search II applies to the recordings of the cameras that come with the [Smart Motion, and other VCA](#) capabilities. There are two kinds of metadata polled from camera VCA packages:

1. [Motion cell](#): Pixel-based information. The search results will include all moving objects in the scene.
2. [Object information](#): Human-based information. If People or Vehicle detection is selected, only objects detected as human or vehicle will be displayed as the search results.

Please refer to VIVOTEK's website pages that are related to the Smart motion and Smart VCA features for the supported cameras.

Note that not all cameras support the latest vehicle detection feature.



Below are short description for the Line Crossing, Loitering, and Intrusion detection functionality:

Line Crossing Detection

The Line Crossing detection detects one or multiple persons crossing a virtual trip-wire. The traffic direction can be assigned on screen for persons passing the line in one specific direction or in both directions.

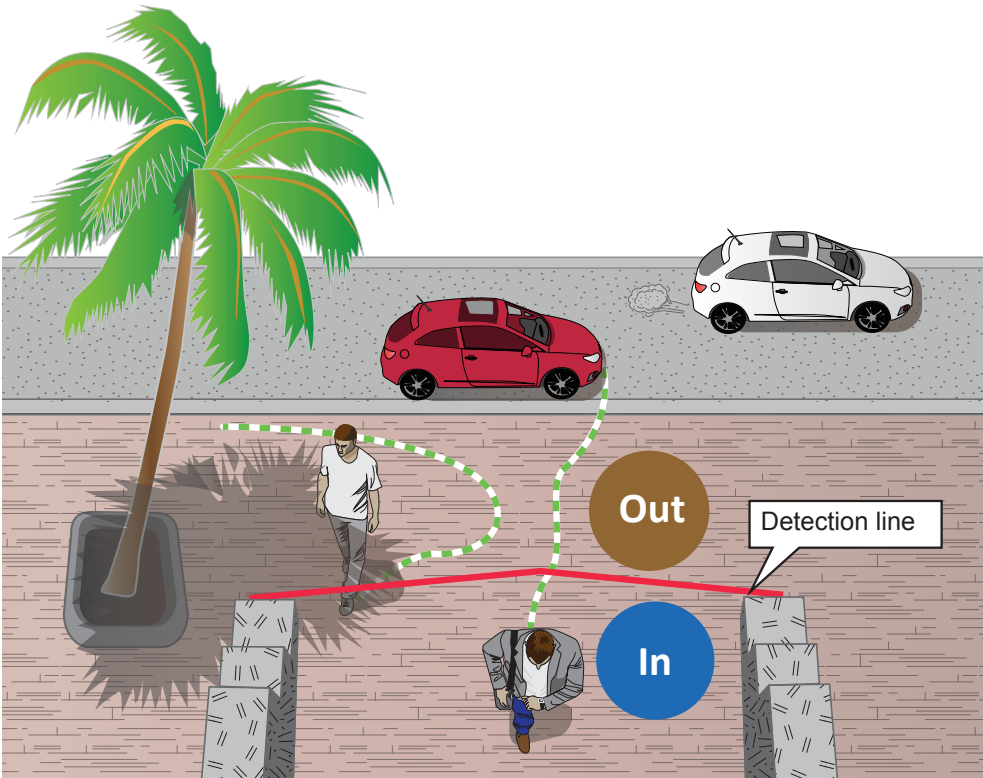

The applicable scenarios of this feature can be:

- * Detects someone who enters a drive way, entrance, or exit through the virtual line.
- * Detects and triggers an alarm in a predetermined direction.
- * The detection line can be used as a fence boundary to know if someone has crossed the articulated line around a perimeter.



Loitering Detection

The Loitering detection can be used to detect a person or a group of people lingering in an area for longer than a preset time threshold.

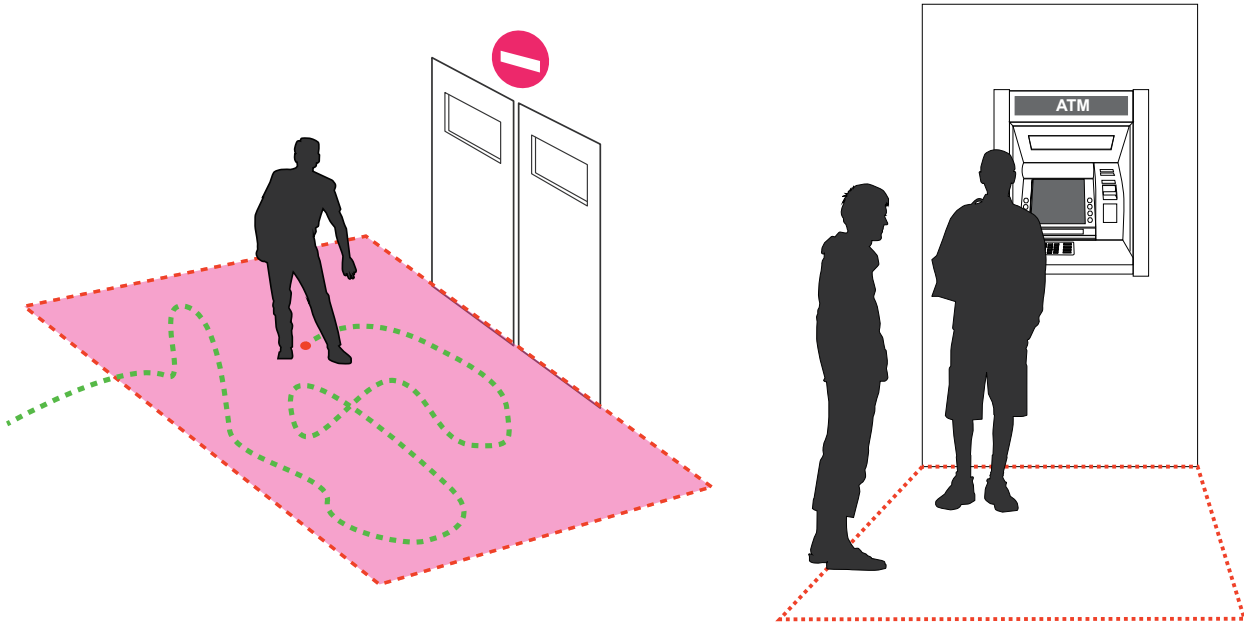

Intrusion Detection

VIVOTEK Intrusion Detection can be used to detect people entering or leaving a virtual area in the camera field of view.

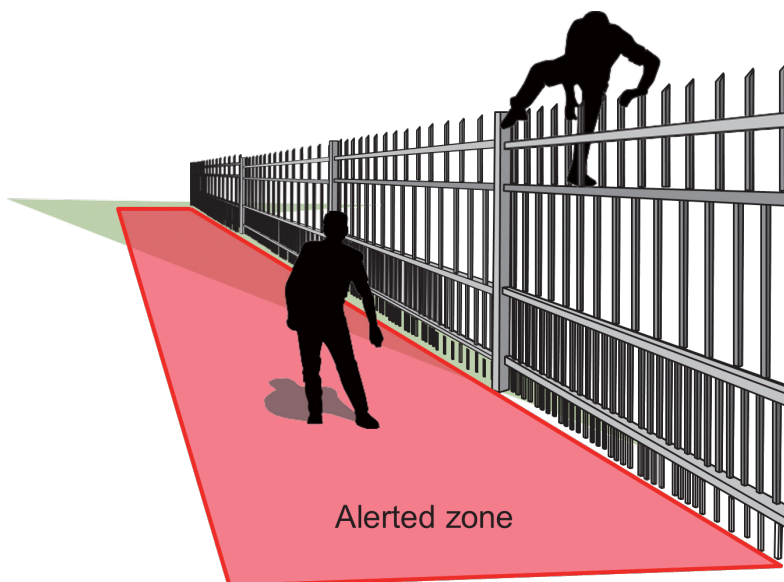

The applicable scenarios of this feature can be:

- * Detects when a person enters a bank vault or school after the office hours.
- * Detects when a person leaves an emergency exit or fire escape, or any place that is normally forbidden from access.



To use Smart search,

1. Use the date and time selectors to specify a time span on which to perform the Smart search.
2. Select a Type (Smart motion, Line crossing, Loitering, or Intrusion). Selecting Line crossing detection may require you to adjust the position of the detection line.
3. There are different parameters for each detection Type. Refer to each VCA feature's documentation for details. You can tune the parameters for each VCA feature. See next page for the configurable parameters.

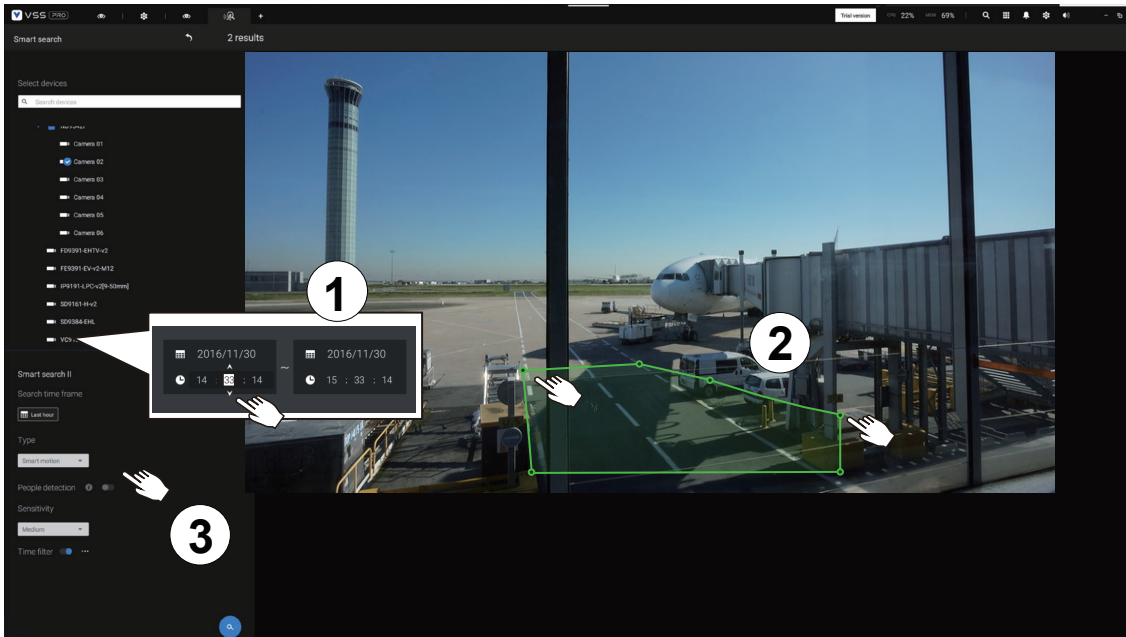

4. You can draw one polygon with multiple mouse clicks to include areas where activities of your interest have occurred. You can draw one or more cross lines for Cross line detection. Double-click to close a polygon.
5. Click the Search button.

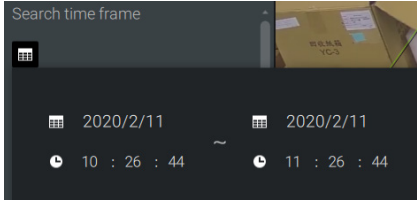

Search parameters:

Search time frame	Use the calendar tool pane to specify the time span within which the activities in scene will be searched.			
				
Type	If the selected camera supports multiple Smart VCA detection features, the supported types will be listed: Smart motion, Line crossing, Loitering, or Intrusion.			
Parameters (determined by Type)	Smart motion	Line crossing	Loitering	Intrusion
	People detection*	People walking direction	Stay time	Direction: Into the zone / Leaving the zone
	Sensitivity**			
	Time filter			
* People or Vehicle detection	People or Vehicle detection enables the display of the alarms detected via the human or vehicle silhouettes algorithm. This can be used to filter out video analytics alarms that are not related to human or vehicle activities, such as swaying vegetation, or small animals.			
** Sensitivity	Configure the sensitivity for the detection of the activities in scene. Low for near scene, high sensitivity for long distance scenes.			

Note that different cameras support different VCA functions. Please refer to the documentation for Smart VCA or Smart tracking features, such as the [Smart VCA User Guide](#).

IMPORTANT:

Running Smart Search II requires cameras that support the following:

1. Smart motion.
2. Firmware version above 0113d, 0117b or 0100i (Authwebsocket support is needed)
3. VCA package version above 6.1.3a.



NOTE:

- * Smart search II supports people detection whether the camera comes with a Smart motion license or not. However, the Line crossing, Loitering, Intrusion features will not be available.
- * With a valid VCA package and license, the abovementioned features will be available in the Smart search II.

In most cases, it is presumed that you have configured VCA detection zones and detection rules such as lines to detect people crossing. You can also configure a detection zone or lines on the VSS server and then search for the detection results from the recorded videos.

If your camera supports Smart VCA features, you can manually create detection rules on the configuration screen. Note that you may not need to do this if you have already configured detection rules on the camera.

1. Select a VCA camera.
2. Select a VCA type from the pull-down list: Smart Motion, Line crossing, Loitering, or Intrusion. For a camera that supports only one VCA feature, such as Smart tracking on a speed dome, there is no "type" option.
3. You can then draw a detection zone, or detection line on the screen.
4. Select a time frame using the calendar tool.
5. Select to enable or disable the People detection feature and configure the Time filter, or other parameters.
6. Click the Search  button.

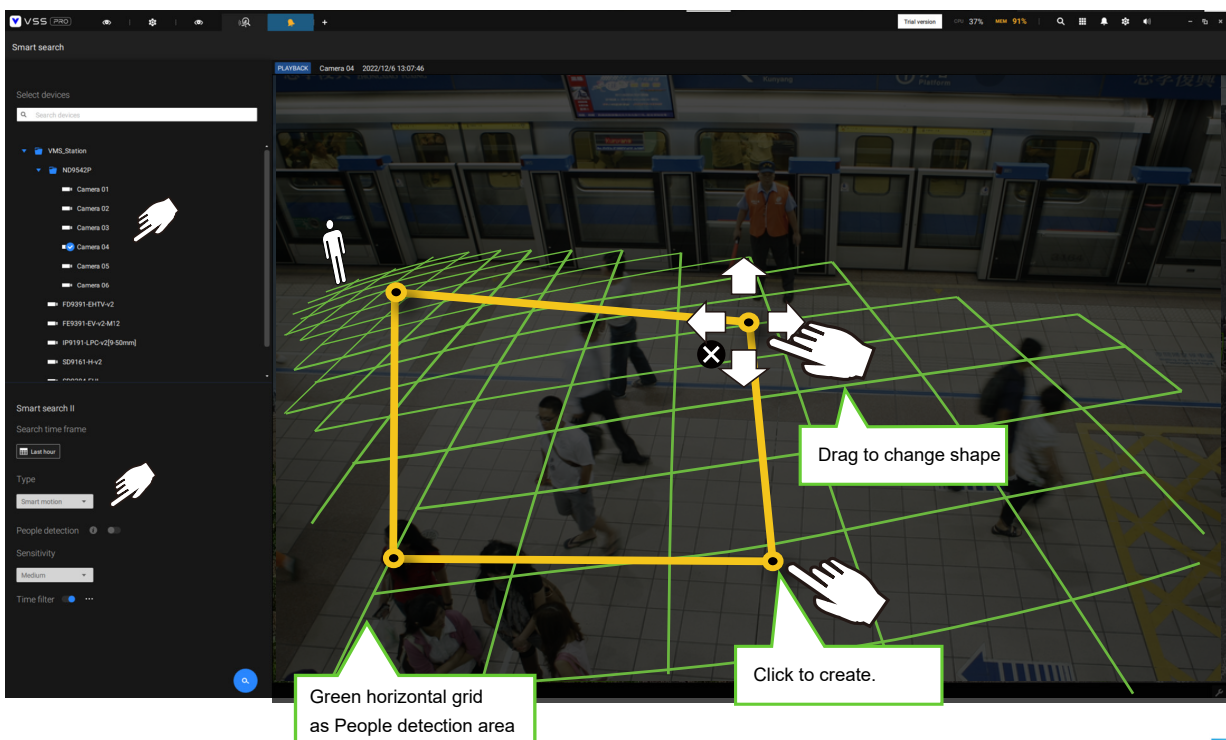

4. The search results display as the snapshots of the associated video clips. Click to playback the video clips with activities in the detection zones.

Hover the screen with your mouse, and the length of each video clip is displayed.

Note that unless interrupted, the playback continues with all detection zone clips, by continuing to the successive clips.

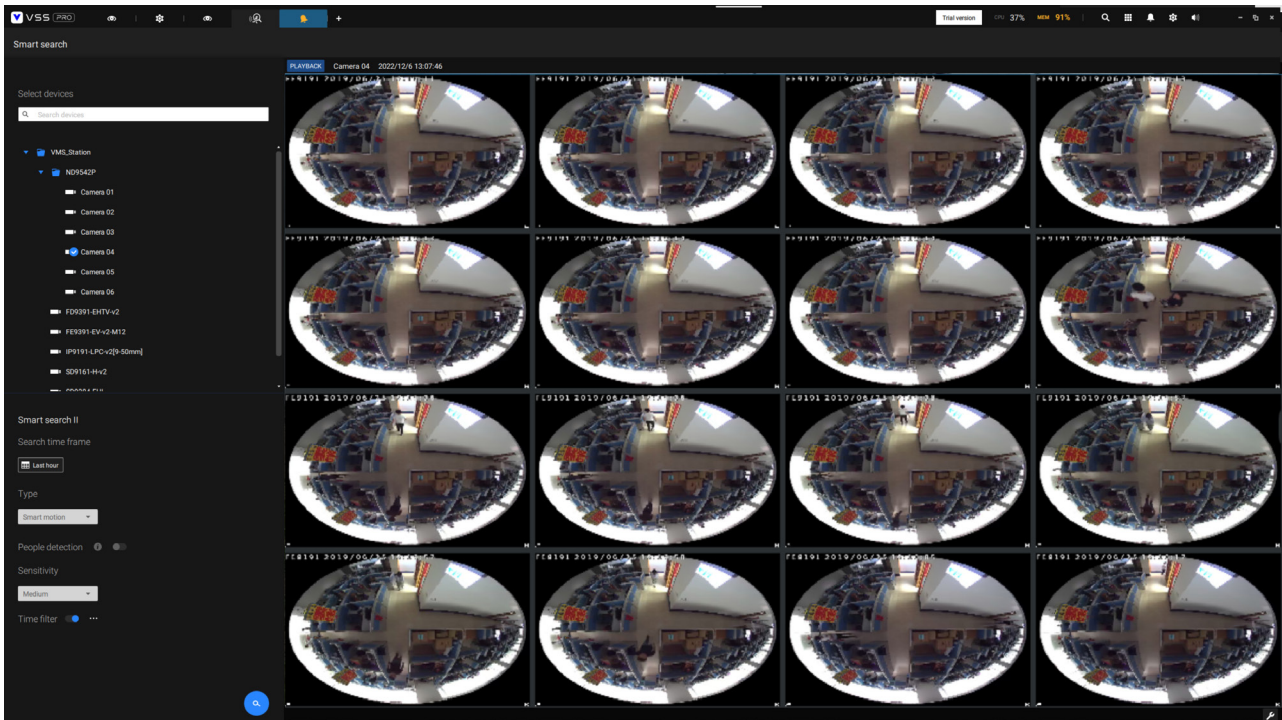

Smart search II is available only for newer line of cameras that come with **Smart Motion detection** and other **Smart VCA** features. Smart search II has the following benefits:

1. **Faster search:** Metadata is saved with videos coming from the cameras running Smart VCA detection. With the help of the metadata, the search focuses on the effective alerted vectors and the adverse effects, e.g., headlights causing dramatic contrast or small animals passing through, have already been eliminated by the camera. The search can be more rapidly completed.
2. **People detection:** The search can be conducted for human activities only. Activities matching the silhouettes of human will be considered as effective results.
3. **Multiple-point polygon:** Users can select a region of interest by drawing a easily-configured polygon. In addition to the pre-configured detection rules on VCA cameras, users can create their own Smart VCA Detection rules on the VSS search panel screen.

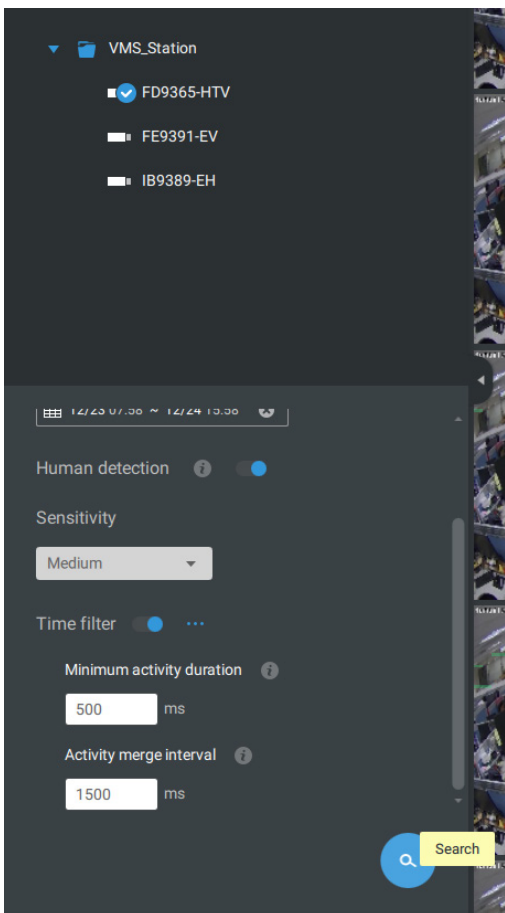

You can specify the time span, People detection, Sensitivity level, and time filter parameters in a Smart Search II panel.



5. You can then click to open any clip of your interest. Each marked event clip will be indicated by a lighter color on the time line. Select and double-click on a video clip, and then right-click or select the bookmark or snapshot functions from the upper-right.

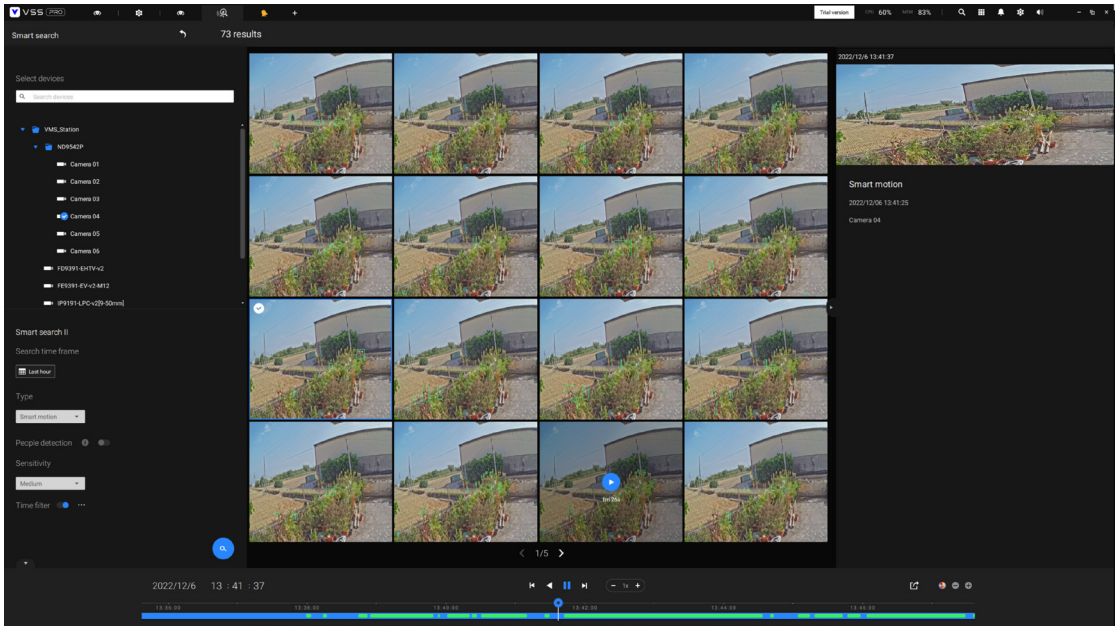

Move your cursor to the upper right corner of the playback window to display the Snapshot and Bookmark buttons. Use them to configure the current play time as a bookmark or take a snapshot.

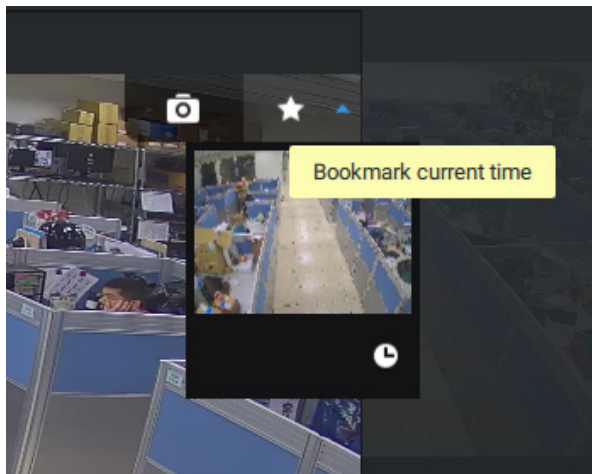

While in the full-screen Playback window, you can right-click to select or deselect the display elements including motion cells, tracking block, and tracking dot.

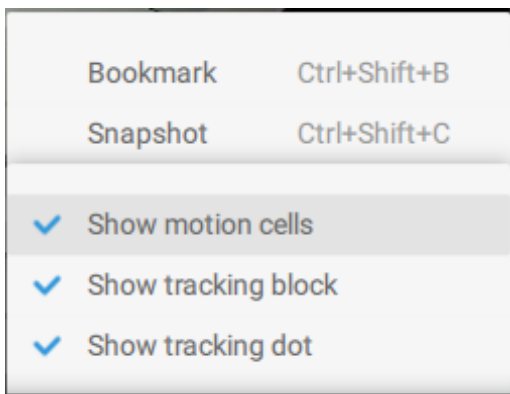

6. If you find important events, use the Export function to mark the start and end points on the timeline to export a video clip. Use the pull tabs on time line to determine the export length. By default, the export length is 2 minutes long.

The playback control in the Smart search window is identical to that on the Playback window.

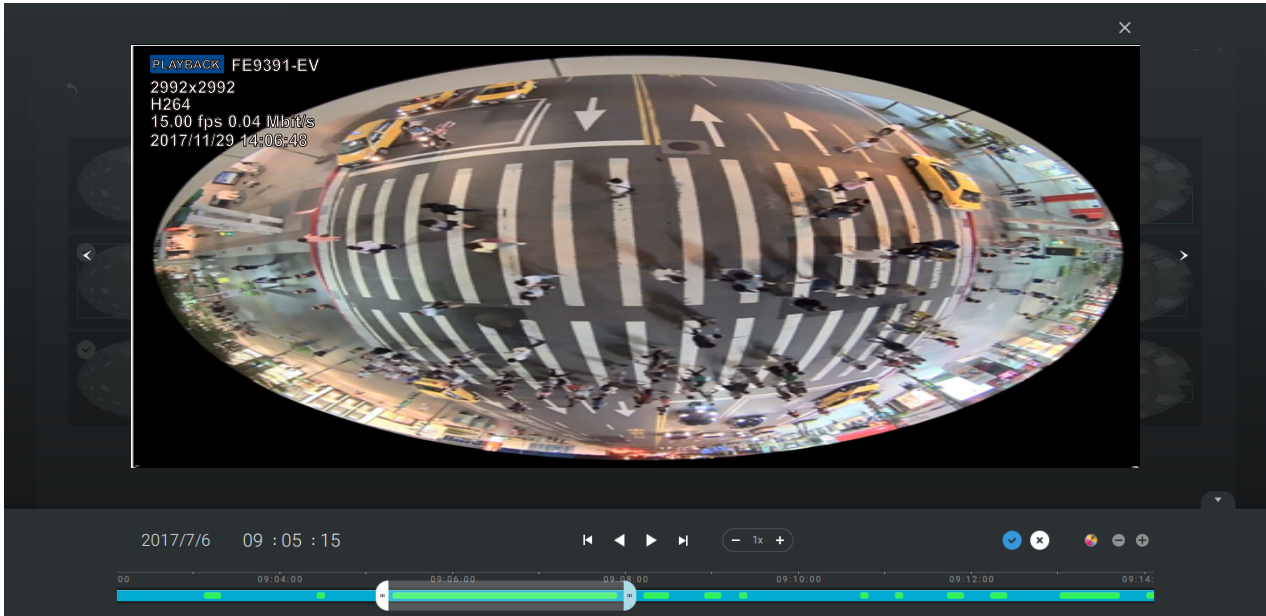

Different events on the timeline are indicated by tags of different colors. Click on the event highlights button to verify their colors.

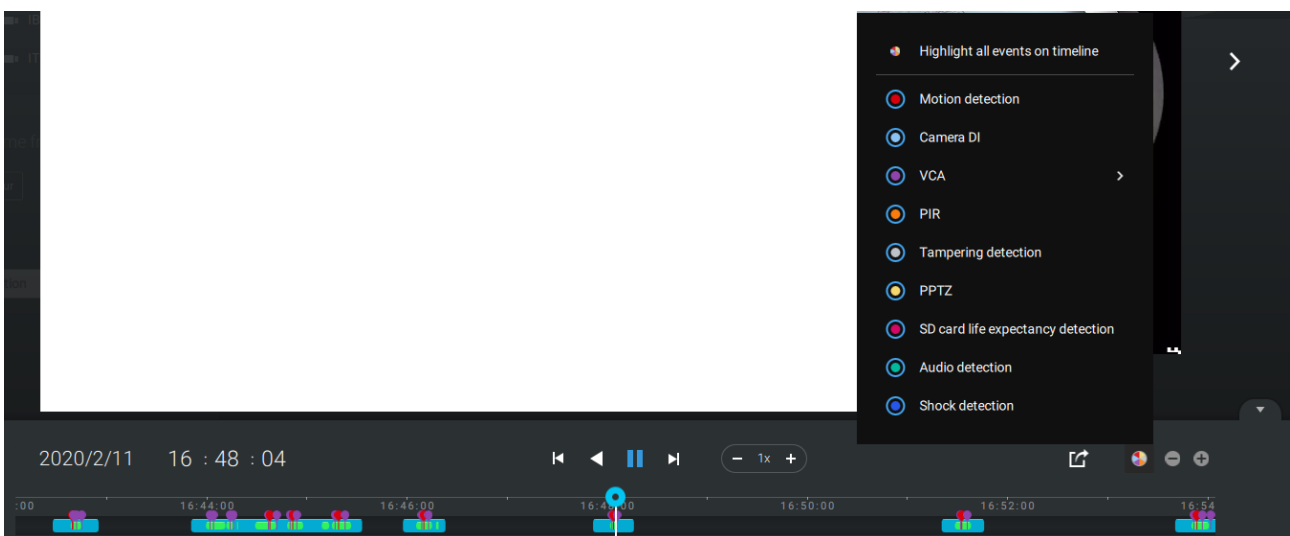

2-20. Deep Search

The Deep Search function uses AI empowered by VIVOTEK AI cameras to improve search functionality, and it comprises three main functions: Attribute Search, Scene Search, and Re-Search (VSS Professional edition only). Without relying on scrolling through the video footage frame by frame, VIVOTEK AI cameras provide object-based metadata to enable intelligent video evidence search. By utilizing object-based metadata-defined attributes and rules, Deep Search helps users search for the target of interest smarter and faster.

To use the Deep Search function, make sure you have enabled the Deep Search function, added the cameras that support Deep Search and have the time synchronizing among VSS client, VSS server, and cameras. There are two ways to access the Deep Search function; one is to click the search icon and select Deep Search, and the other is to click the associated icon  on a live view cell.

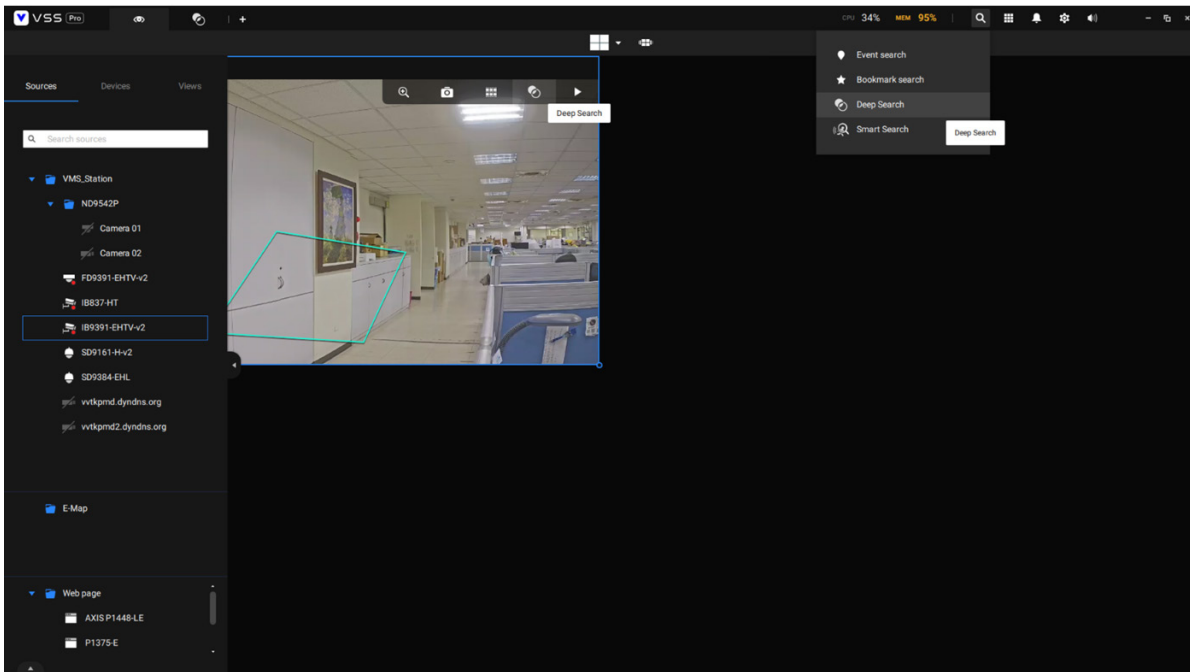

Select the object type in the configuration area, including people, vehicle, people appearance, and vehicle appearance. Select people or vehicle objects if you want to search people or vehicles in the recorded video. Select people appearance or vehicle appearance object if you want to find people or vehicles and know their appearance.

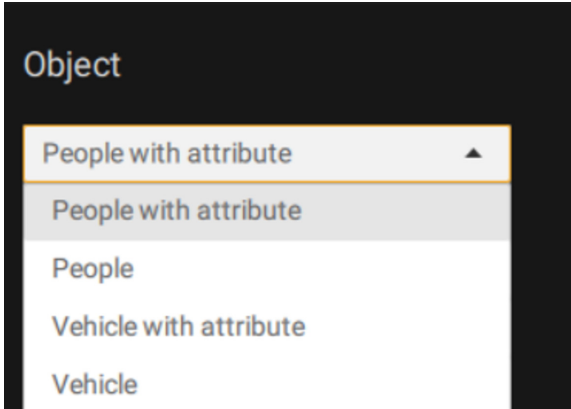

Note that not all cameras support finding all the object types. When users select one type of object, only the supported cameras will appear in the camera list.

By default, all the cameras that support the object type will be selected. Users can click the device list and choose the cameras.

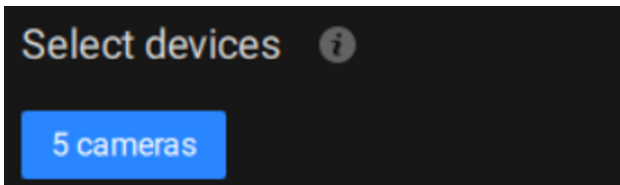

Select a time frame using the pull-down menu.

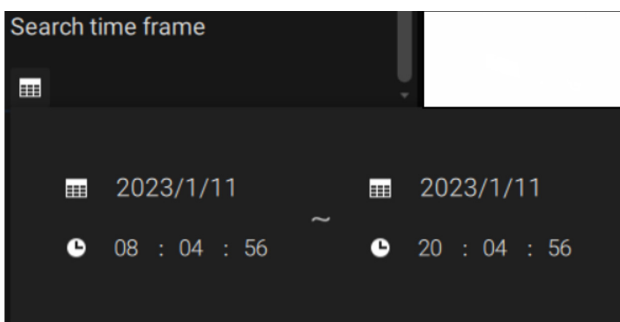

Select Scene Search or Attribute Search.

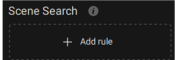
3A. Scene Search: Search for the object appearing or lingering in the virtual area or crossing a virtual tripwire. Note that this search can only be used if you select a single camera. Users can click the  button to select a search rule type.

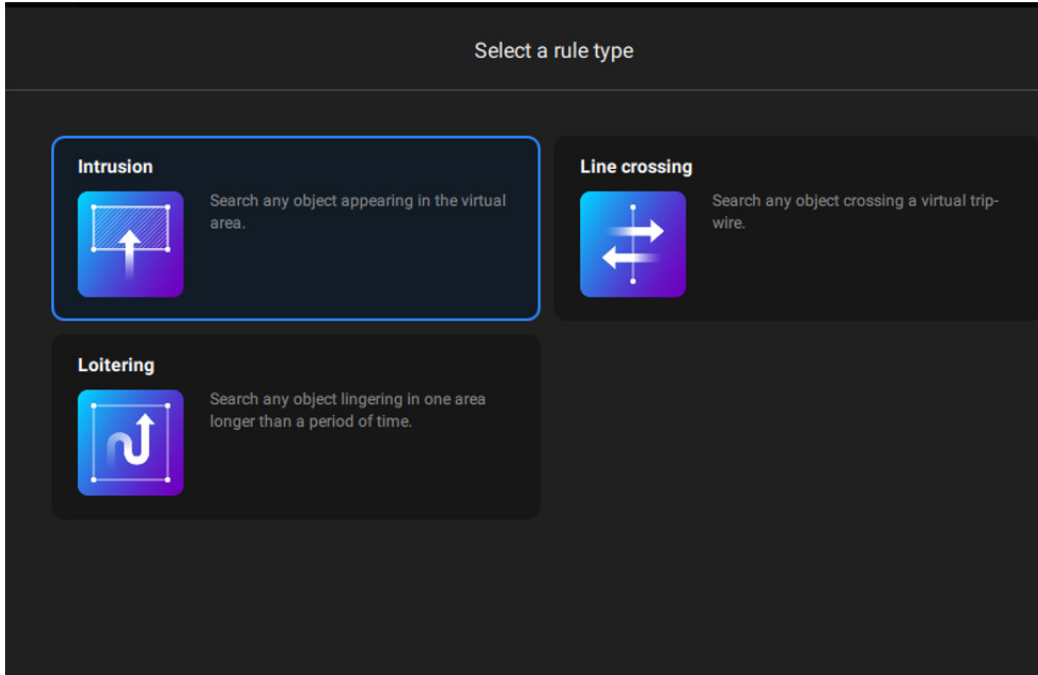

- Intrusion: Draw a closed area in which you want to find related people or vehicles staying in this virtual area.
- Line crossing: Move the nodes to draw a tripwire to find related people or vehicles crossing this virtual wire.
- Loitering: Draw a closed area in which you want to find related people or vehicles staying in this virtual area for more than a specified period.

If there are search results after performing Deep Search, you can play each corresponding video thumbnail and take snapshots as needed.

3B. Attribute Search: filter the object with selected appearance. Note that this search is only available when users select the people appearance or vehicle appearance object. The supported appearance for vehicle and people is listed in the table below.



Object Appearance:

- People with Attribute

People -> Gender, Age, Clothing color

Accessories -> Backpack, Hat

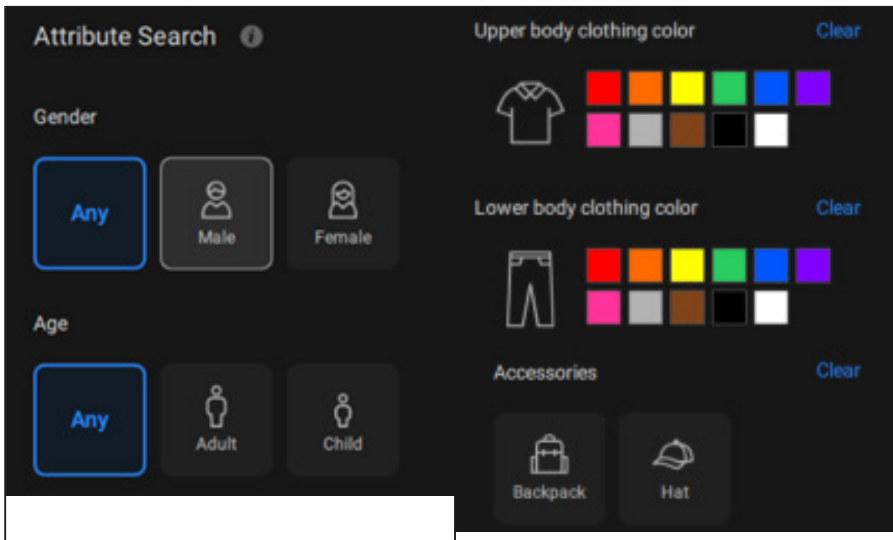

- Vehicle with Attribute

Vehicle -> Type, Color

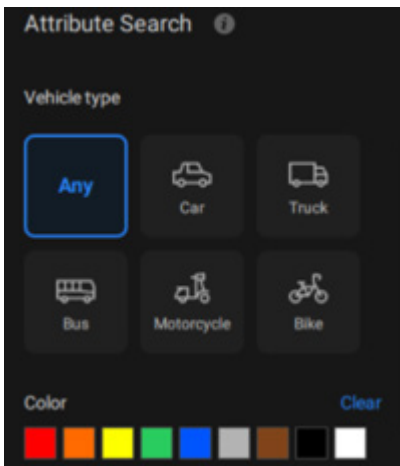

Click the search icon, and the results will display in the results area. The number of results will be shown at the top of the results area. Each result contains a snapshot of the object and a video clip of trajectory for the object, and user can click the video clip to playback the video. Also, users can click the sorting icon on the top-right of the results area to sort the results from the latest to the earliest or vice versa. If there are more than 200 search results, only the latest 200 results will be listed. Hence, by default, the first 200 results will be listed if the time is sorted from the latest to the earliest.

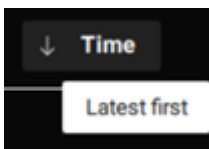

The first 200 results will be listed if the time is sorted from the earliest to the latest.

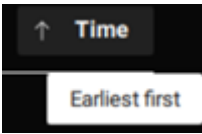

VIVOTEK AI cameras with supported Deep Learning VCA package versions can capture and provide not only body snapshots and metadata but also face snapshots and metadata to VSS. Users can see object details, including snapshots and attributes, by hovering over a snapshot.

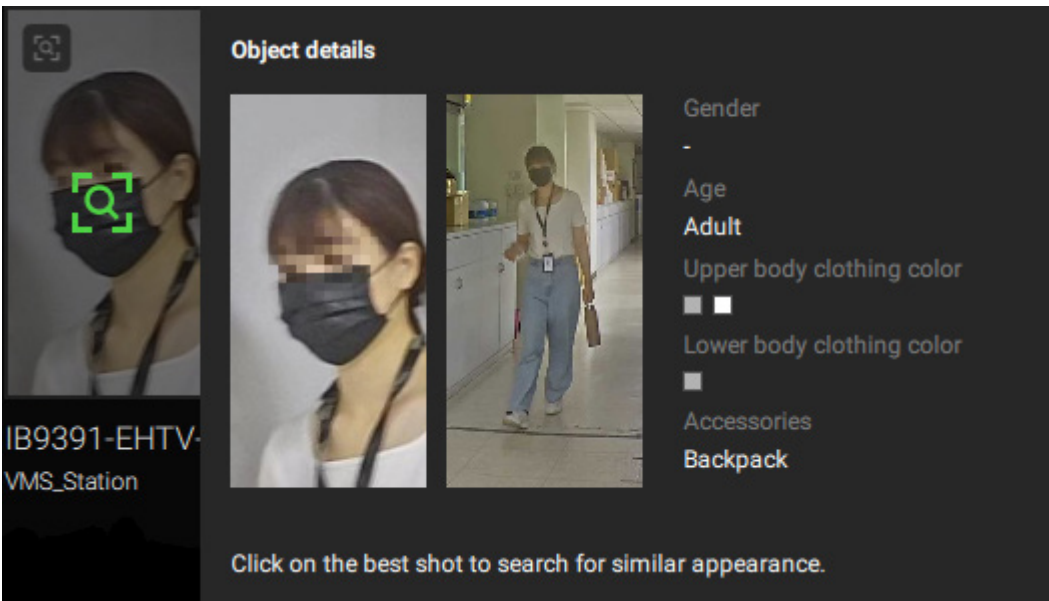

Re-Search (VSS Professional edition only):

After all the search results shown by the above three filters, users can click the snapshot of the object to search for similar appearance. Users can select to apply Re-Search based on:

- Current selected device and time frame: Click "Search with current settings" to start Re-Search based on the currently selected device and time frame.

or

- Custom settings: Click "Search with custom settings" to start Re-search based on the re-selected device and time frame.

When Re-Searching the face snapshot of an object, the results will show both objects with similar faces and similar bodies in the descending order of similarity.

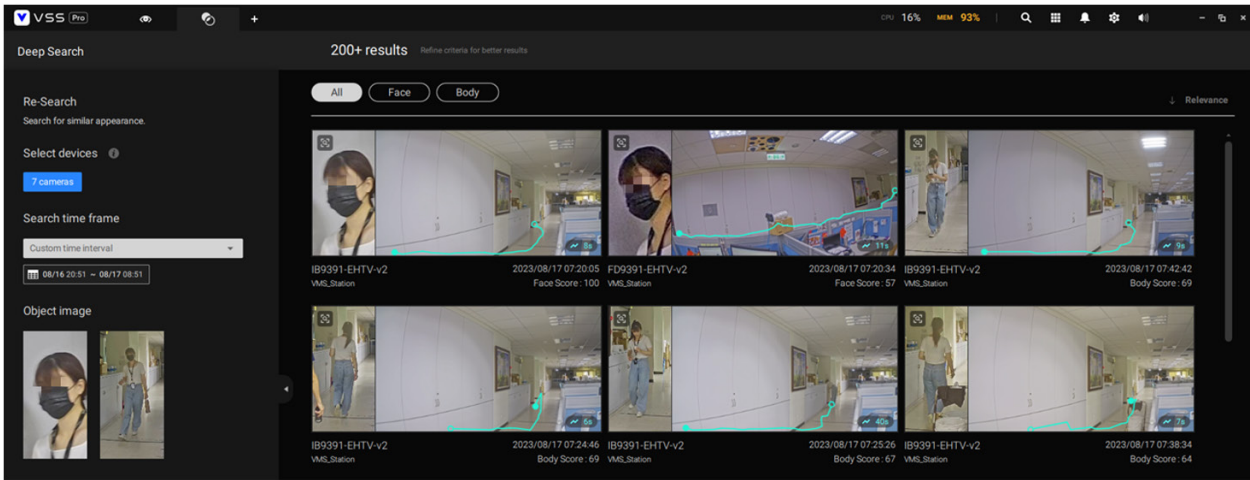

Case Vault (VSS Professional edition only):

The Case Vault function enables users to curate a personalized list of interested objects' video clips discovered through Deep Search. Once added to the Case Vault, the videos are organized chronologically for easy review and report generation.

How to Add Videos to the Case Vault?

Perform a Deep Search or Re-Search to find relevant video clips. In the upper right corner of each video clip, locate the "More" menu. Open the "More" (...) menu. Choose the "Add to Case Vault" option to include the video in the Case Vault list.



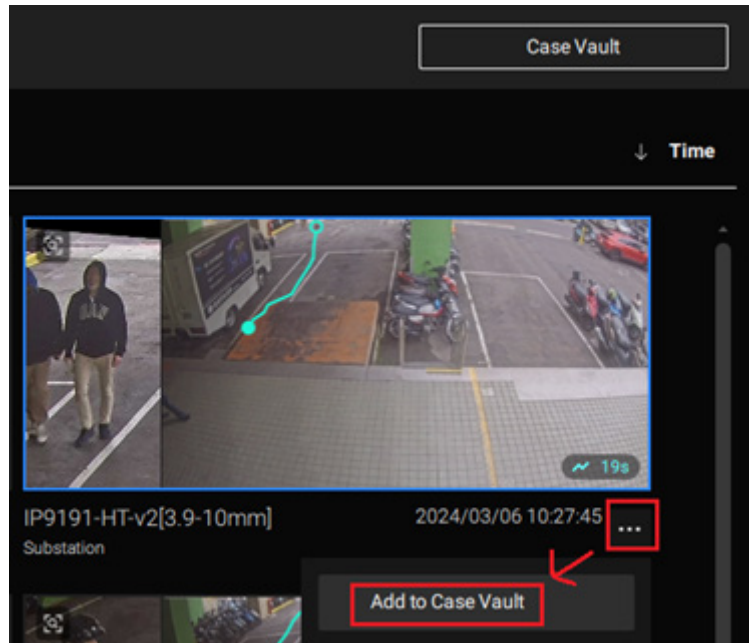

Case Vault Functions

1. Quick preview in Case Vault

The added videos will be automatically arranged in the Case Vault based on the time of occurrence. Users can delete unwanted videos. Hover over the video screenshot in the Case Vault to play the video at double speed for quick previews.

2. Case Vault Playback

Click on the "Play all" button, and Videos will play in a larger screen format, seamlessly transitioning based on their chronological order. On the video playback control bar, click on the "Show related E-Map" icon to view the cameras associated with the currently playing video in their designated positions on the E-Map.

Note: Only one E-Map will be shown if one camera is placed on two E-Maps.

3. Report Generation

Automatically generate a comprehensive report based on the content of the videos in the Case Vault.

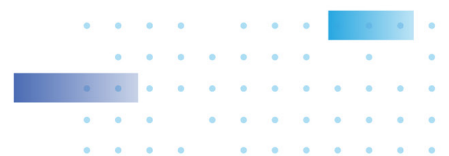

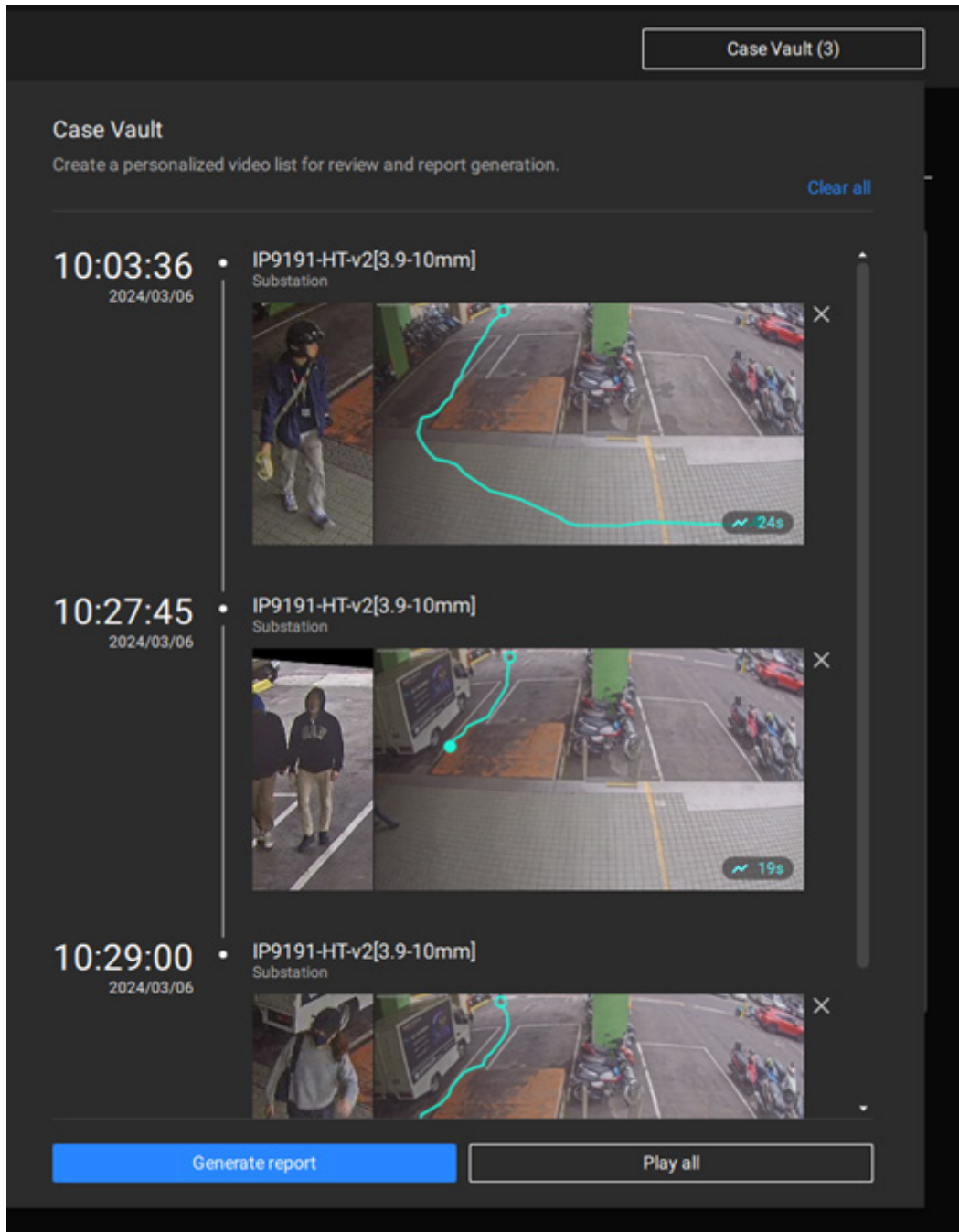

After reviewing the videos, click the "Generate report" button in the Case Vault. A report window includes the object's best shots, and video clips from the Case Vault will appear for editing.

In the report's top right corner, click "Export" and choose to export the report as a PDF file or export all videos from the Case Vault.



IMPORTANT:

1. Starting from VSS v1.1, the object containing at least one selected color for the clothing or vehicle will be listed in the search results when one or more colors are selected in the clothing or vehicle color option. For full compatibility, it is recommended to upgrade both the client and servers/substations to the latest software/firmware version.

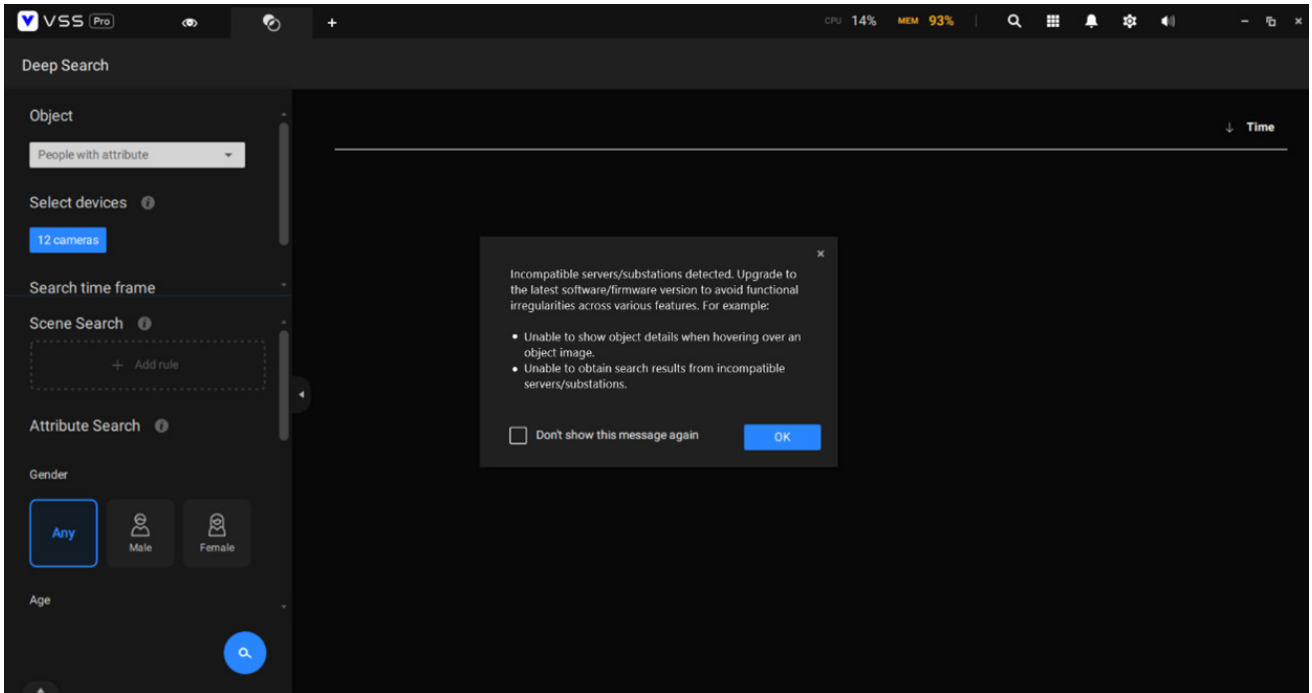

2. When searching for people with accessories, the search results will show people with both backpack and hat.

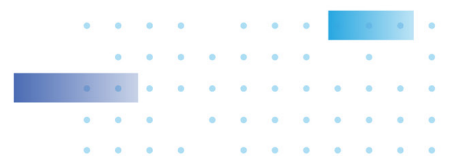
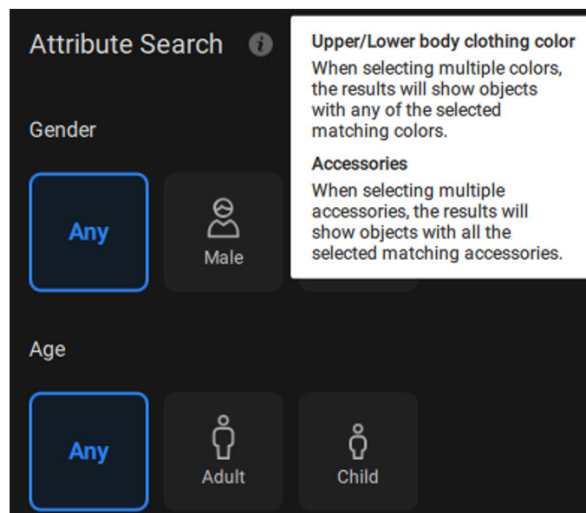

- When searching for motorcycles or bikes, color attributes are not supported.

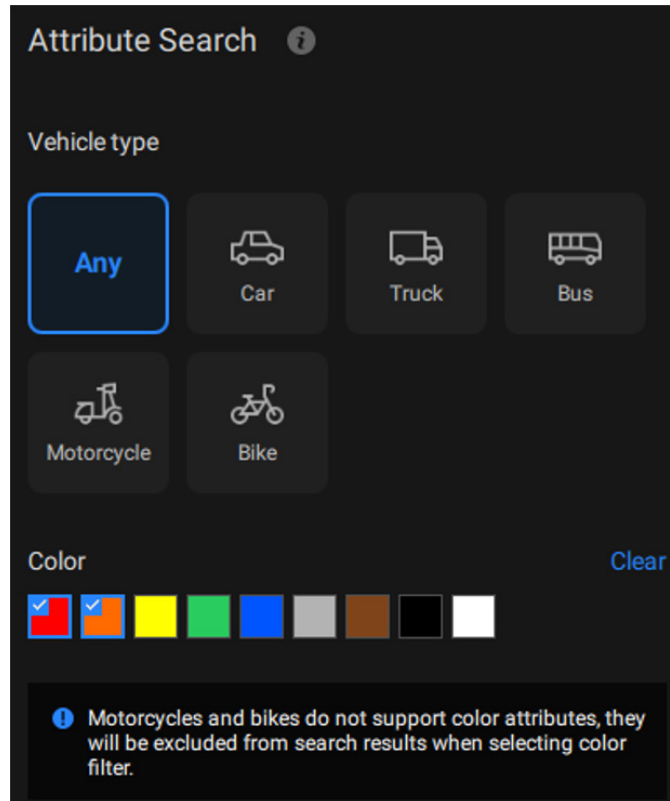

- For Re-Search, a broader time frame and more selected cameras result in a longer search time. If the VSS server is busy checking and calculating a significant amount of metadata, it may reach a 90-second timeout with no search results. To avoid this scenario, consider shortening the time frame and reducing the selected camera count, and keep in mind that CPU and storage throughput will also influence the search speed.
- The snapshots and metadata of Deep Search are stored in the same path as recordings and recycled based on the recording recycle setting. An object can generate approximately 0.25 MB of data. For mid-to-high activity scenes, such as parking lots, with about 10 objects per minute, the data capacity can take up approximately 150 MB of storage space per hour per camera.
- To comply with regional privacy laws, the Deep Search function can be managed by users with an admin account in Settings > Preferences > Station > Deep Search.
- Please refer to the VIVOTEK'S website and check supported cameras for Deep Search. (<https://www.vivotek.com/ai-driven/deep-search-system-requirement>)
- With a newly added camera, Deep Search takes 3 to 5 minutes to acquire search data. The searched results will be acquired after another 2 to 3 minutes.



Chapter 3: Applications:

3-1. I/O DI/DO Devices

IO Box and Related Configuration

Use the software utility that comes with the IO box, e.g., Advantech's Adam/Apax.NET utility, to configure IP address, and test the DI/DO connectivity. The connections to external devices should be completed before configuration on the software.

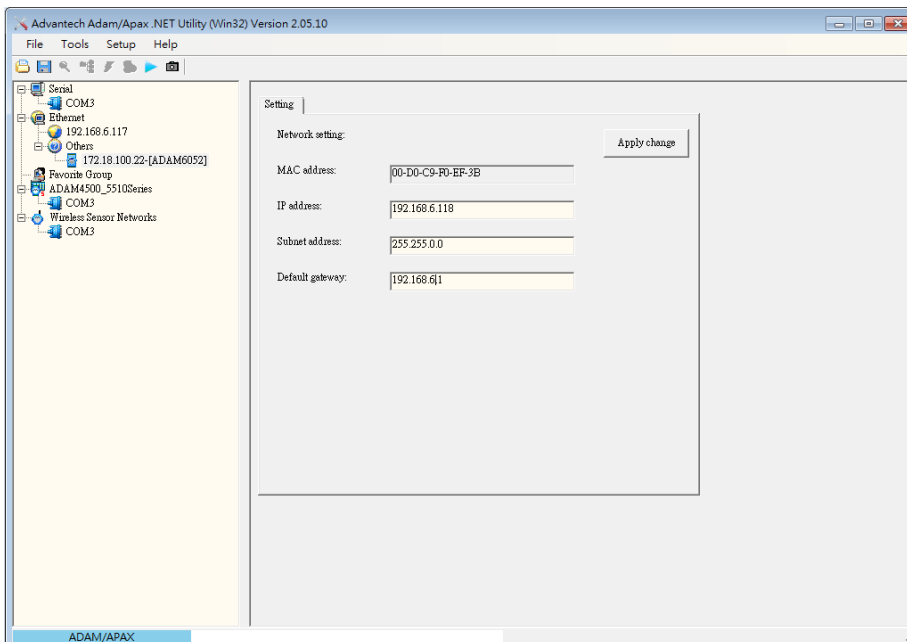

Enter Settings  > Device > DI/DO Device. Click the add I/O button on top.

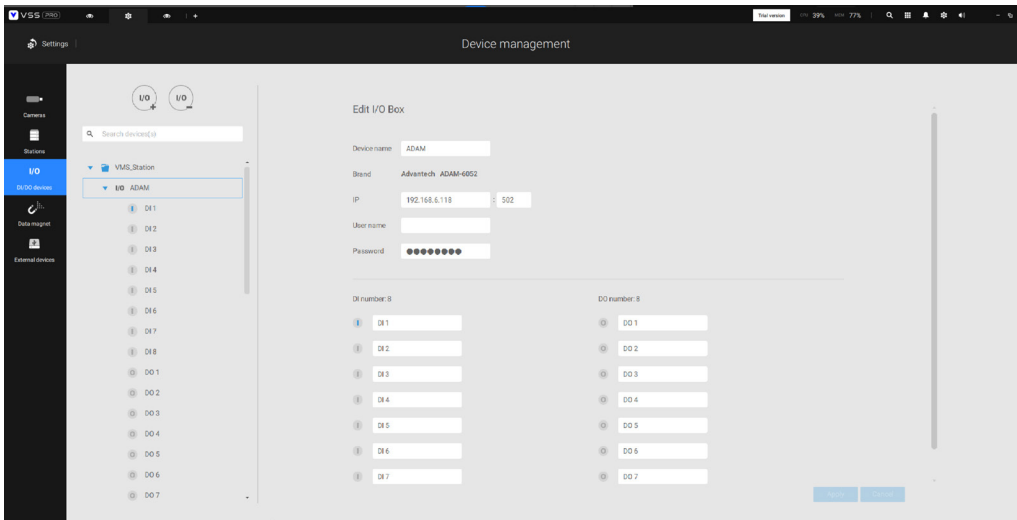

Enter the I/O box's IP address and credentials, and select the correct model name from the pull-down list on the right. Click the Apply button to proceed. The current I/O connections are also displayed on screen, such that the status is displayed when DI pins are connected to detection devices.



Configuring I/O Box DI/DO as a Trigger or Action in Alarm

Enter the Settings  > Alarm window. Click the Add alarm  button on top.

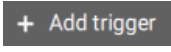
Select the External Device event , and then click the Add trigger  button.

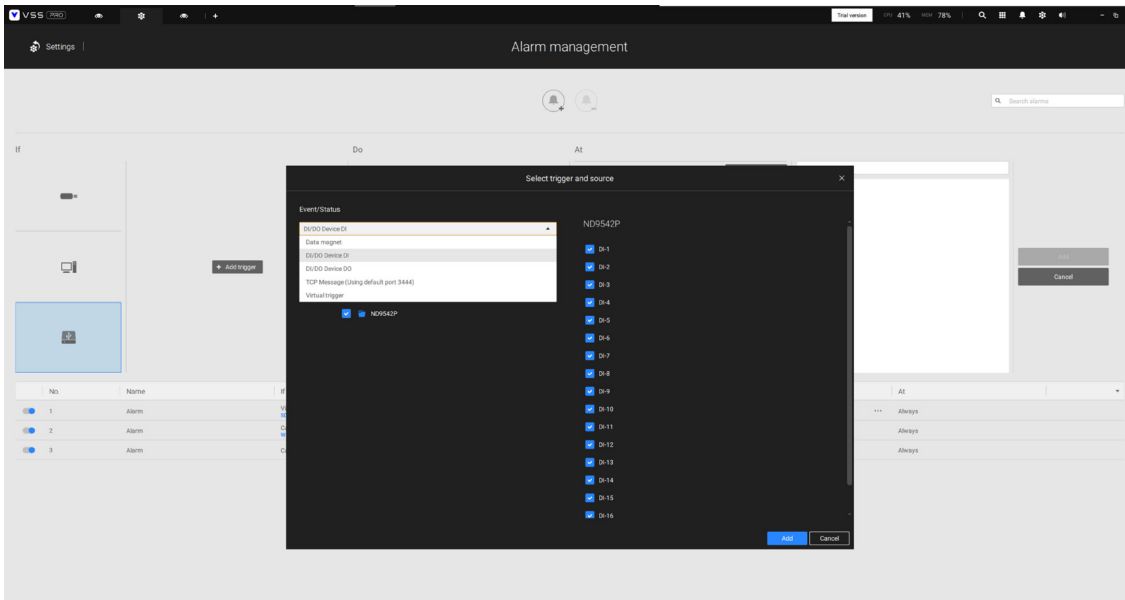

The Select trigger and source window will prompt.

Select either the I/O Box DI or DO as the triggering source.



Select one or multiple DIs as the triggering source and click the Apply button.

Click Add action **+ Add action**, and select a corresponding action, such as sending live streaming, record videos, trigger a DO, sending an HTTP request, or sending an Email. When done, click the Add button.

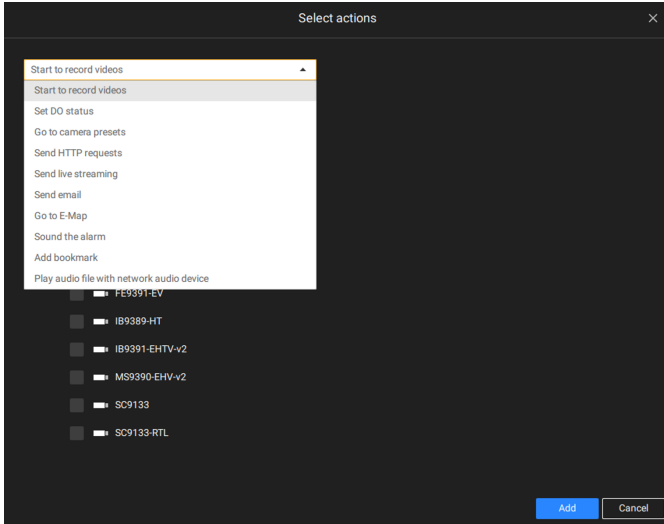

Configure a schedule during which the Alarm configuration will take effect. If no special time span is needed, you can simply select Always.

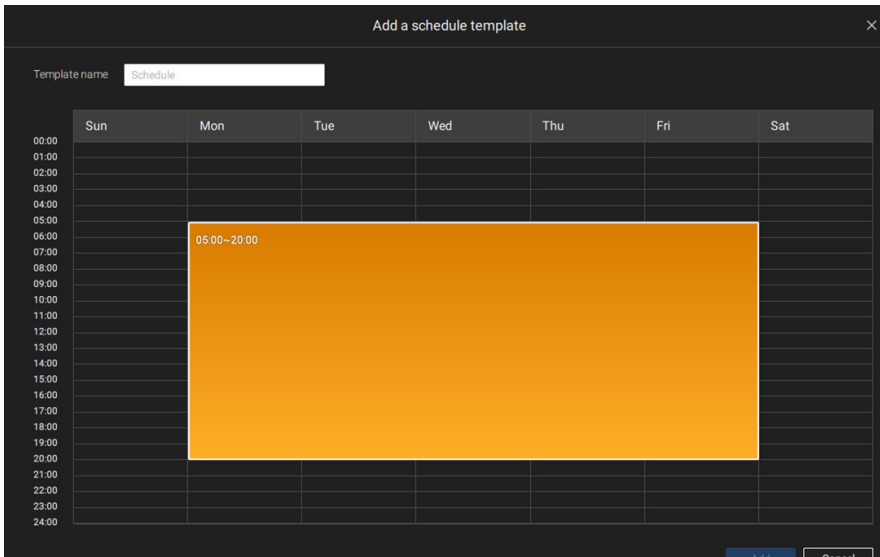

Enter a name for your Alarm, and add description for your configuration, e.g., "intrusion detected on the front door." When done, click the Add button. The Alarm configuration takes effect immediately.

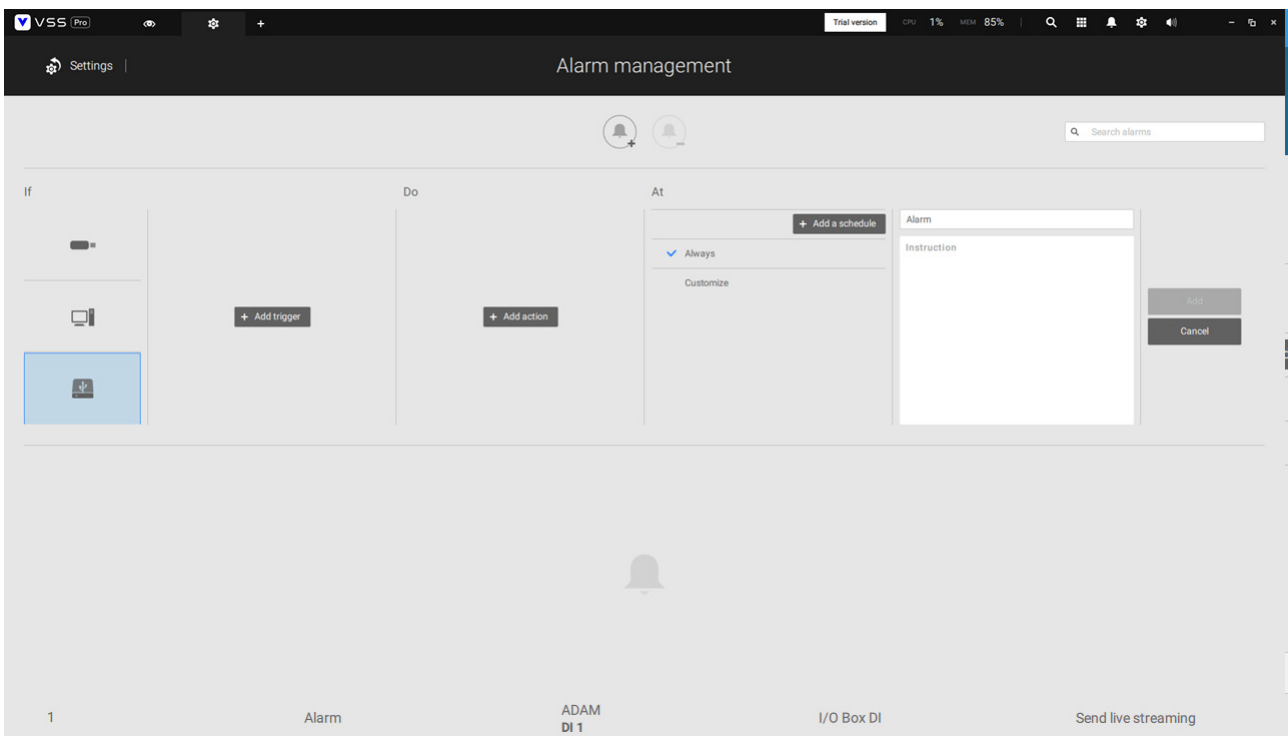

NOTE:

If an I/O module is started later than the VSS server, you may not be able to access the I/O module. You should then re-start the VSS service.



3-2. Configuring Redundant Servers - Failover

VSS servers can be configured into two groups: Active and Redundant. The Active group performs daily recording and monitoring tasks, while the Redundant group acts as the standby servers. In the event of server failures, the Redundant group becomes active, and takes over the recording task.

The Redundant server group configuration consists of the following:

1. One VSS server designated as the CMS (Central Management server) VSS central management server. Another VSS server can serve as a CMS failover server.
2. At least one VSS server in the Active group.
3. At least one VSS server in the Redundant group.
4. Gb/s network or higher-speed connections among the servers. All Active and Redundant groups can reside in different subnets, provided that static IPs are configured for these servers.

IMPORTANT:

For a Redundant server configuration, you must first enlist VSS servers in the Stations configuration page before configuring the Redundant server groups. See the Stations configuration page.

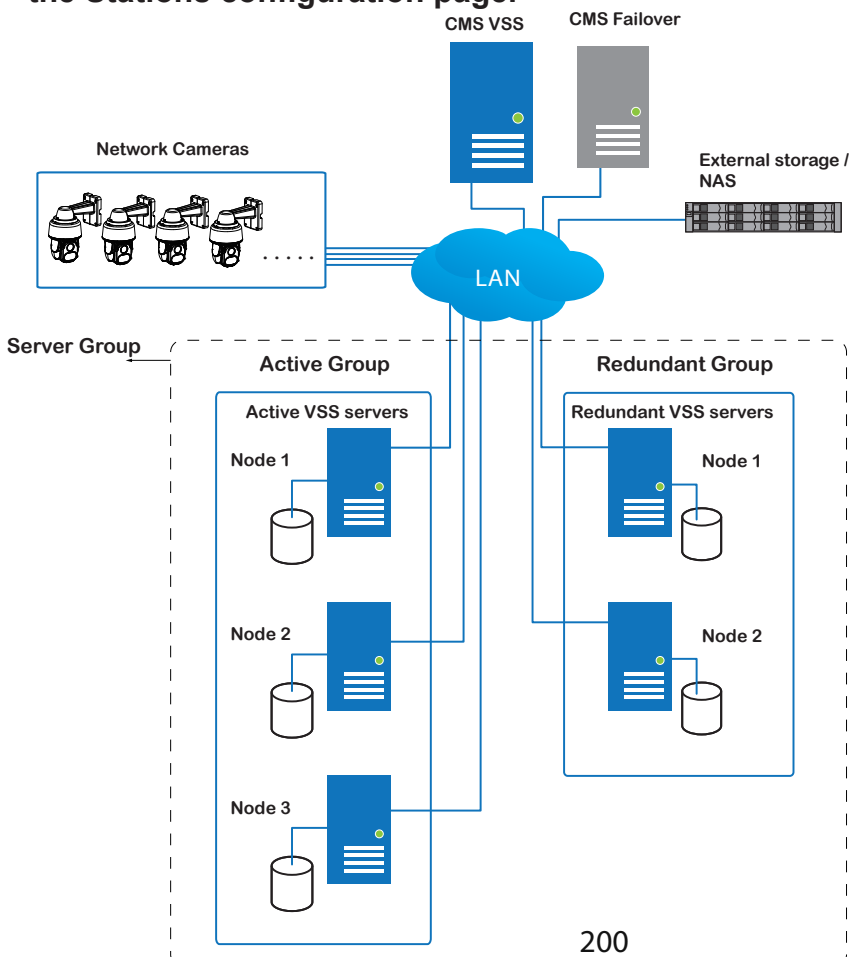

Below are the definitions of server roles:

1. CMS VSS server: The main access portal for the configuration.

1-1.	CMS server is where the Failover configuration takes place.
1-2.	CMS continuously polls to check the hearbeats to monitor the statuses of all Active and Redundant servers.
1-3.	CMS backs up the configurations on active servers twice per day (8:00 am and 20:00 pm). Suggest to manually apply the configuration while the license of active servers change to prevent unexpected incident occurred before daily backup.
1-4.	CMS assigns redundant server(s) to the takeover of a failed Active server.
1-5.	In a Redundant server configuration, the CMS is supposed to be up and running at all time. If the CMS server fails, the server failover and failback operation will not take place. It is therefore preferable to configure a CMS redundant server, and install the CMS server at a high up-time environment, such as on a VMWare configuration.

2. CMS Redundant server: This is a failover server that serves as the backup for the CMS server.

Note that this redundant server is configured in Settings > Devices > Stations. Click Add Stations, and select "Add as a redundant server for" "CMS." See next section for the configuration procedure.

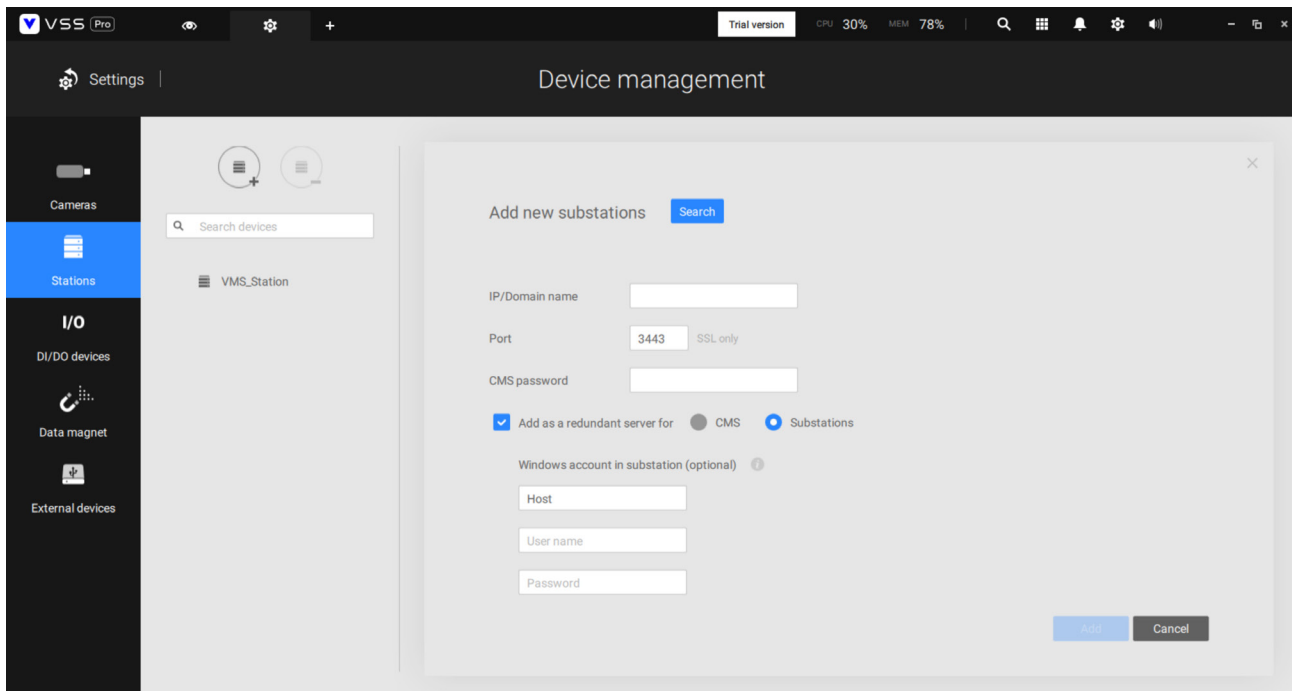

3. **Active servers:** Active VSS servers are the work horses that perform recording and monitoring tasks.
4. **Redundant servers:** The Redundant servers are actually active-standbys. They participate to continue video recording in the event of active server failures. It is recommended for the Redundant servers to have an equivalent or higher processing power than the Active servers. The same applies to the size of storage volumes and the disk drives' write performance.

Note that you cannot configure a Redundant server by opening a local console.

The conditions during the failover process are illustrated below:

Multiple Active and Redundant groups can be created.

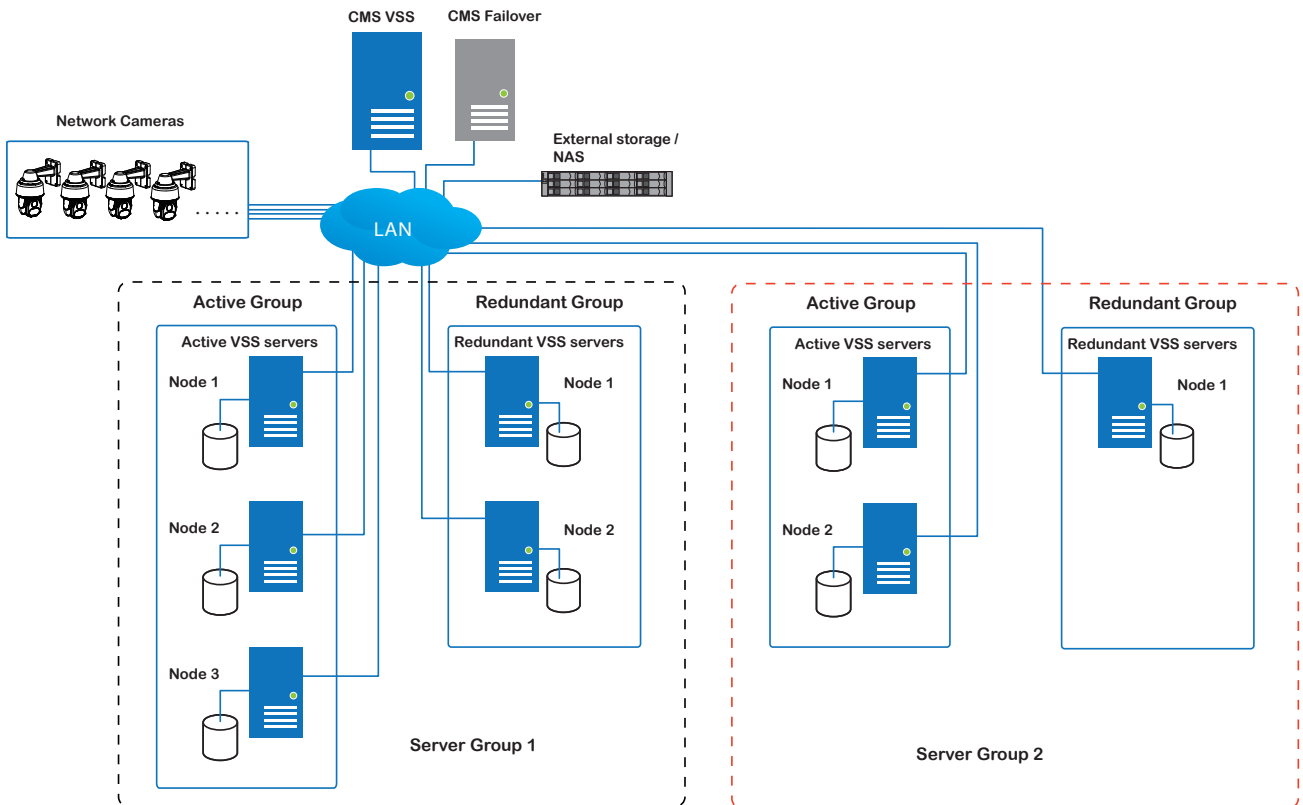

Each Redundant server can serve as the backup for ONE Active server. Depending on the number of the Active and Redundant servers, if the number of failed servers exceeds the number of Redundant servers, the failover will be abandoned. For example, if 2 Active servers failed, and there is only 1 Redundant server available, the second Active server that failed will be abandoned.



In the event of a server failover, a VSS server in the Redundant group takes over the recording task. Note that depending on the network environment, the takeover can take up to 5 minutes.

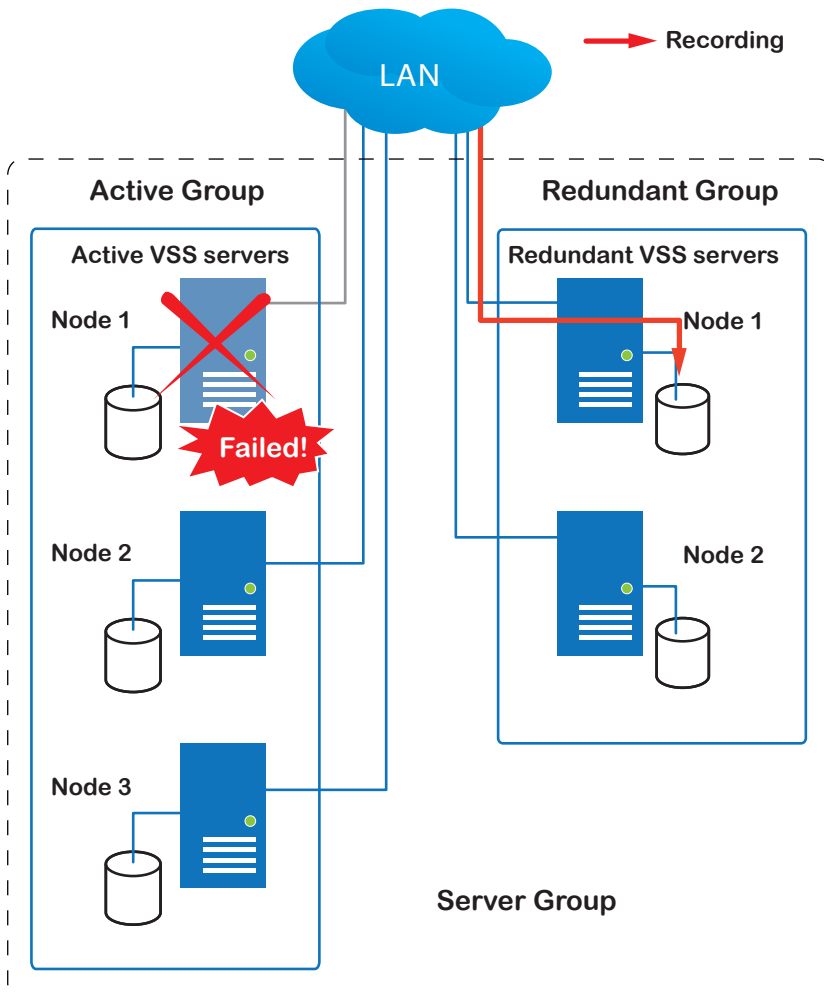

Once the server in the Active group is restored to normal operation, and a CMS server requests for the recordings and data occurred during the time the active server failed, the requests will be fulfilled by a shared volume on the redundant server. Due to the concerns with network bandwidth and processing power, the restored active server does not synchronize its recording pool with that on the redundant server after the failover and failback process.

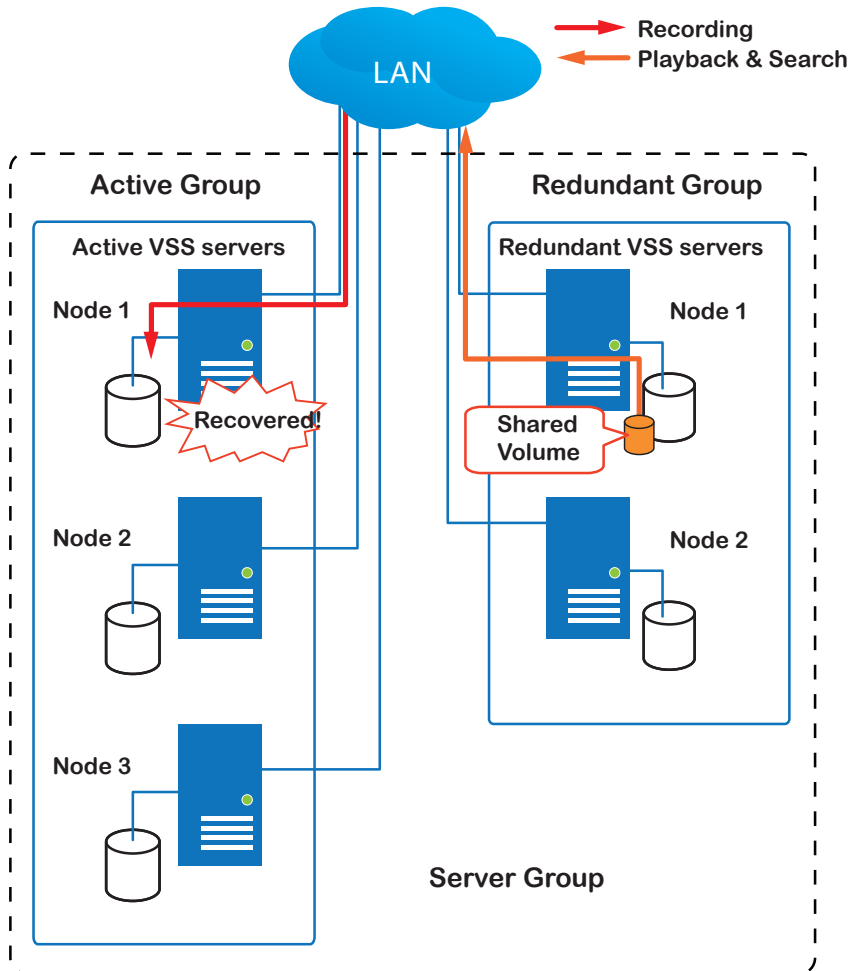

In terms of network failure, the VSS configuration supports Seamless Recording. For cameras equipped with an SD card, video is recorded to the SD cards in the event of network failure. Of course, the cameras must have a backup power source, such as a DC 12V input. In cases such as the only PoE switch or PoE mid-span fails, power is lost.

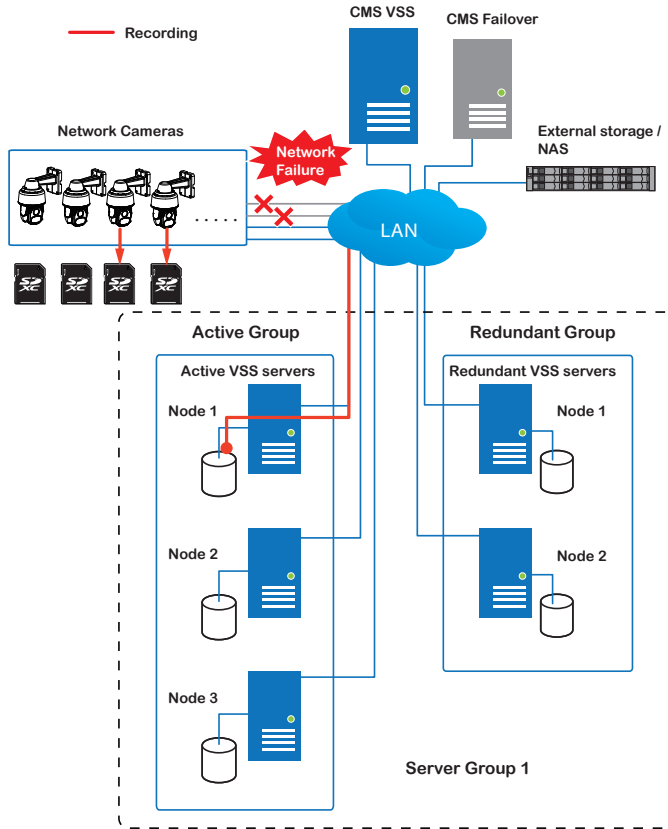

Once the network connection is restored, the VSS servers resume the recording task and also retrieve video segments from the SD cards. The video segments recorded during the network failure will be stitched up with those occurred before and after the network failure. The retrieval speed varies depending on the available network bandwidth and CPU resources.

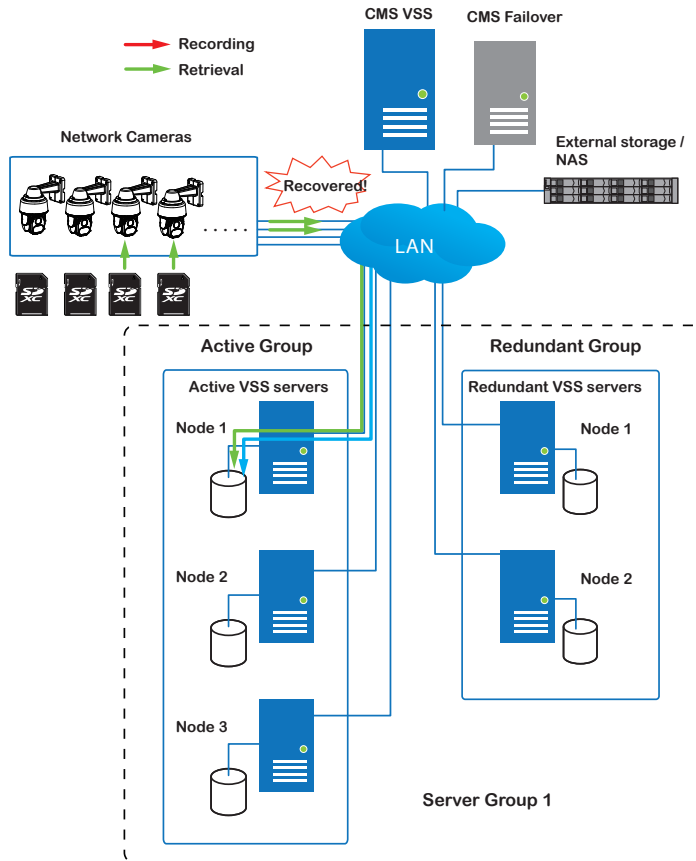

Failover Configuration Process

Before Failover configuration, you need to add other servers to your Failover configuration. Below is a screen from the Stations management window.

- If you are adding a Redundant server, select the "Add as a redundant server" checkbox, for either a **CMS** server or **VSS Substations**.
- If you are adding a server without selecting this checkbox, it will be considered as an **Active** server.
- When adding a Redundant server, you can provide a Windows account 802.1x domain user name and password. A Redundant server requires this because a full access to the recorded data is required during the failover and failback process.

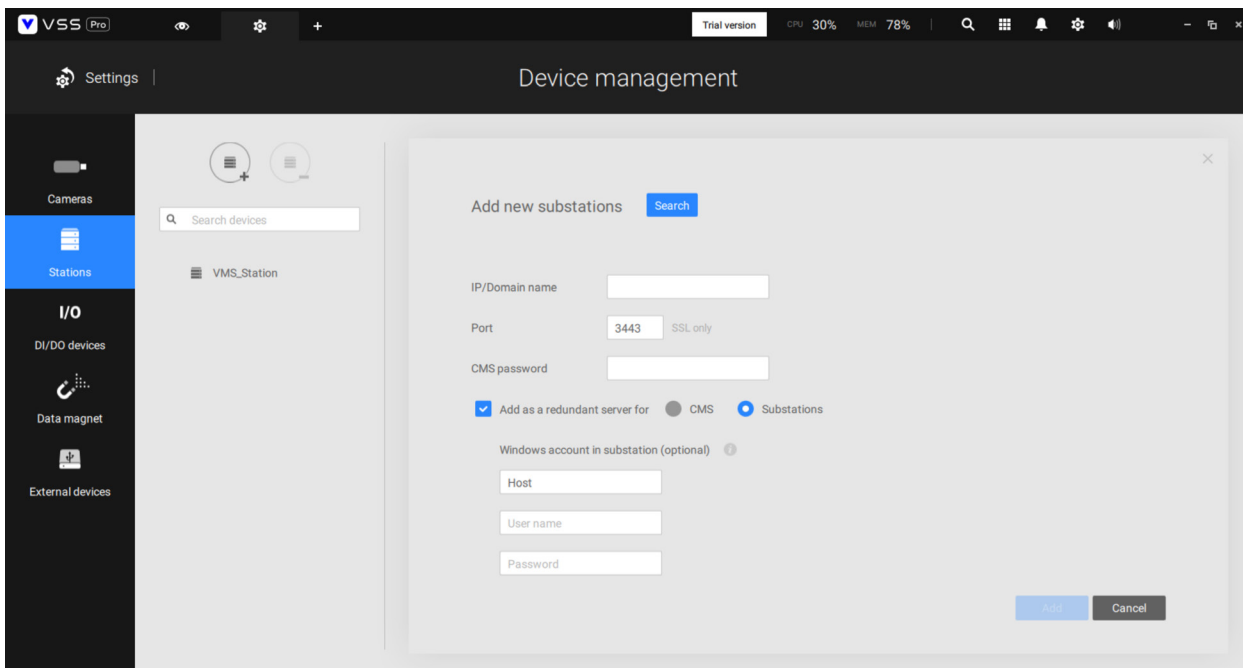

When the "Add as a redundant server" checkbox is selected, enter the name of your Windows domain and the user credentials for a full access to the Redundant server.

The screenshot shows a web interface titled "Device management". Under the heading "Add new substations", there is a "Search" button. Below this are several input fields: "IP/Domain name", "Port" (with "3443" entered and "SSL only" as a label), and "CMS password". There are three radio buttons: "Add as a redundant server for" (checked), "CMS", and "Substations". Below these are three more input fields labeled "Host", "User name", and "Password". At the bottom right, there are "Add" and "Cancel" buttons.

Note that it is a must for the Redundant server to be installed differently by selecting a "Redundant server" checkbox during the installation process.

The screenshot shows a window titled "VAST Security Station". Inside, there is a section titled "Select a server". There are two radio buttons: "Standard server" (selected) and "Redundant server" (unselected). Below the "Standard server" option, there is a note: "The 60-day trial starts automatically when the installation is complete. If there is an existing license on this device, the license will be used after installation." At the bottom, there are three buttons: "< Back", "Next >" (highlighted with a blue border), and "Cancel".



When a Redundant server is successfully added, the server will be listed under your VMS station.

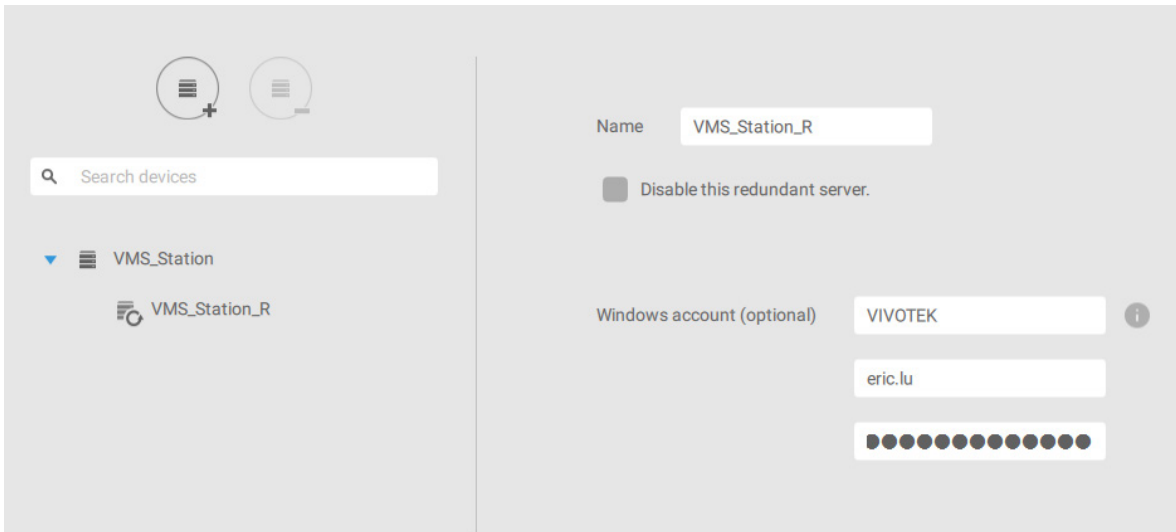

A Redundant server comes with an associated icon, .

An Active server must have a CMS password configured for the hierarchical configuration.

Note that on the Active servers, you should configure them as the subordinates to your CMS VSS server. On a web console to these servers, open the Station management page, and select "Allow CMS to access this station." Create a common password for the CMS hierarchy.

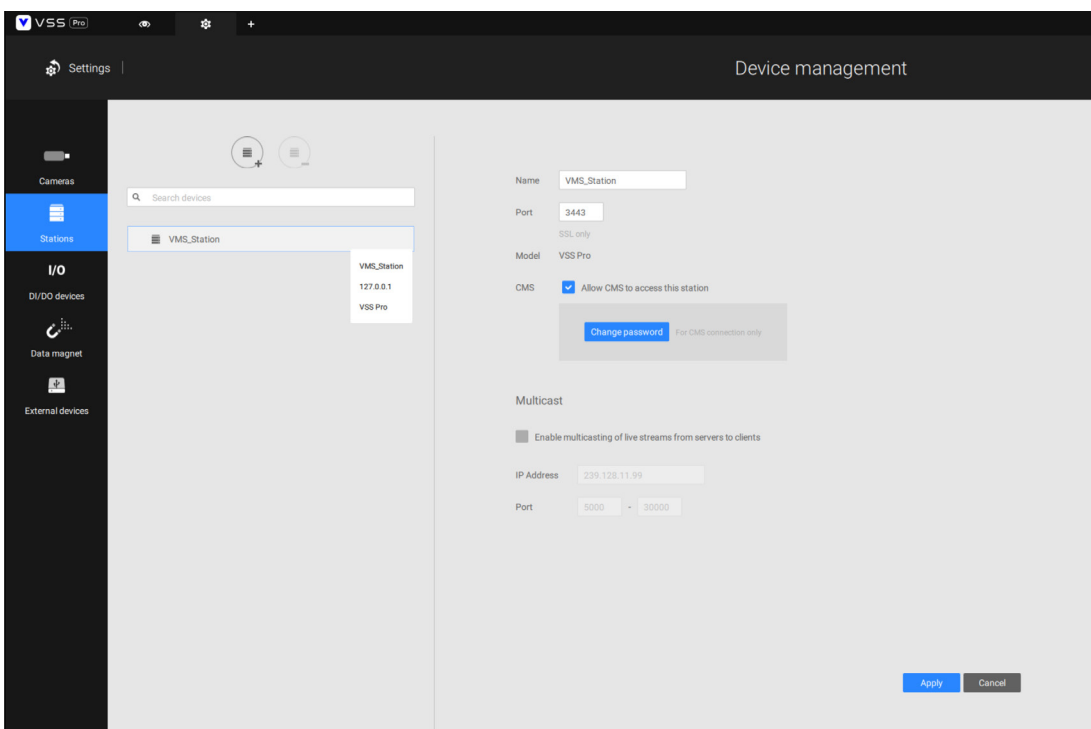



Two agents will be running on the Active and Redundant servers, "stunnel" and "VMSWebServer."

Make sure they are not blocked out by your firewall. These agents can be found in the default folders below:

C:\Program Files (x86)\VIVOTEK Inc\Tunnel\stunnel.exe

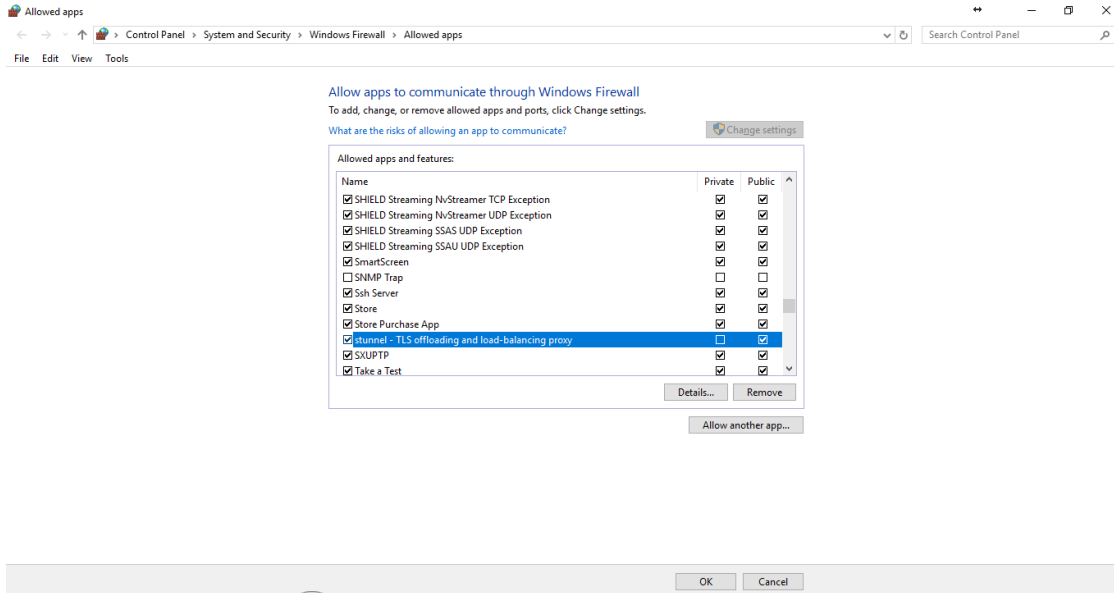
C:\Program Files (x86)\VIVOTEK Inc\VAST\Server\VMSWebServer.exe



Click on the Add  button to create a Redundant server group. The Active and Redundant servers you enlisted on the Stations page should all be listed below. Select the members of the Redundant group, and click Add to complete.

The default for the network disconnection timeout is 30 seconds. It is not recommended to configure a very short timeout, e.g., 5 seconds, because if doing so, a temporary network disorder can make servers consider the Active server(s) have failed.

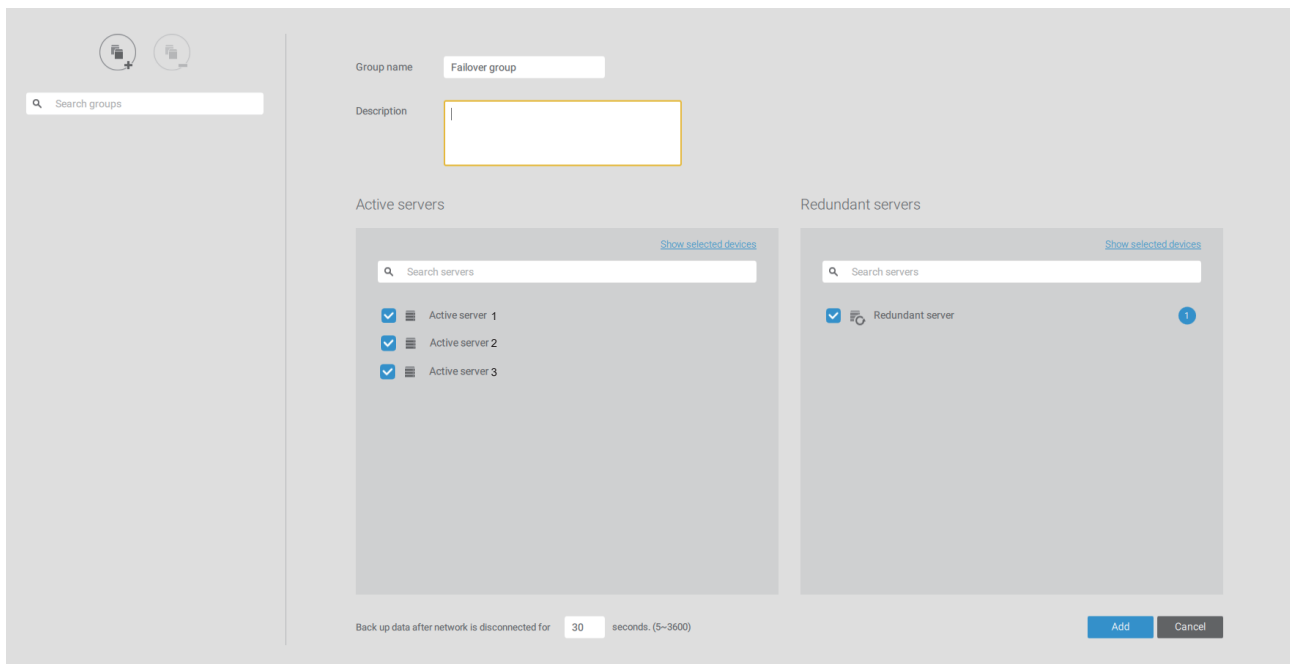

3-3. Counting Report

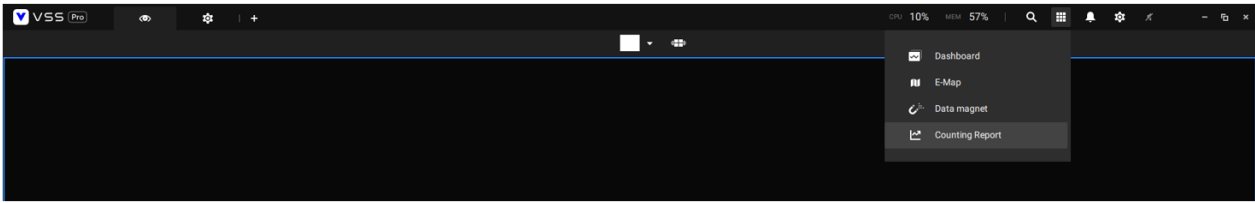

The Counting Report utility is started from the tool bar on top. The Counting Report utility provides comprehensive graphs and line charts for quick access to the data collected through VIVOTEK's People Counting modules, such as the SC8131 stereo camera. Statistical results is refreshed by hour or minutes, and you can compare the results acquired through different time periods or among different surveillance areas. These data help figuring the customer flow in retails so that shop owners can optimize the arrangement of store layout, or manage queues more efficiently.

Note that the configuration of detection methods in People Counting still occurs on a web console to individual cameras. It is not configurable through the VSS LiveClient.



Prerequisites:

The prerequisites for using the Counting Report are:

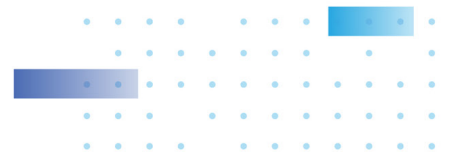
1. The monitoring server running the Counting Report utility must be up and running during the time the counting VCA is taking place. If you power off the server, the counting metadata generated during the server down time will not be available for analysis. The VSS server instance runs in the background. The VSS management console does not need to be started during the Counting Report data collection process.
2. Cameras running the VCA utilities have been configured and added into the VSS deployment. The instances of available VCA rules will be listed in the Area panel.
3. The life expectancy of VCA records is 5 years.
4. Currently the utility supports Windows XP, 7, 8, and 10.
5. The latest revision VSS supports Seamless Recording, in order to retrieve collected data and recording during Ethernet disconnection. Provided that an SD card is installed on the VCA-enabled cameras, the VSS station gradually retrieves data from the SD card after the connection is restored.



To start Counting Report:

1. Click on Counting Report  button on the tool bar.
2. Select People Counting.
3. Click on the Add area  button.

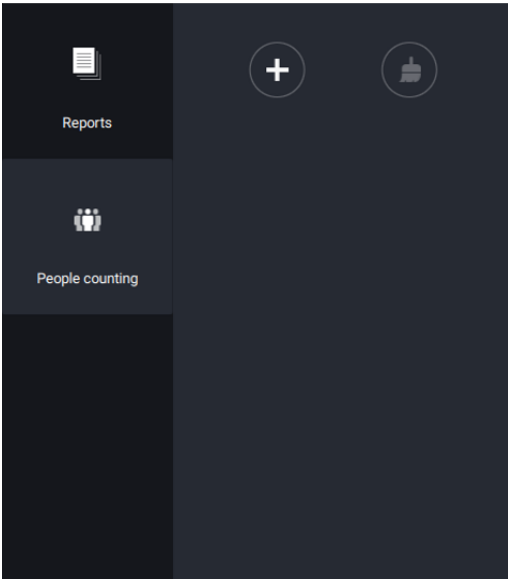

4. Select a camera that is VCA-enabled, and then click the Create button.

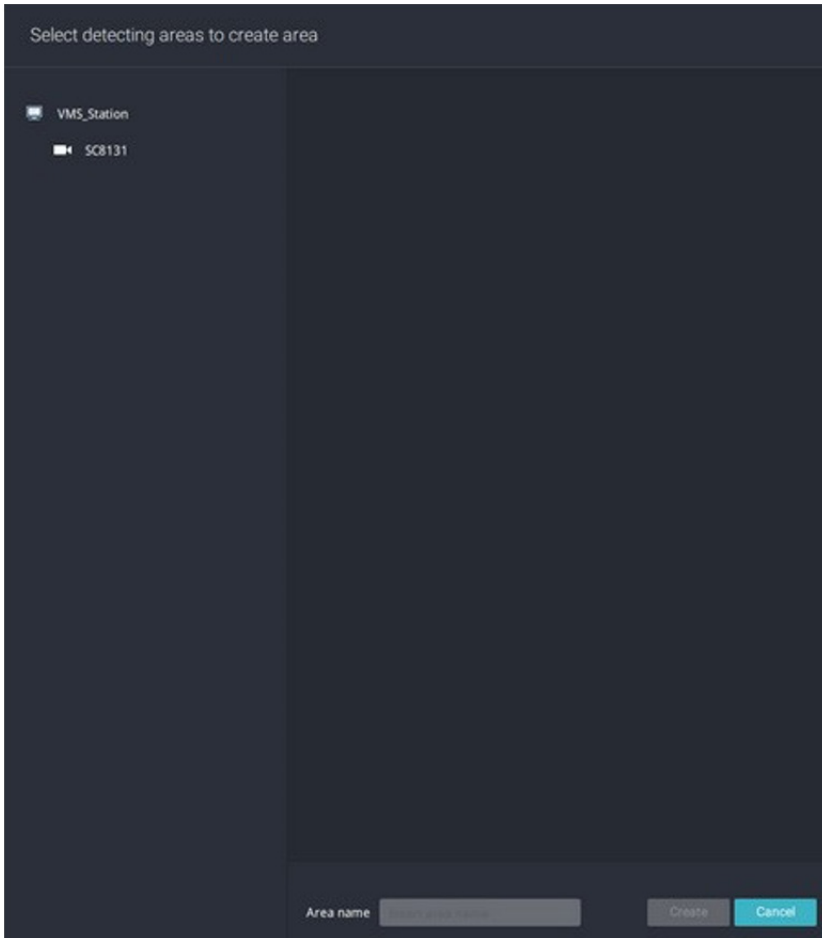

- The pre-configured counting rules (areas) will automatically display. Select a counting rule and enter a name for the area. When done, click the Create button. If only one camera is selected, its name will apply as the Area name. If not, enter a name for the area.

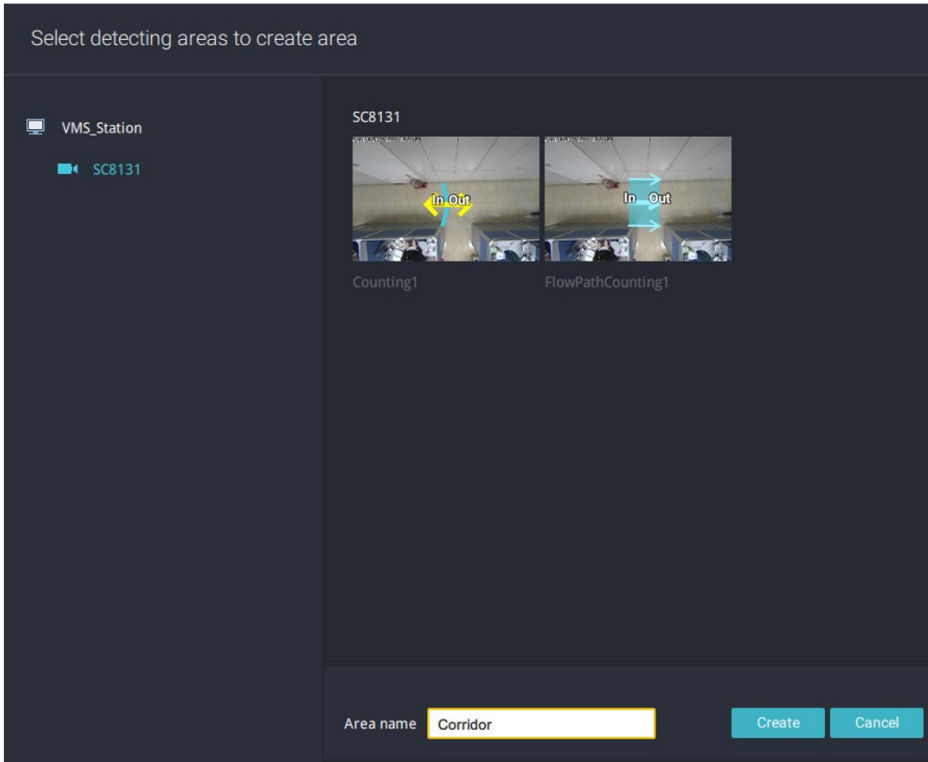

- Click to select one or multiple areas. Those selected will be highlighted in a different color.

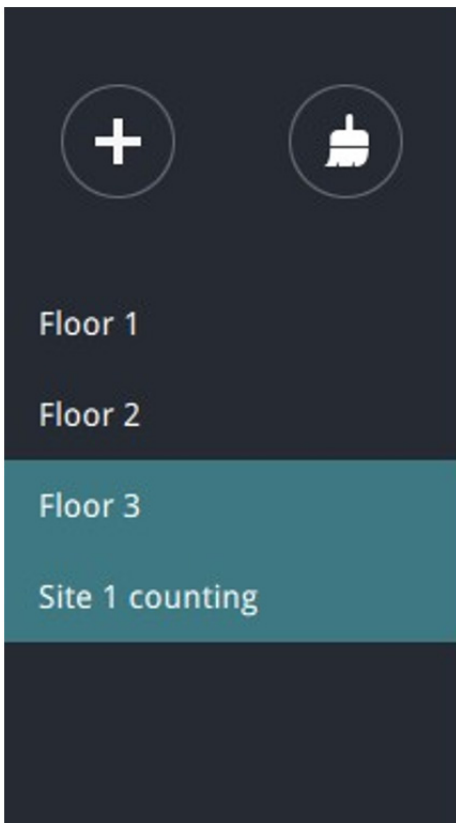

7. Select Date & Time

7-1. By default, the time displayed on the calendar is the current system time on the client computer running the utility. Select from the Date selector  on top.

7-2. Select a date or span of time from the calendar or use the Time  selector to select a span of time.

- > Single-click to select a date or click and drag to select multiple dates.
- > You can select a month or a year using a single click. If you select a month, the timeline unit will be days within the month. If you select a year, the timeline units will be the months in a year.
- > In the Month or Year panel, single click to select the entire month or an entire year. Double-click to select sub-units, e.g., days within a month. If you double-click on a Month panel, you will enter the Day panel.

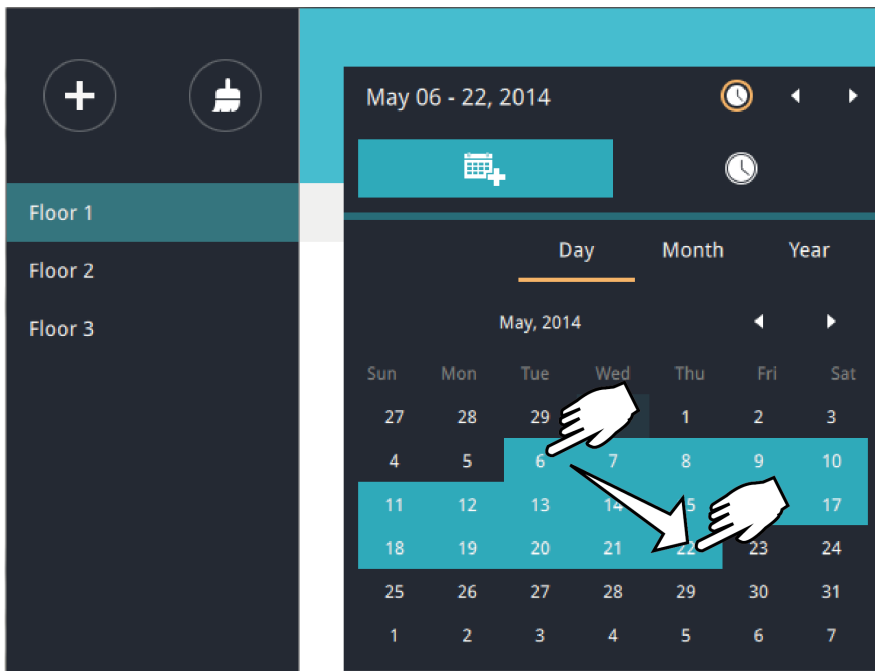

You can select a different month in the Month or Year panels. The Calendar panel disappears if left unattended for 2 seconds.

On a Month panel, double-click to select a month, and the Day panel for that particular month will display.

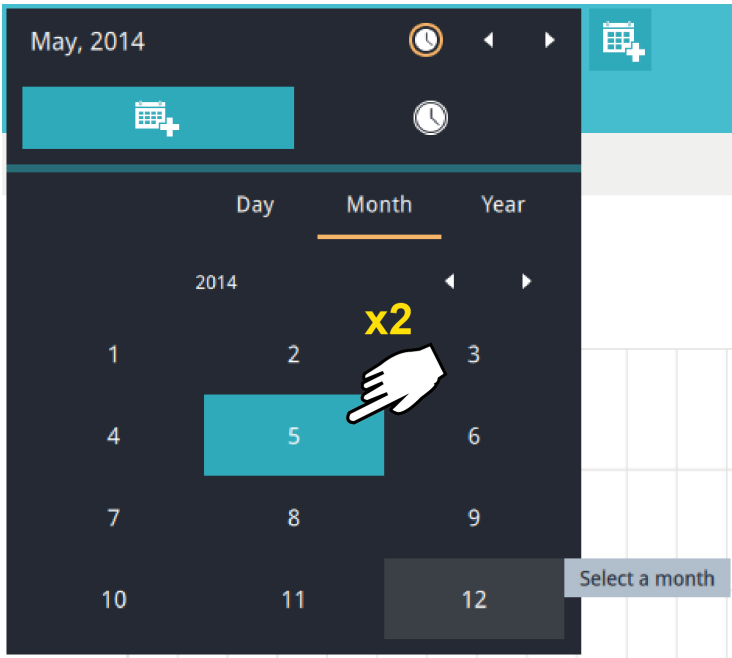

Note the following when making the configuration:

- When a date is selected, the Date and Time panel will not automatically close, and the configuration changes will not take effect until it is closed. You can click on the outside of the panel to leave the panel.
- You can select multiple days to form a span of time. Select one date with a single click and select multiple dates by dragging your cursor across the screen to an end date you prefer.
- To select a year, click to open the Year panel. Single click to select a year. Multiple years can be selected using the click and drag method.



7-3. Select the hours to be included in the statistical poll using multiple clicks on the chart.

Single-click to select an hour or click and drag to select multiple hours.

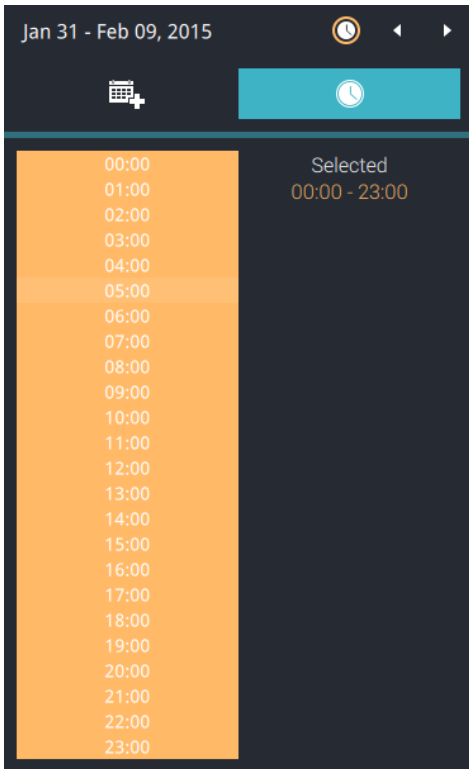

Note that you can only compare the counting results from two spans of time if you select only one Area. If you selected multiple Areas, you can not compare the results from multiple time spans.



7-4. Click outside the Calendar panel. The statistical results will display. The default display is the bar chart. Below is a sample screen showing the results polled from 3 areas. Up to 8 areas can be selected in one view.

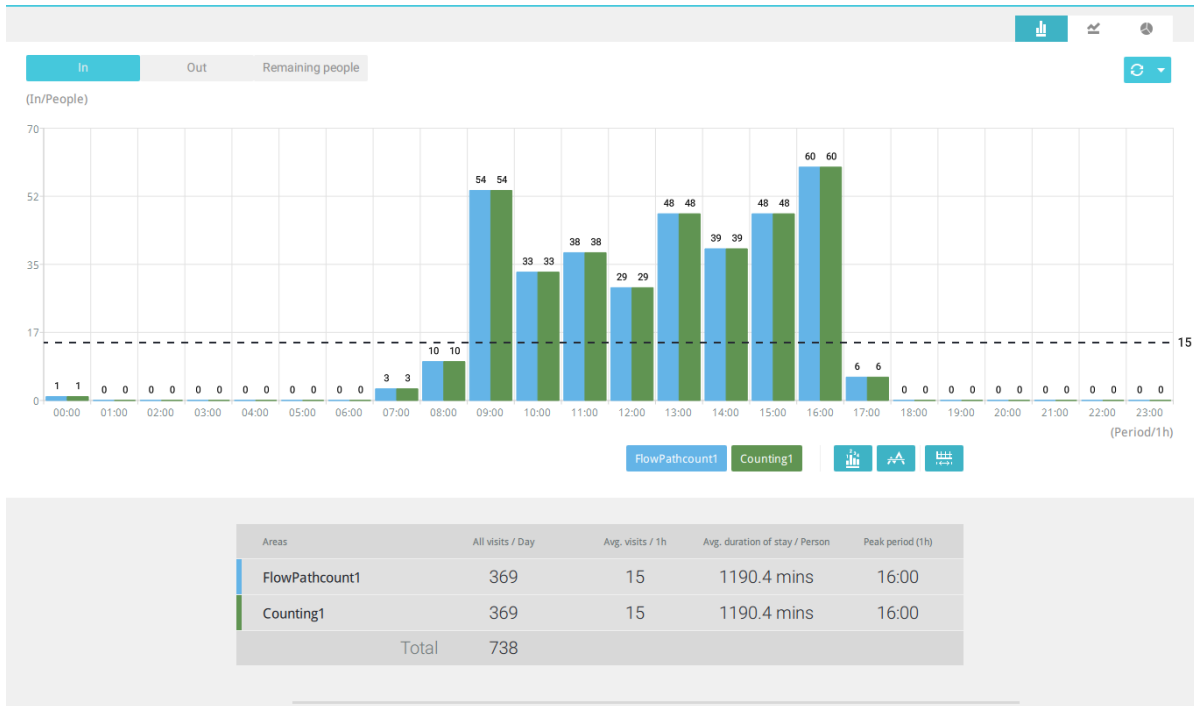

Select different display modes using the Bar  , Line  , or Pie  chart buttons.

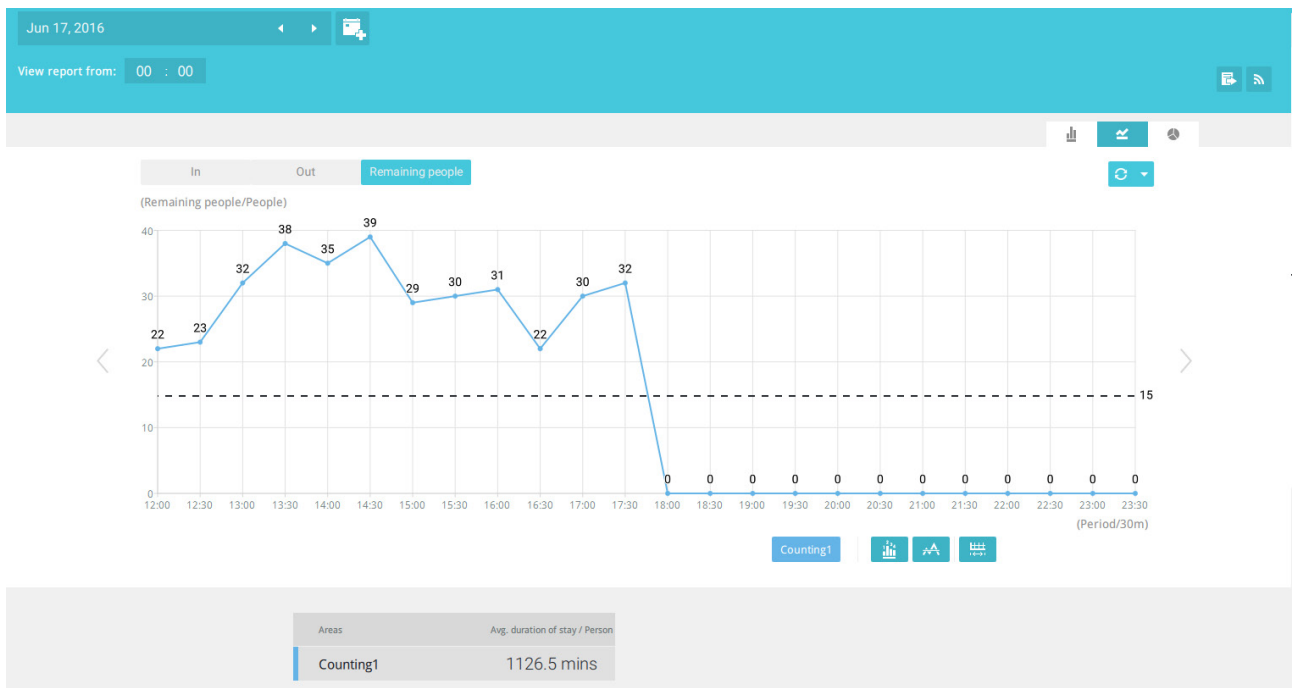

Note that the timeline units can vary depending on the span of time you selected on the Calendar panel. If a date was selected, hourly data will display in chart. If a year was selected, monthly data will display in chart.

Use the following functional buttons to change the display parameters

Show data on chart  : Displays the collected numbers on chart.

Average  : Displays the average number per time span unit (e.g., per hour). If the interval is changed to 30 mins, the average number will be halved comparing to the number acquired by every hour.

Report Interval  : Configure the intervals for polling data from the camera. The default for displaying results is by every hour. If you enter 30 minutes as the display interval, all data will be listed on the basis of the 30 minutes time span. The configurable range is 1 to 1440 mins.

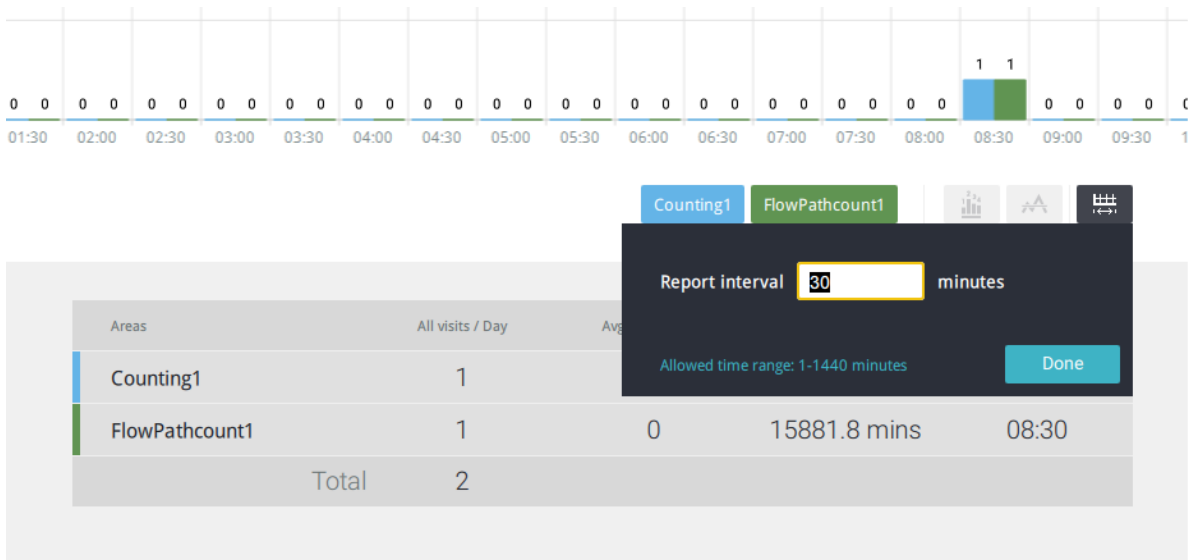

You can use the update menu on the side of the Refresh button to determine an automatic update schedule. You can let the statistic chart update itself by a regular interval.

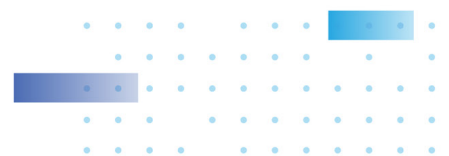
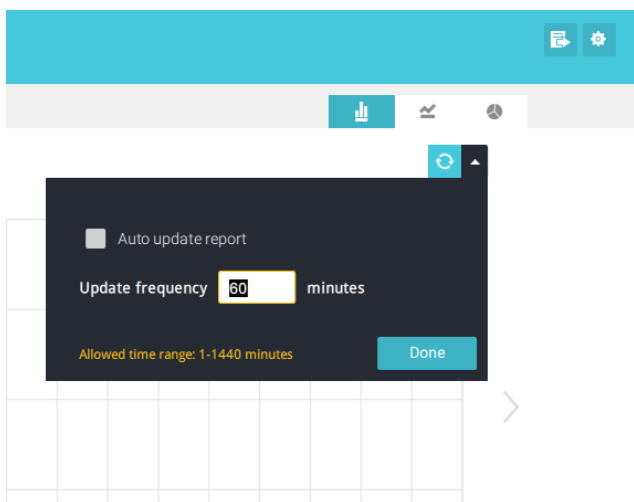

If you selected only one area, you can use the Shift key to select multiple areas (or two spans of time). You can select multiple dates in the Calendar panel.

Use the Refresh button  to poll the latest data from camera.



Use the time selector on the View Report from pane to select the start time of your statistics view window. Data collected before that time will not be displayed.

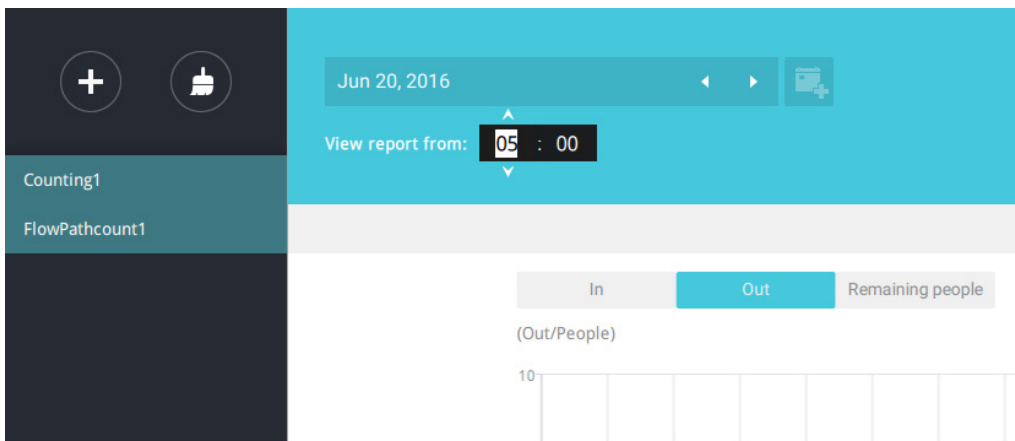

A number is displayed when you mouse over an area on the chart. Move your cursor to an area on chart, and the number is displayed.

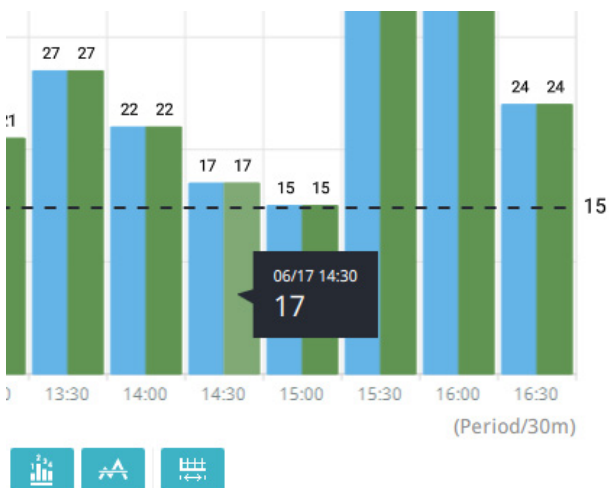

Data on a time line will be generated. To close the window, use the close button on the second date information. Equivalent spans of time can also be used for comparison. For example, you can compare the data in a span of 4 days against another span of 4 days.

Note that the Compare function only applies when you select to display only one area on the screen.

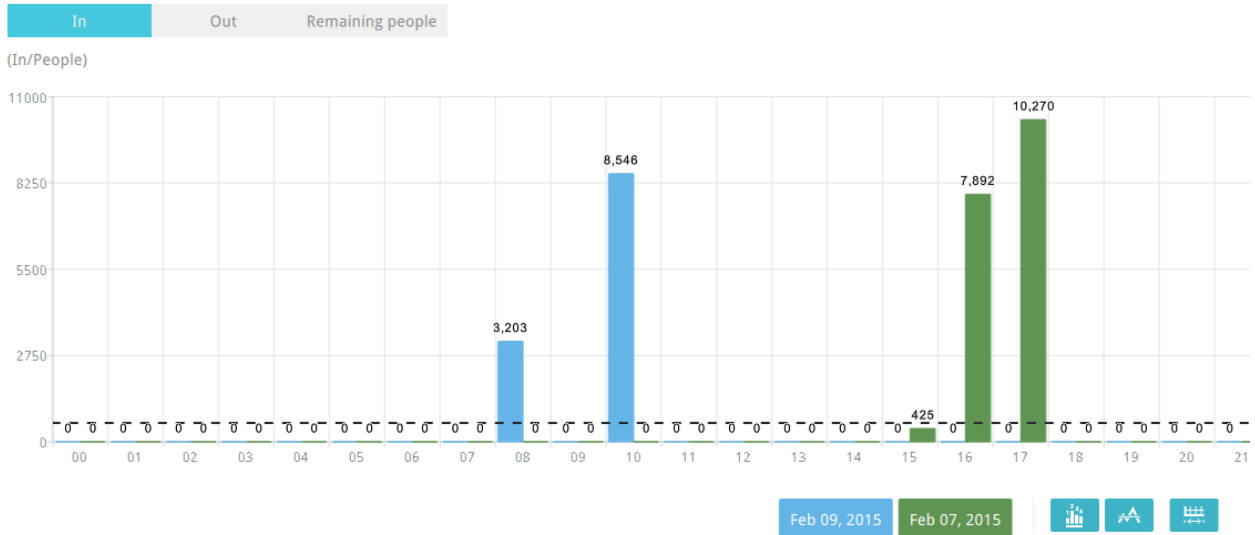

In a comparison result displayed in a line chart, mouse over to the peak value to display the percentage of an increase or decrease rate.

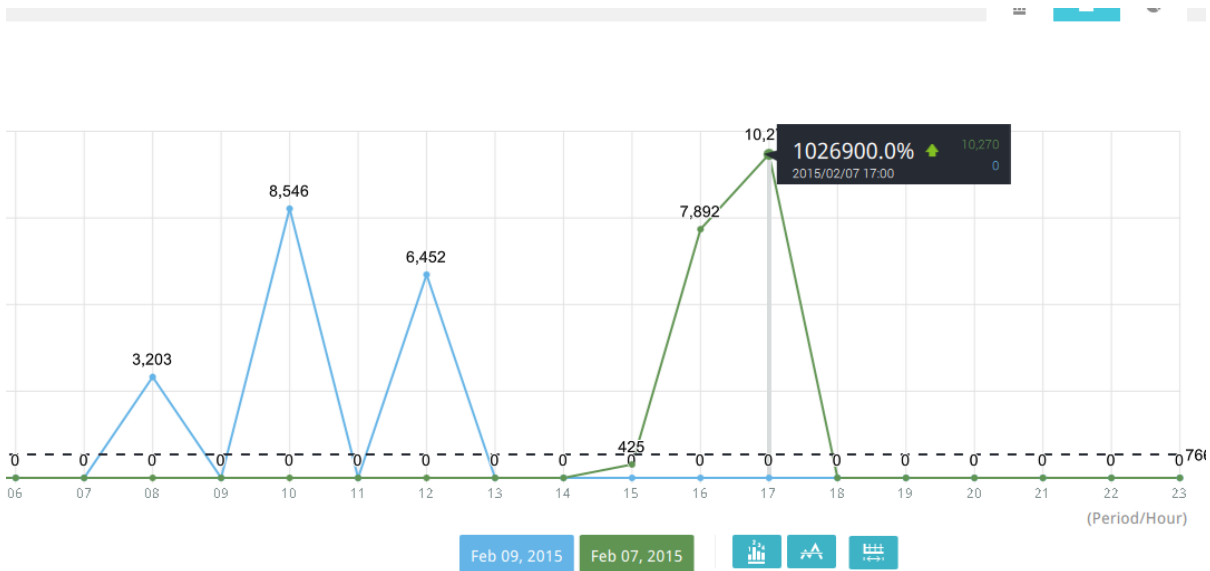

See below for the functions of buttons on screen.

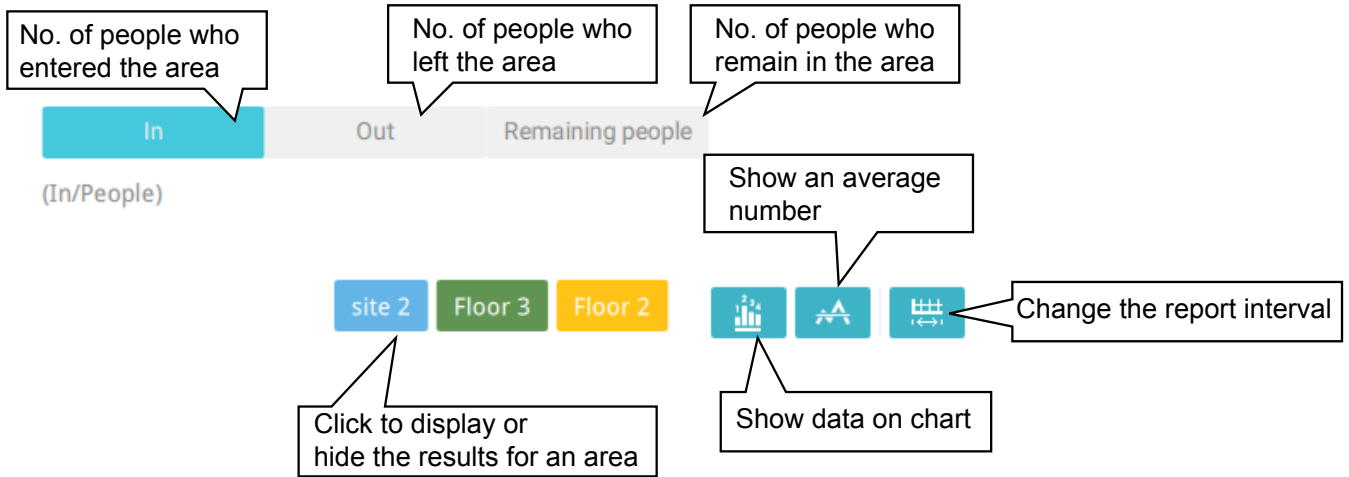

In addition to the charts, a summary of displayed data will be listed below showing the areas involved, visits/Day or Month, Average visits / Hours / Days, Average duration of stay / person, and the Peak hour.

Areas	All visits / 4 days	Avg. visits / Day	Avg. duration of stay / Person	Peak day
Floor 3	490,870	122,718	106.3 mins	12/04
Floor 2	959,482	239,870	105.9 mins	12/02
site 2	3,873,510	968,378	108.0 mins	12/01
Total	5,323,862			

8. When done with displaying the results, you can use the **Export**  button to produce an image file to preserve the current results. Both a spreadsheet and a graphic chart will be produced.

By default, the exported report is placed in:

C:\Users\Public\Documents\VIVOTEK Inc\VAST\Client\VCAReport

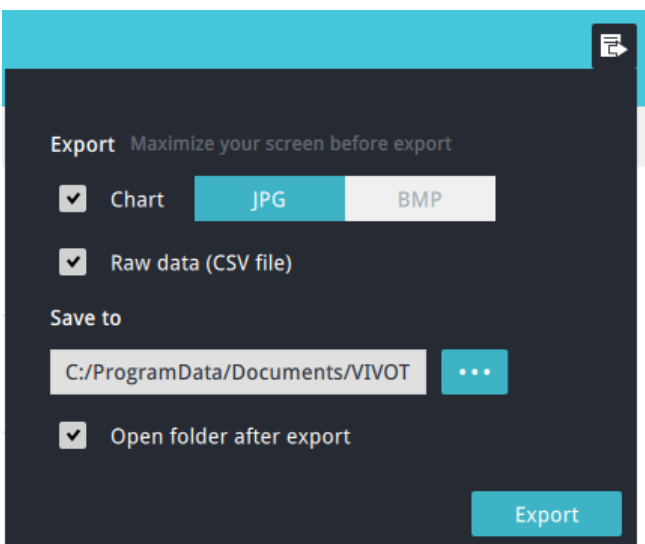

9. Click the Reports Subscription button to configure the regular report sent to your Email account or a specific location on the server itself.

Select the following:

1.	Report type: People counting results, or Heatmap (Heatmap does not produce the CSV file)
2.	Area: All areas or a preconfigured area.
3.	Subscribe: Enter the sender and recipient Email addresses. You can also configure to send the report to a specific location on the server.
4.	Attachment: Select to attach graph Charts in JPG or PNG, and the CSV data files.
5.	Time frame: Select the time coverage of the report, during which data is collected.
6.	Frequency: Specifies when and how frequently to deliver the reports.

Select the time to deliver your mail notification. Enter valid Email addresses as the sender and receiver addresses and make sure the SMTP mail server configuration has been properly configured on your VSS server. This VCA mail notification utilizes the mail service on VSS for regular notification. You can then receive Email notification every day on your Email account. You can enter up to 5 recipient addresses.

Select the report interval to determine how often you receive an aggregated report.

Add report

Report name

Report type People counting

Area All areas

Subscribe Email

Sender Sender's email

Recipient

Send to server

Attachment Chart

CSV

Time frame Specify time frame for reports

Start time ~ End time (The next day)

Frequency Everyday at Next delivery 2018/03/14 00:00:00

Report interval minutes (10-1440)

Weekly at

Monthly at

Note that the notification contents is your current field of view, including a Bar, Line, and Pie chart combined into one image file. The In/Out/Remaining results will be generated into 3 charts. Each Area will generate one CSV file, and each CSV data file will contain In/Out/Remaining/Summary information.

The generated file names will look like this: 20160226_test02_Remain.jpg for charts and 20160226_Summary.csv for CSV files. The Email subject will be "VCA Daily Report - 2016/02/26."

Note that if you manually export a report, the default is sending the data collected until one hour before the manual export. For example, if you generate the report at 14:07, the report will only cover the data collected until 13:59. You may use the Refresh button to manually generate an immediate data inputs (those occurred between 14:00 and 14:07).

You may configure to receive regular VCA report as Weekly or Monthly using the associated menus.

Below are the messages with the Email test function.

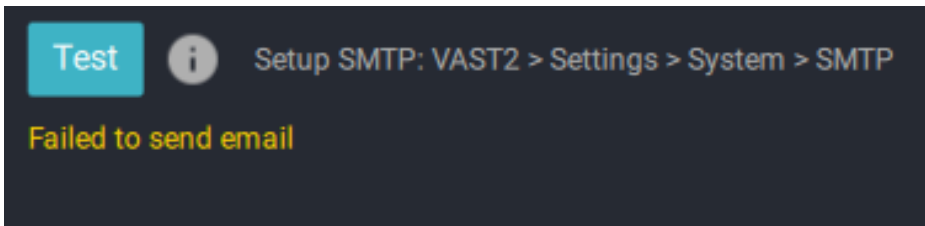

3-4. VSS Software License

To activate the software, refer to the flow chart below:

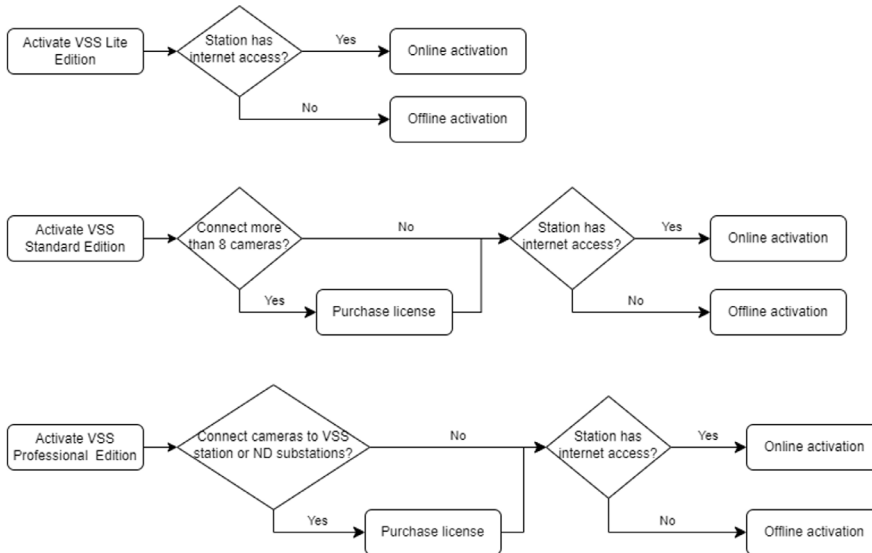

After VSS is installed, a 60-day trial version will be started automatically.

Users must select one VSS edition and activate the license online or offline before the trial expires. Otherwise, the camera live view, playback, and recording services will stop after a 60-day trial. The user can use the edition selector on the VSS website to select the suitable VSS edition and the license calculator on the download page to calculate the required license.

Online activation

If the VSS station has internet access, activate the license using the online activation method. The license request file of the VSS station (.req file) will be sent to the licensing server via the internet automatically. The licensed file (.lic file) will be received from the licensing server if the activation process is successful.

Online activation is recommended over offline activation. However, if online activation fails or internet access is unavailable, see Offline Activation in the next section below.

Steps:



1. The edition menu will show you if you are required to purchase licenses to activate each edition based on your current VSS deployment.



If the purchased license is not required, click on the edition, and the activation process with the licensing server will begin.

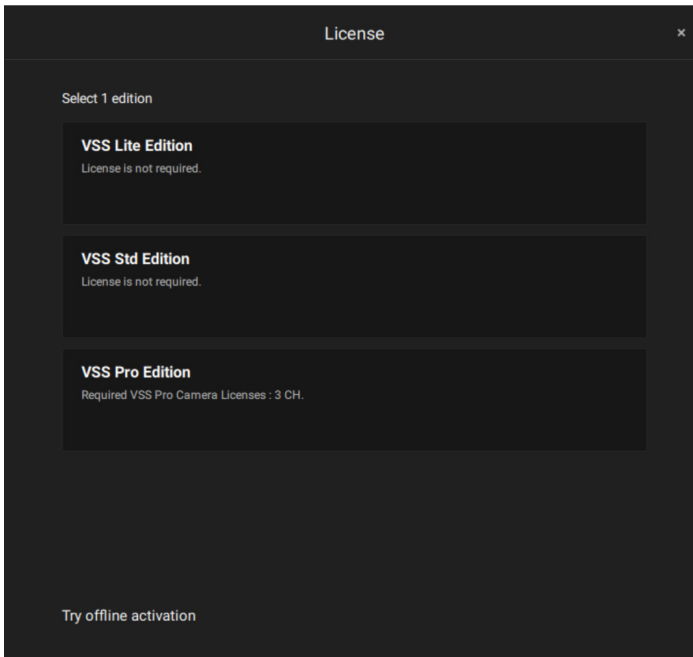

If the purchased license is required, a license key window will pop up after you select the edition. Type in the license key you purchased and acquired from your distributor or VIVOTEK local sales and click Activate, then the activation process with the licensing server will begin.

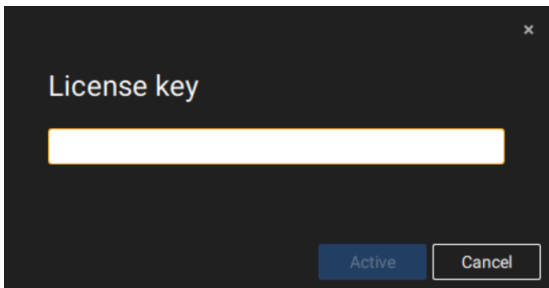

If you select Activate with license key, select the station where the license key will apply to.
Enter the license key.

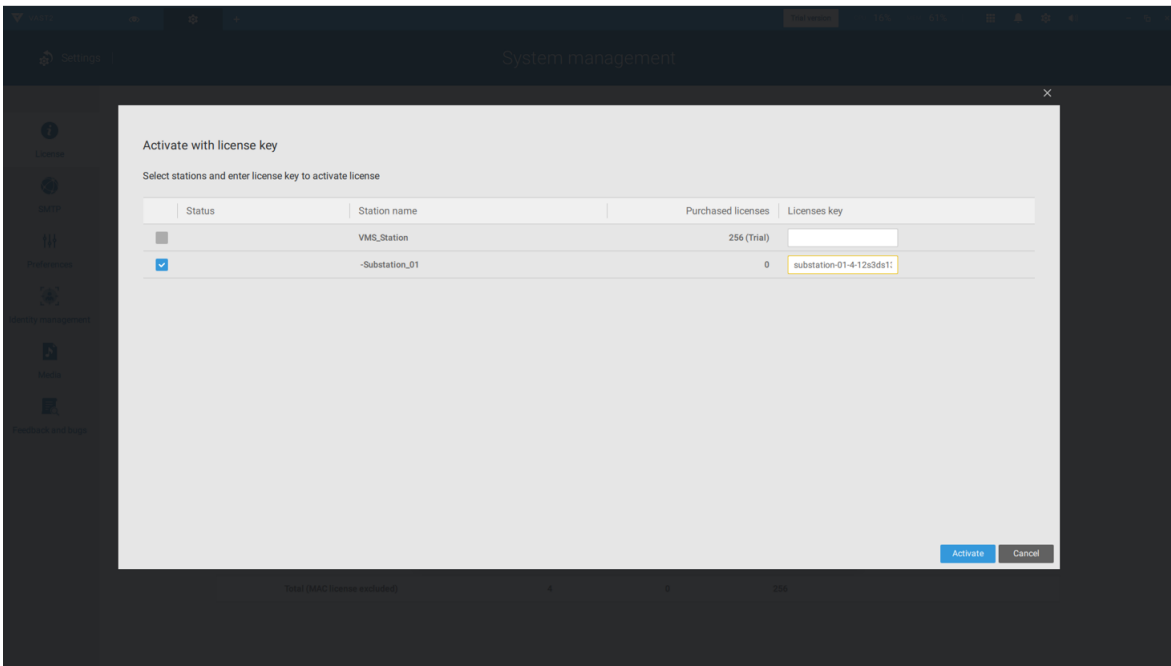

When successfully activated, the associated check circles will turn green. Click the Close button on the upper right of the screen.

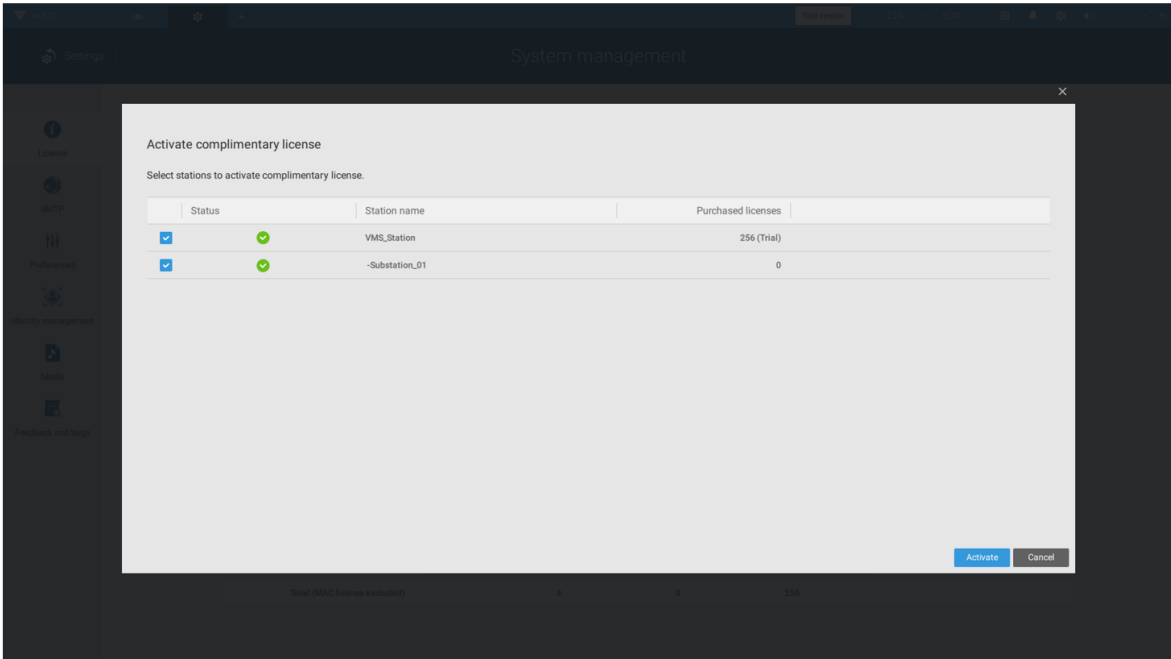

If you fail, status bar will turn yellow with an alarm icon, and the possible reason will be listed.

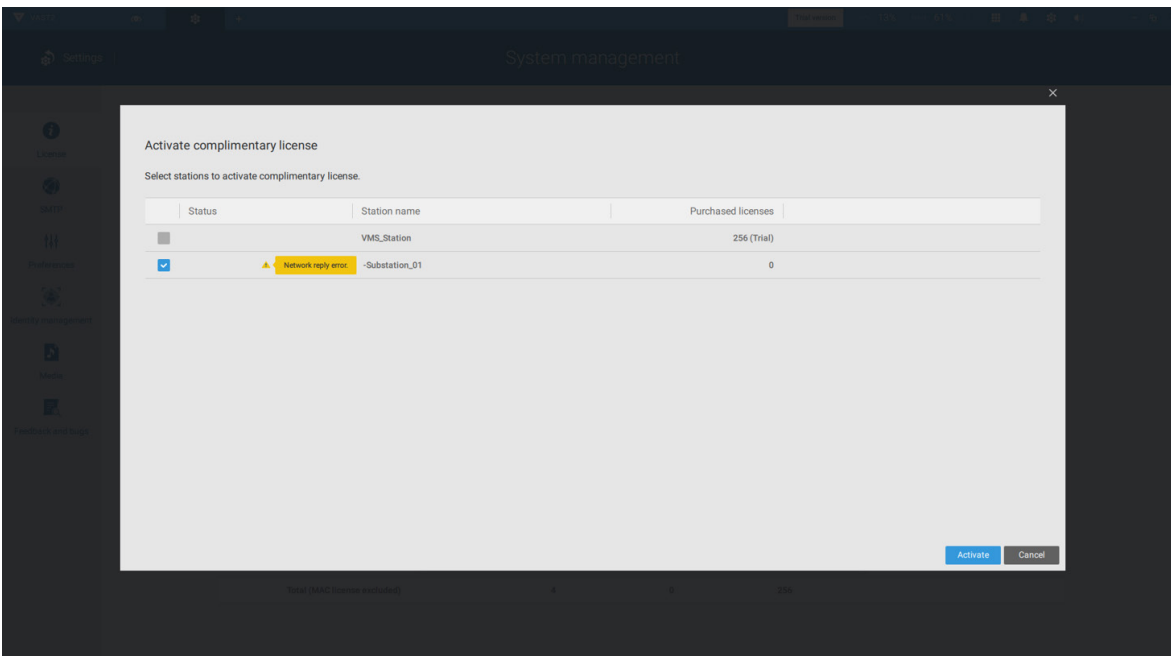

If your VSS station has no Internet connection, Click Try offline activation.

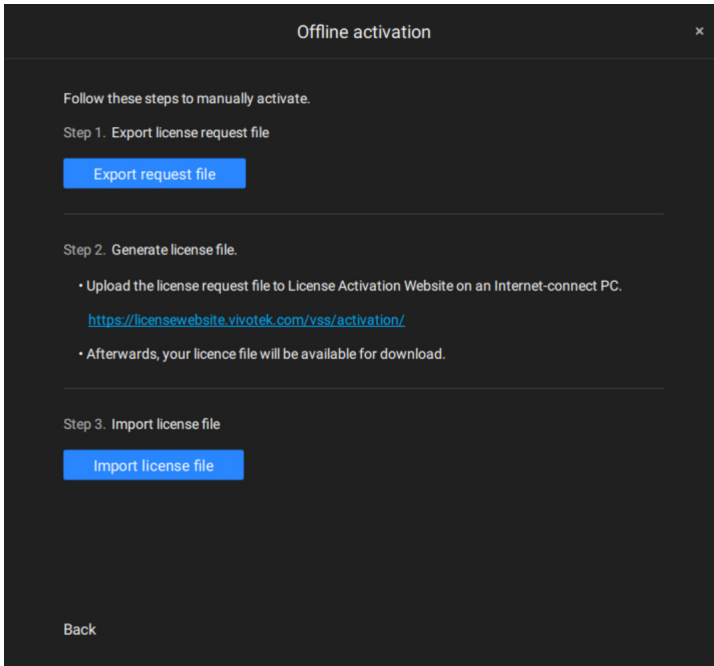

According to the instructions on screen,

1. Export license request file.

2. Select the station to export the license request, click Export, and select the destination of the request file.

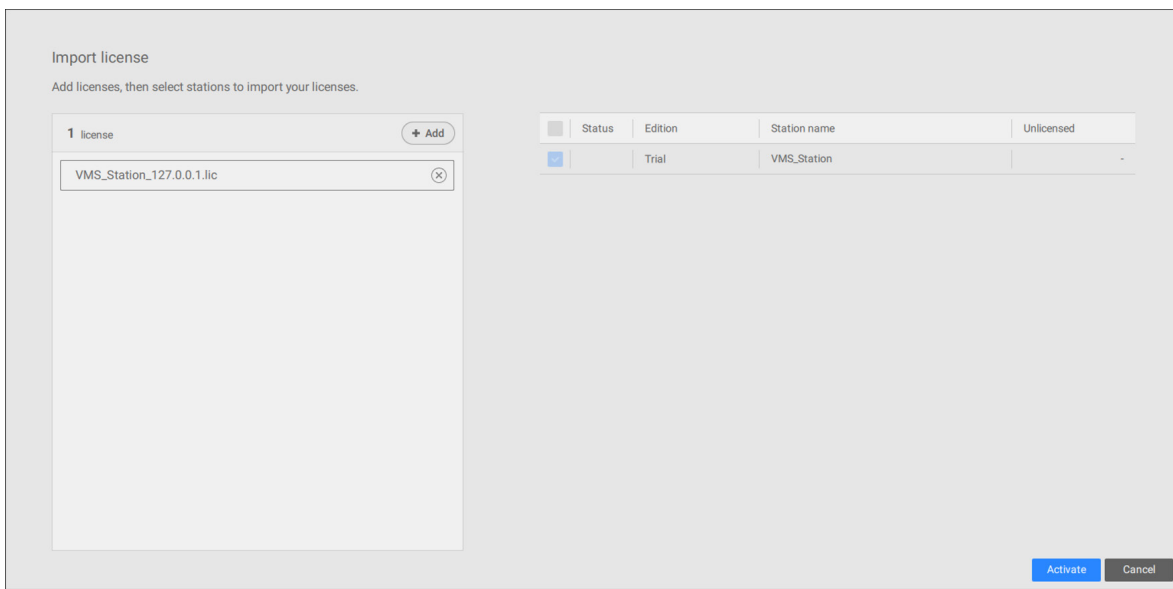

The REQ file looks like the following.

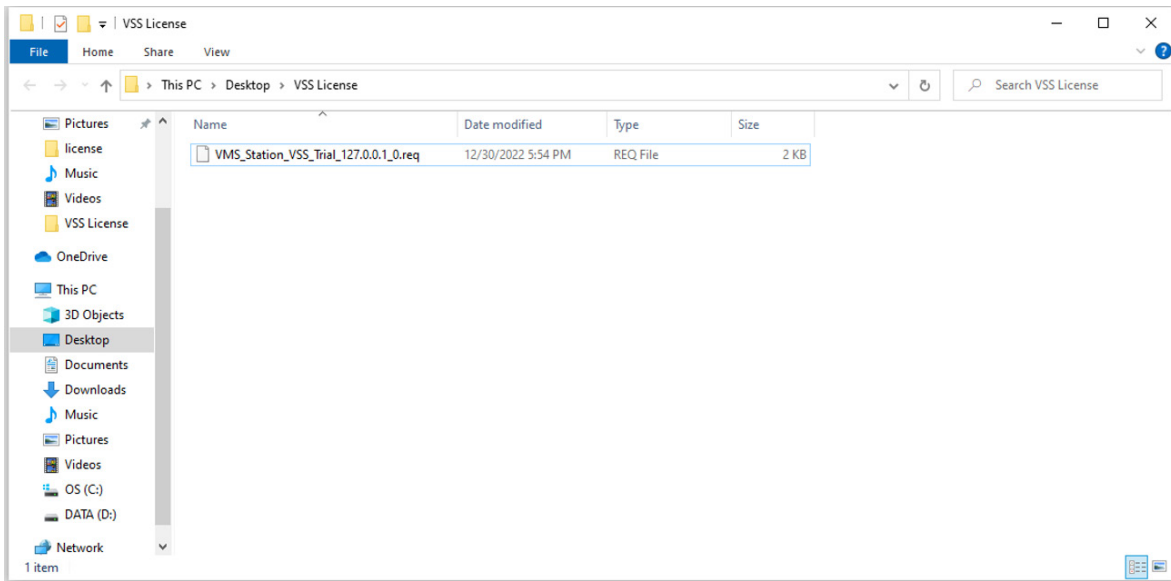

3. Find a computer to upload the license request file (.req) to VIVOTEK's license activation portal at <https://licensewebsite.vivotek.com/vss/activation/>.
4. Follow the instructions on the license activation portal to generate and download the license file (.lic). Upload or copy the file to your VSS station.
5. Go back to the offline activation window on your VSS station, select Import license file, click Add to select the license file (.lic) and click Activate.

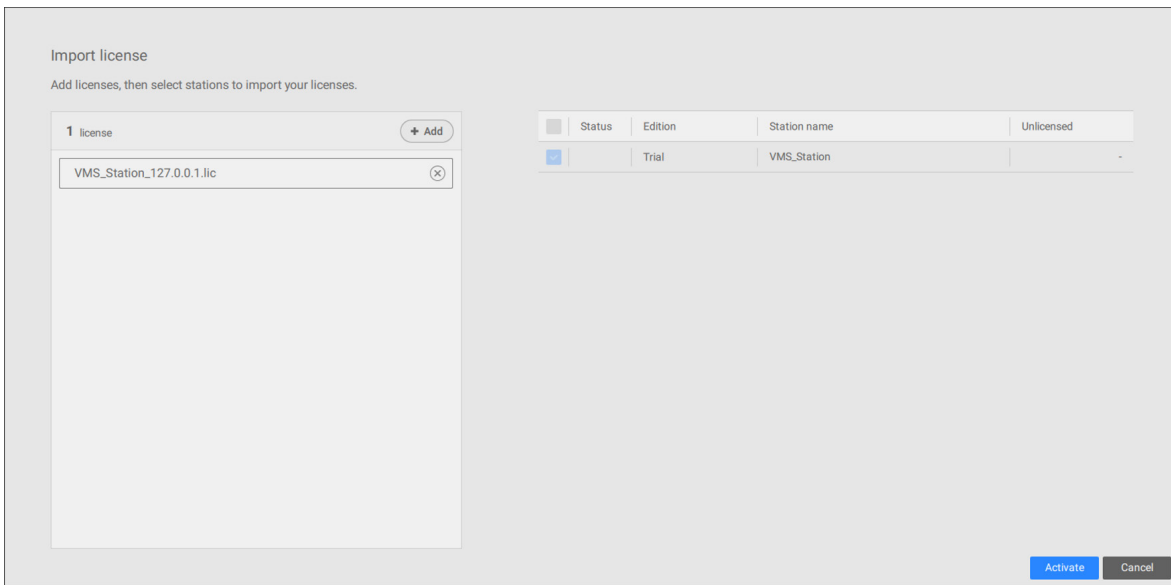

5. On your VSS station, select import license file, click Add to select the license file (.LIC file), and click Activate.

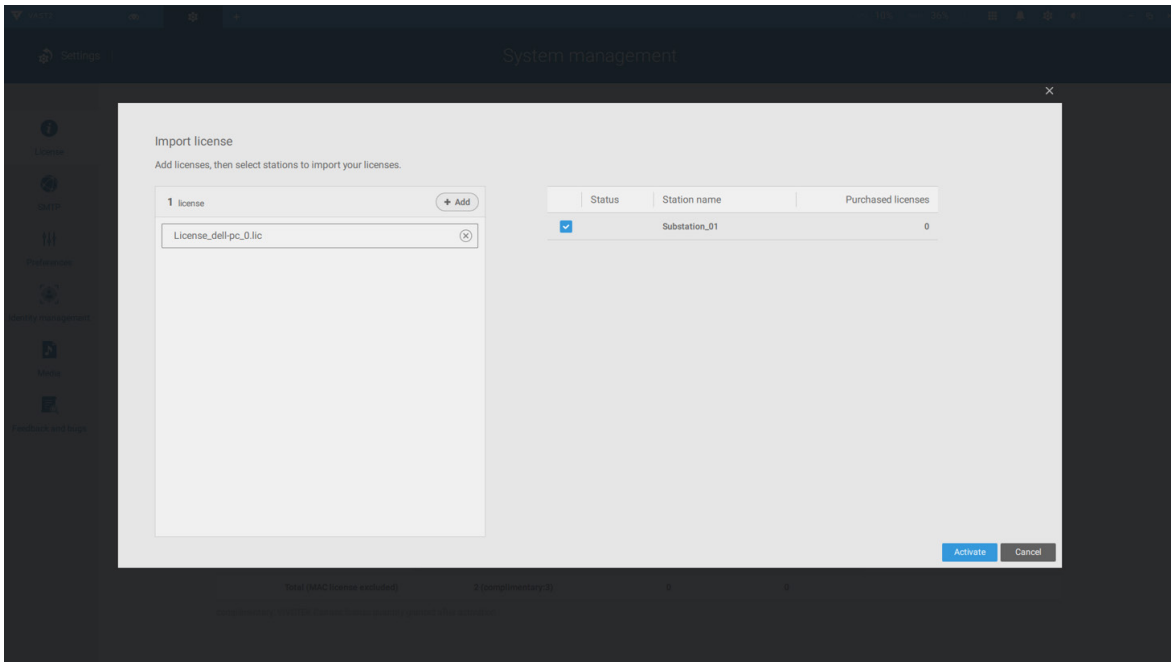

License Protection Mechanisms

The software license is verified by identifying the unique characteristics of the user's PC. The license file contains data on the VSS station's basic hardware configuration (Motherboard, CPU Processor, Graphics Card, RAM, and Network Card). The software license will become invalid if the user changes any three of these essential hardware components.

NOTE:

- Keep a copy of the license key, license request file(.req), and license file (.lic) for future reference.
- Without sufficient licenses, the camera live view, playback, and recording services will stop in 14 days.
- VAST1 license, VAST2 license, and dongle license are incompatible and unable to use as the VSS license.
- An identical software license applies to VIVOTEK and ONVIF cameras. You do not need to activate two different kinds of software licenses.
- If the VSS server application is removed and re-installed, the number of licensed channels remains intact.
- Users can upgrade the VSS edition by activating appropriate edition licenses. Downgrading the edition via the license is not supported.



3-5. Managed PoE Switch

Introduction

Starting from VSS version 1.2, users can integrate VIVOTEK Managed PoE switches as External devices into VSS. This integration allows users to access several functionalities of the PoE switch through VSS, such as controlling the PoE on/off of each port, viewing the topology of the switch connected to cameras, and monitoring the overall network traffic of the switch. This feature assists users in monitoring traffic for cameras through the PoE switch and in conducting basic troubleshooting.

Configuration

Before starting to use the integration features of the Managed PoE Switch, users must first add the PoE Switch to the VSS External device. Users can navigate to Settings > Device > External device > managed PoE switch, click the Add PoE Switch button as shown in Figure 1, and add a new PoE switch. In Figure 2, users can input relevant information about the PoE switch, including the device name, IP address, connection port, login username, and login password. It is important to note that the PoE switch must be in the same network segment as the VSS server to be discovered. Additionally, this integration only supports VIVOTEK brand-managed PoE switches, so please refer to the support list in the datasheet for compatibility details. You can also delete the existing PoE switch by clicking the delete PoE switch button.

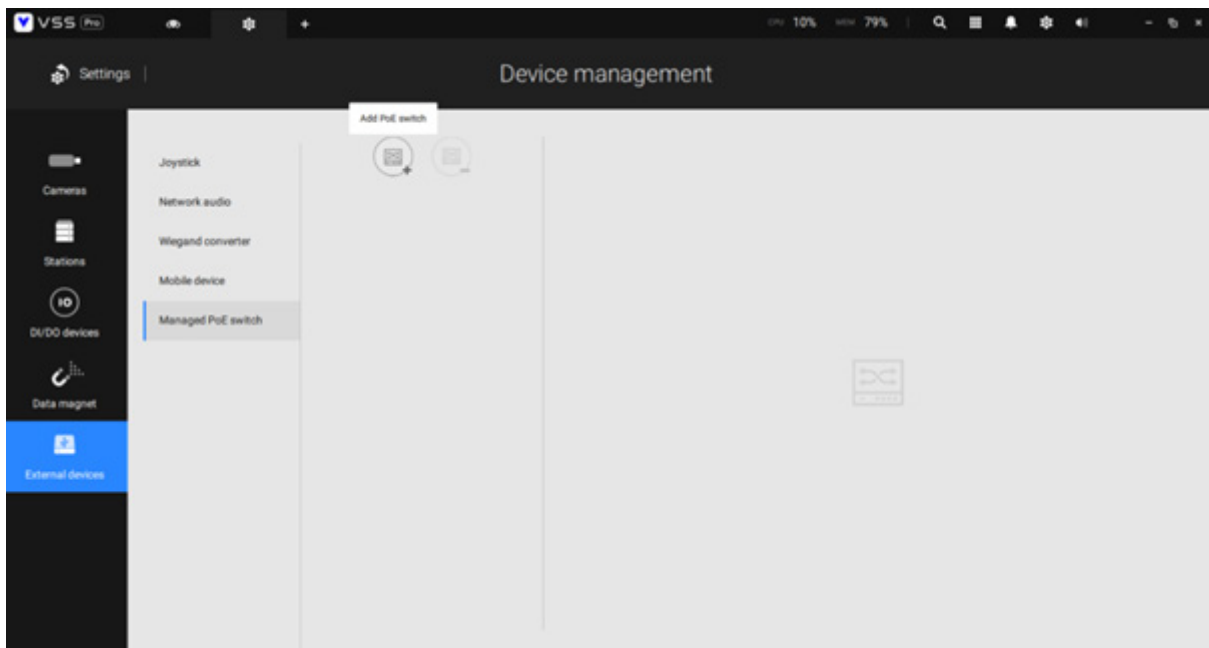

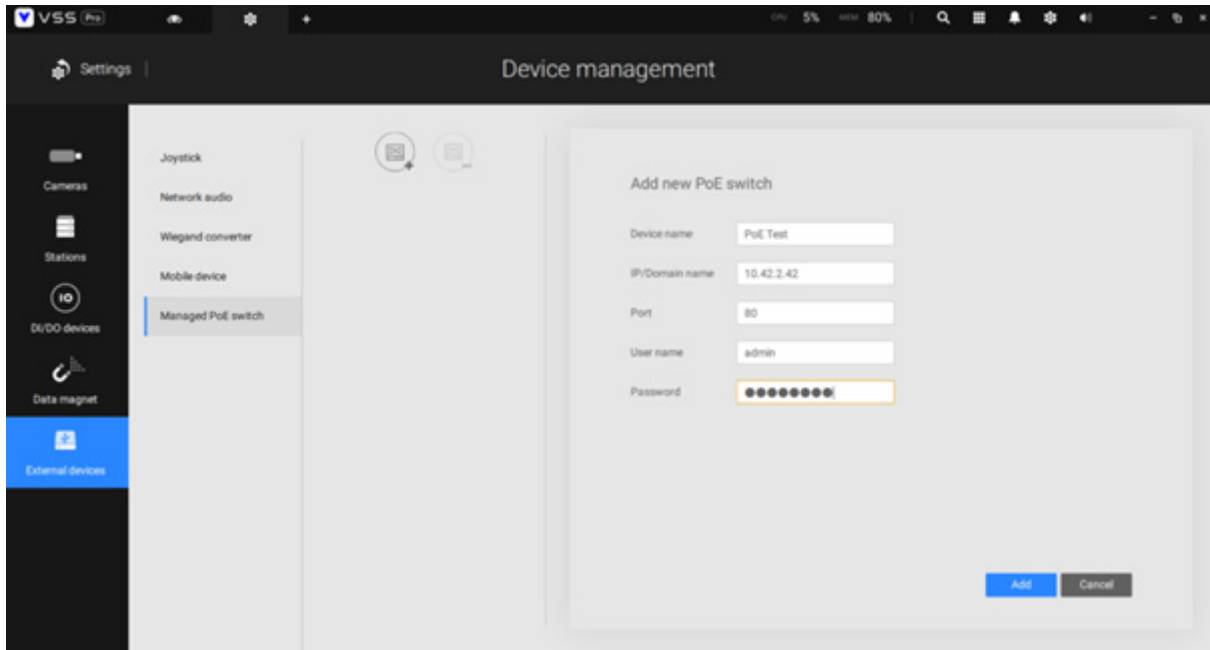

Figure 2

Operation

After adding the PoE switch to VSS, you can click on the PoE switch, and on the right-hand side, you will see the information and related integration web pages for that PoE switch, including PoE on/off, Topology view, and traffic monitor. It is important to note that some VIVOTEK Managed PoE Switches only support the PoE on/off page as shown in Figure 4.

Under the information page, you can see basic information about the PoE switch, including Device name/model name, IP address, MAC address, connection port, and firmware version, as shown in Figure 3.

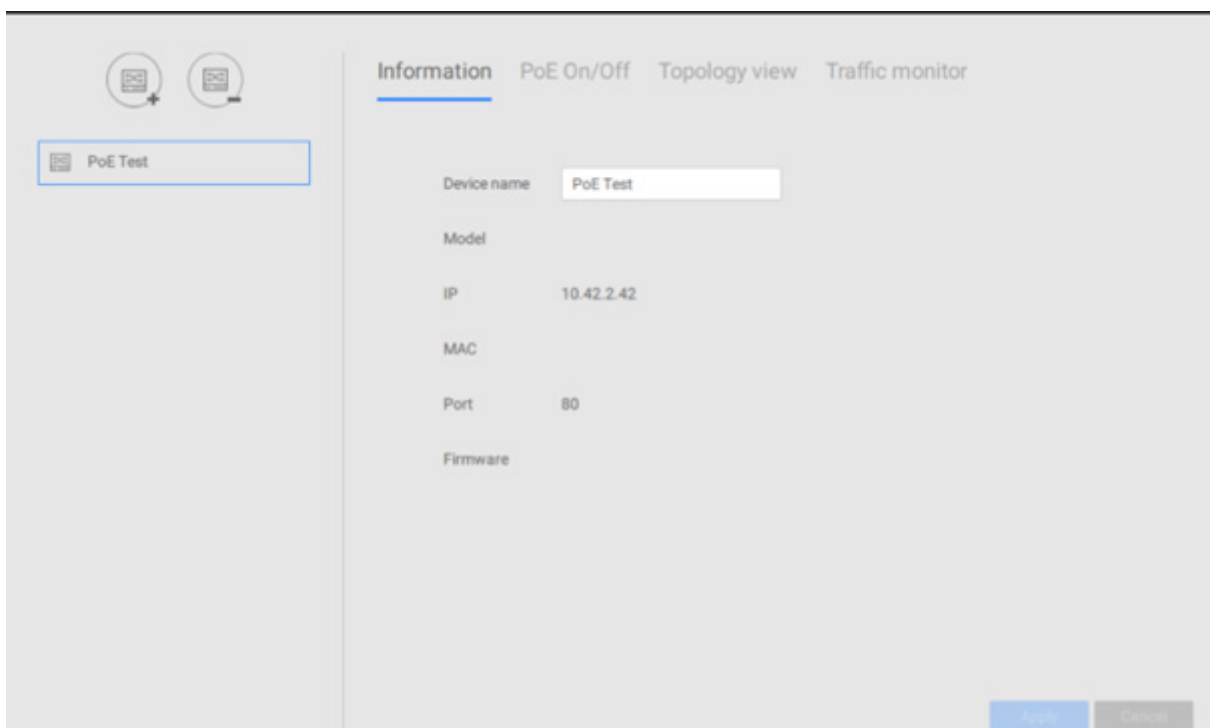

Figure 3

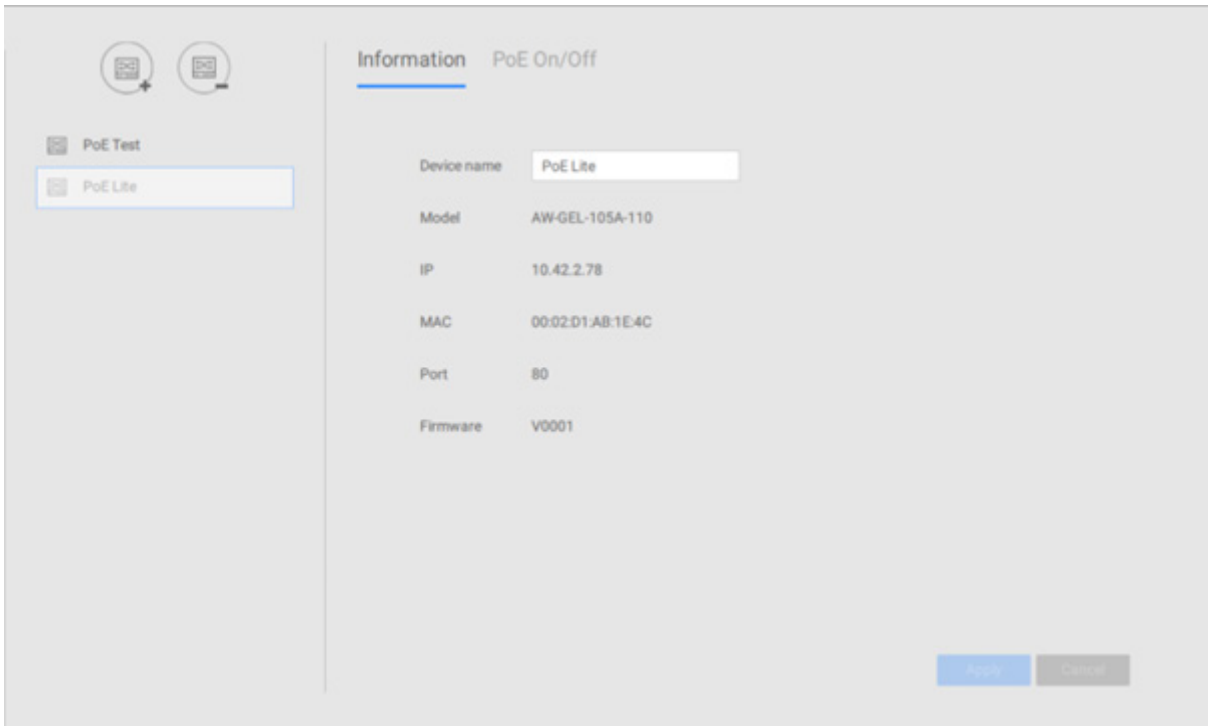

Figure 4

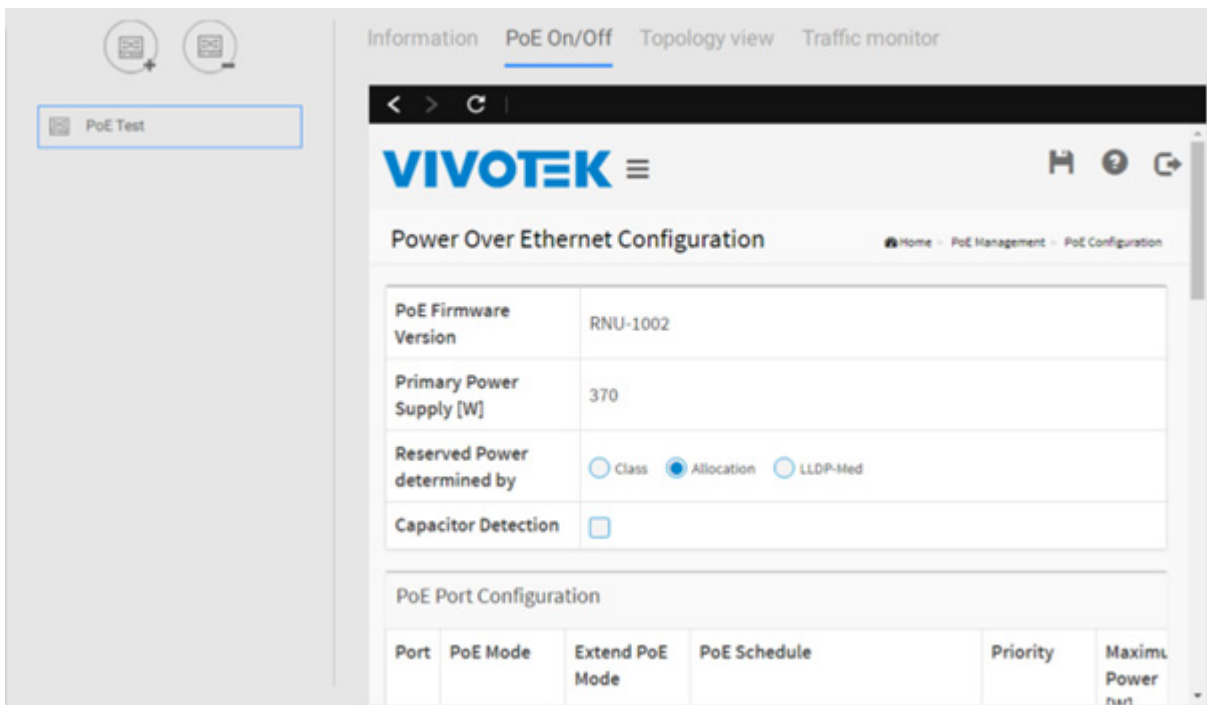

Figure 5



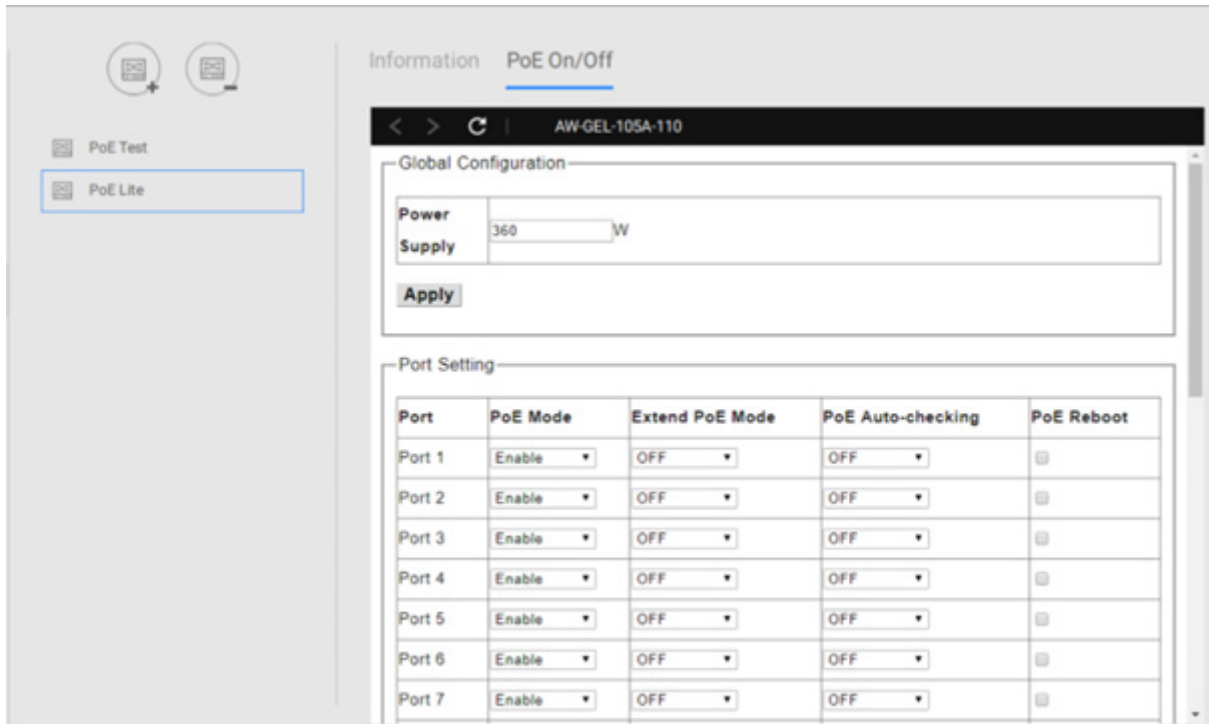

Figure 6

On the Topology view page, as shown in Figure 7, you can view all the connected cameras or devices of the switch, and you can operate basic troubleshooting for the connected cameras, including reboot/diagnostic.

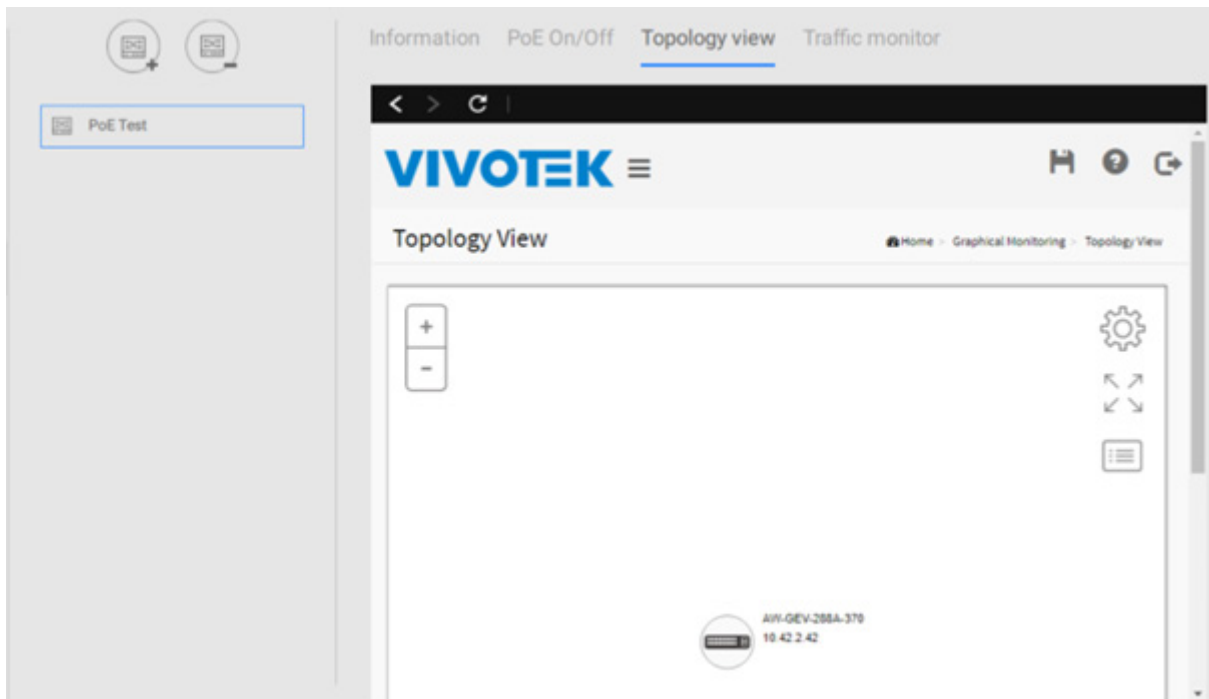

Figure 7



On the Traffic monitor page as shown in Figure 8, you can monitor network bandwidth for each switch port.

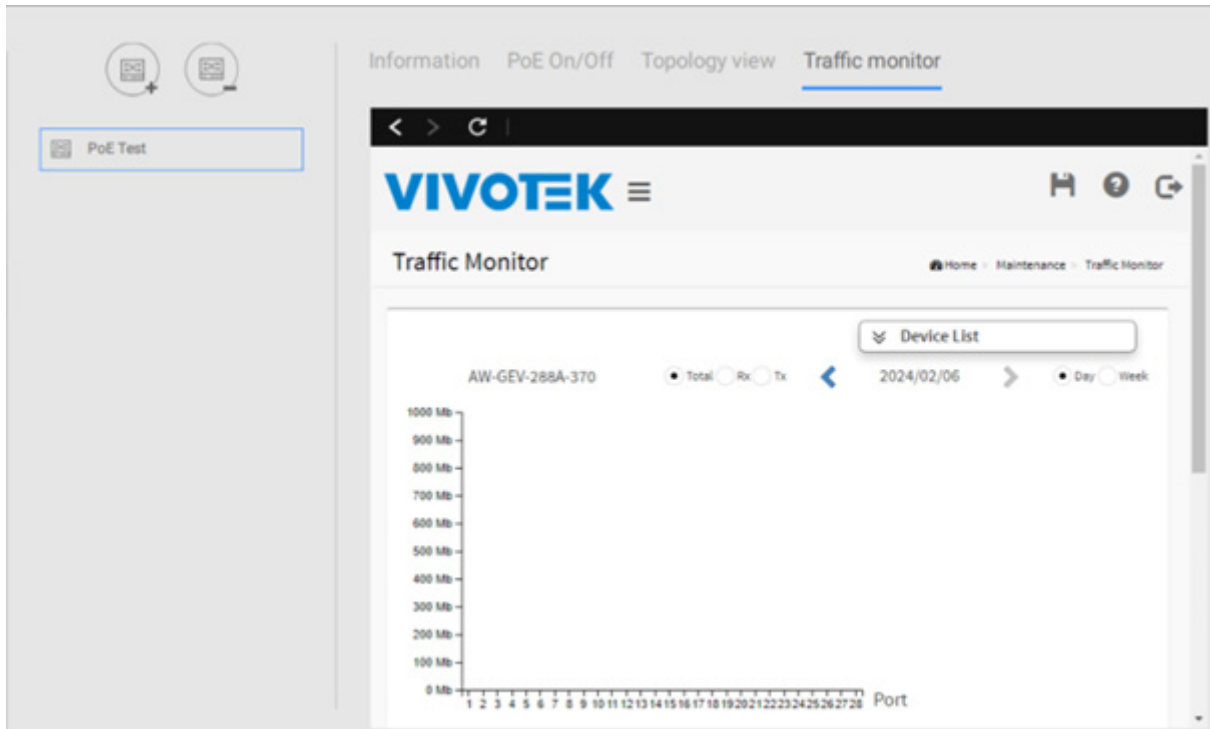

Figure 8



Chapter 4: Settings

4-1. Settings > System > Preferences

The Preferences page for VSS client and Station sides allows you to configure the following:

Client Setting:

1. Select the UI text language.
2. Configure a default destination for exporting video, snapshots, or configuration backups. The default is "C:\Users\Public\Documents\VIVOTEK Inc\VAST\Downloads". You can change the media format via the checkboxes.
3. Select the format for the snapshot as either JPG or PNG.
4. You can select the length of the Alarm-triggered videos by specifying pre- and post-alarm recordings.
5. You can designate the VSS client interface to automatically start once the client computer is started.

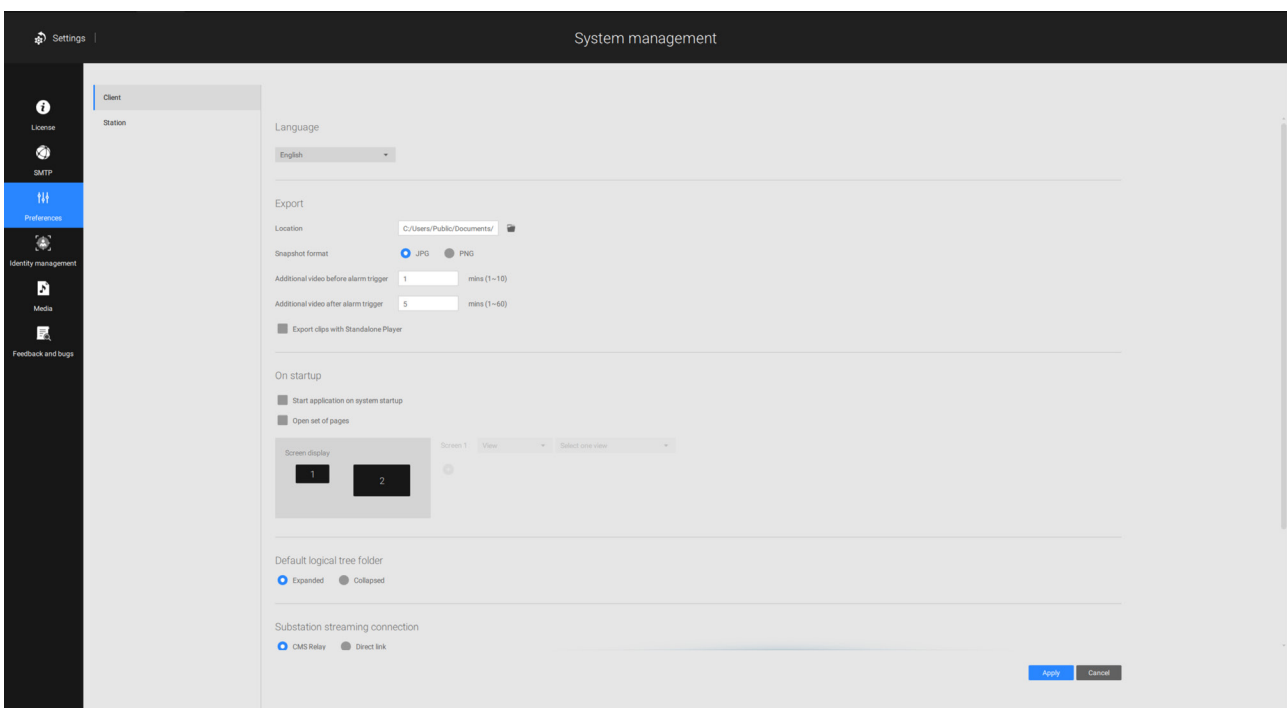

6. The default Live view, which may span across multiple monitor screens and display Live view, Tour, Dashboard, E-Map, or Alarm prompts. The precondition is that you should configure one or many views before making the Startup configuration.

Below is a server/client with dual monitors, you can select one view to be displayed on one monitor, or place an E-Map on another.

Click the Apply button for the configuration to take effect.

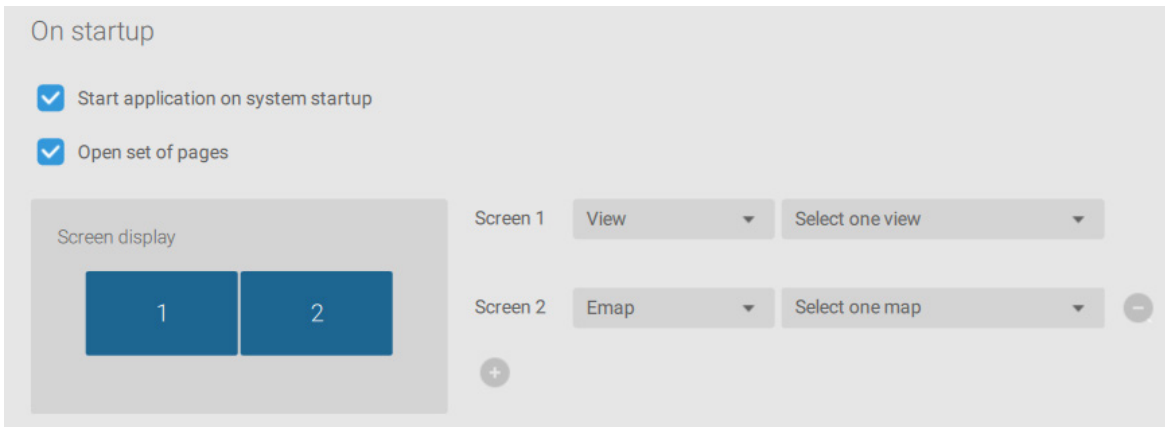

If you plan to have one monitor to be working for other purposes, select No display for this monitor.

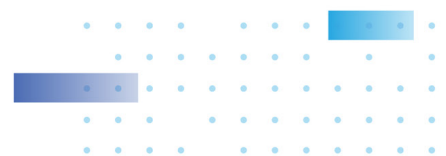
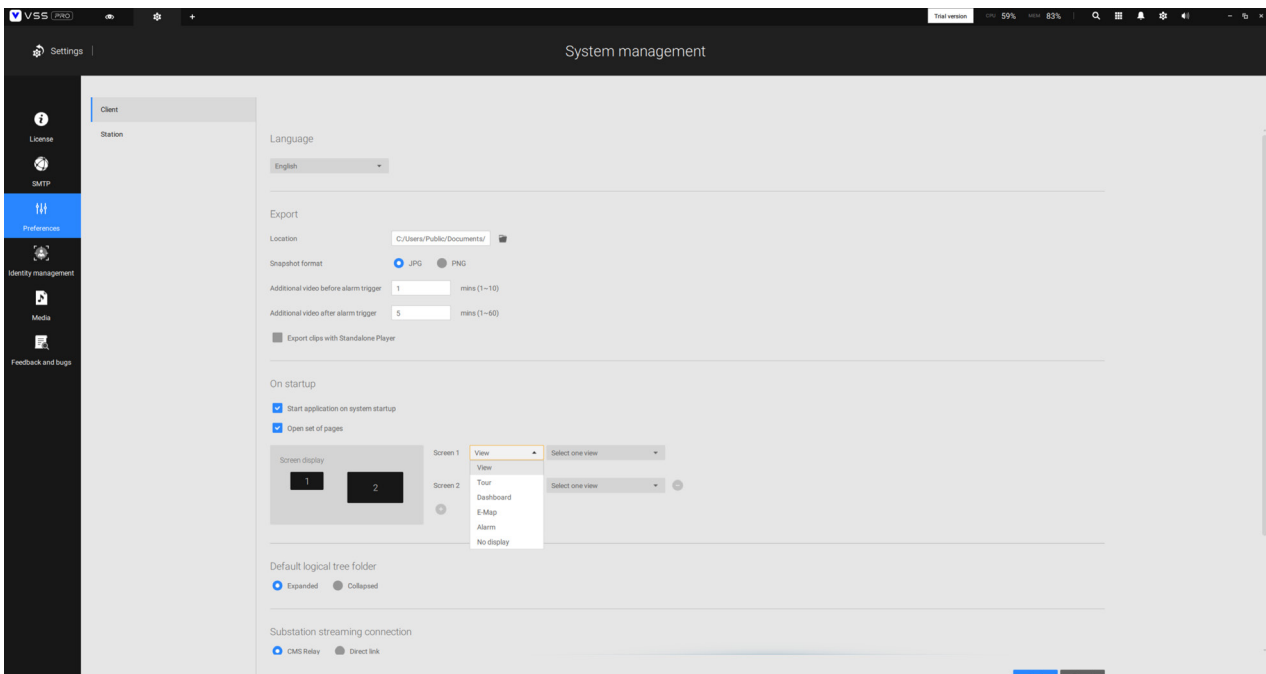

Below are the additional system parameters:

Default logical tree folder: Expanded or collapsed.

Substation streaming connection: CMS Relay or Direct link. Direct link allows a client station to access camera live stream from the sub-station under a CMS main station. CMS relay - A client accesses live stream via the CMS main station.

Show system warning: When a client computer is running short of virtual memory, a warning will display.

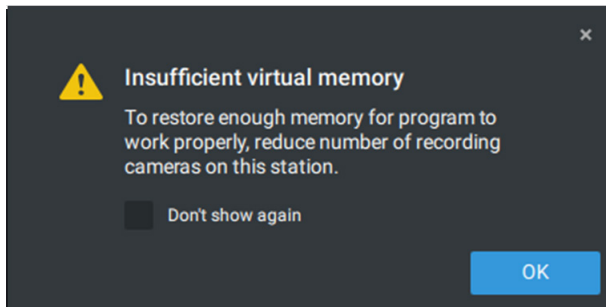
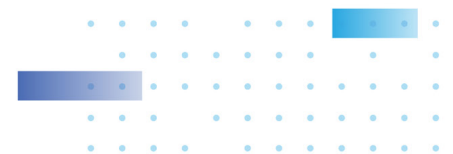

Image resampling method: Select a resampling method if the need should arise.

Click the Apply button for the configuration to take effect.



Station Setting:

1. Deep Search - Only users with an admin account can see and manage this setting. Turning it on allows VSS to utilize and store person attributes and full-body/face images for improved people search. Additionally, you have the flexibility to decide whether to enable or disable VSS from utilizing and storing face snapshots based on your specific needs. The stored data will be recycled with recordings based on the recording recycle setting. Before turning it on, ensure compliance with regional privacy laws and obtain consent from individuals for using their attributes and images if required. Once the Deep Search function is turned off, Deep Search cannot function, and the Deep Search icon on the view cell for the VIVOTEK AI cameras will be switched to the Smart Search icon. Note that the setting will not be applied successfully if the software versions among clients and servers are incompatible.

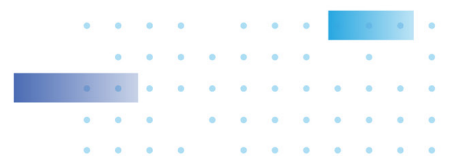
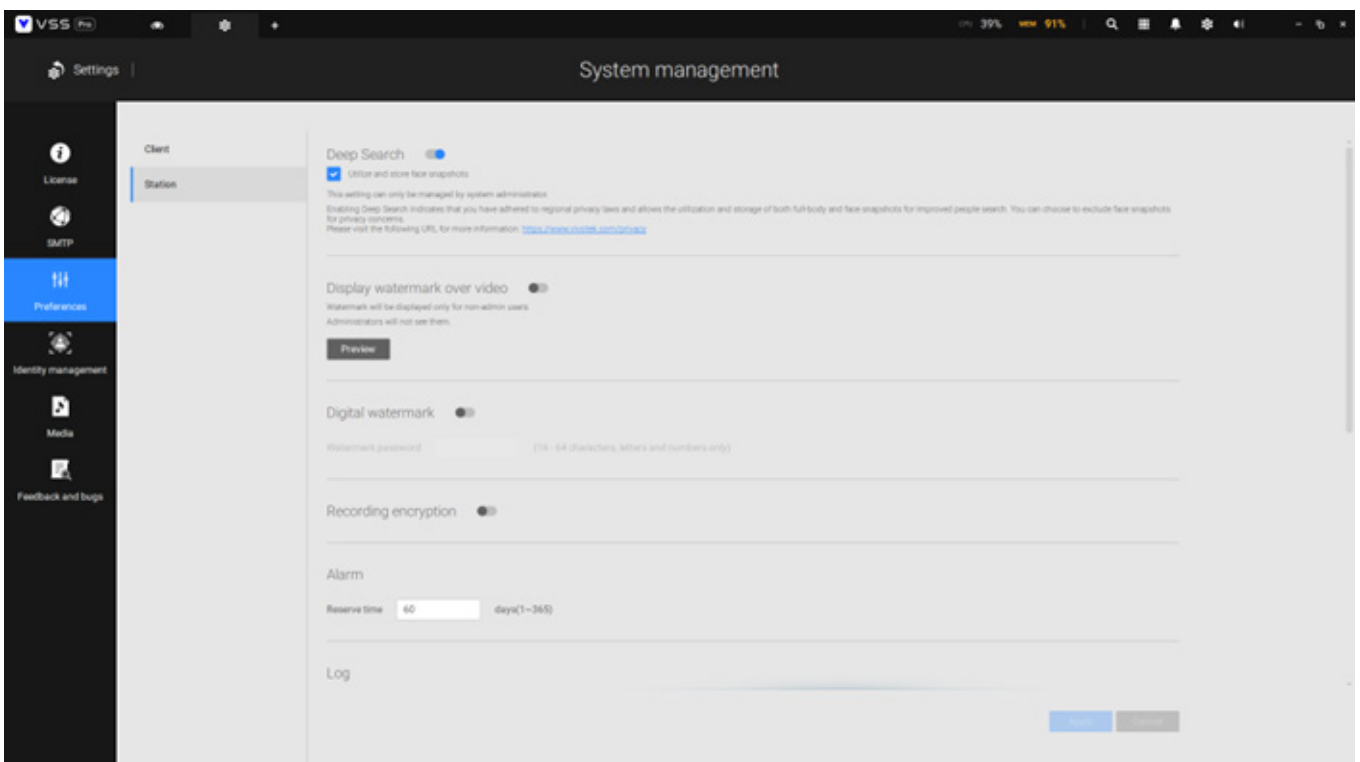

2. Display Watermark over video - Administrators can select to display watermarks on the video feeds of the VSS clients. The opacity and display frequency can be adjusted.

Encrypted watermark for authentication:

To ensure your video is authentic and has not forgerized, adding an encrypted watermark on the data stream can be achieved with a customized password. You can use the Standalone Player to verify which frames in the video footage have been tampered with.

If enabled, the following will be displayed: **camera name + substation name + VSS user name + user computer current time**. The purpose of watermark is to preserve evidence if the video screen is recorded using cell phones or other devices.

Station Setting:

3. Digital watermark - To prevent forgery of recorded or exported video clips, and to prove the validity of surveillance evidence, digital watermark can be appened to recorded video.

Note that only non-administrator users will see watermarks.

To enable text watermark, use the slide button. Use the Preview function to tune the text opacity and text frequency display on screen.

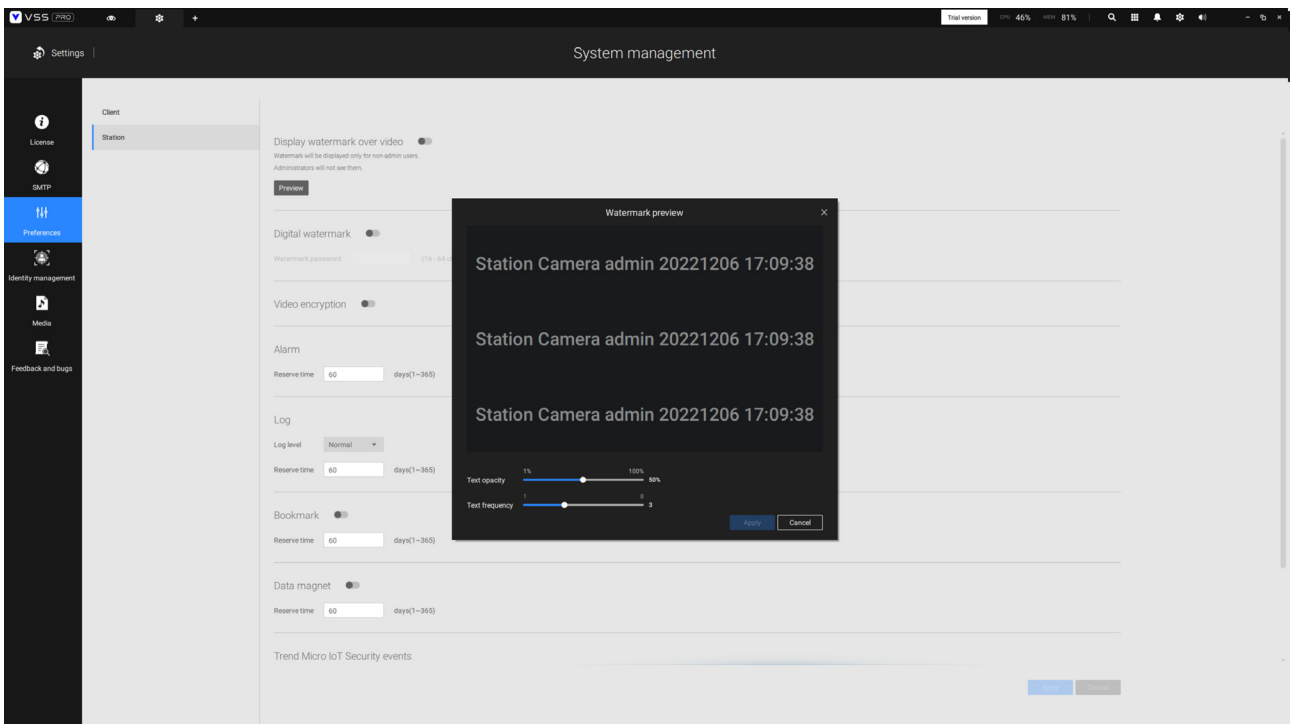

To enable Digital watermark, enter a password that is at least 16 characters long. Once a valid password is available, you can click the Apply button to preserve your setting.

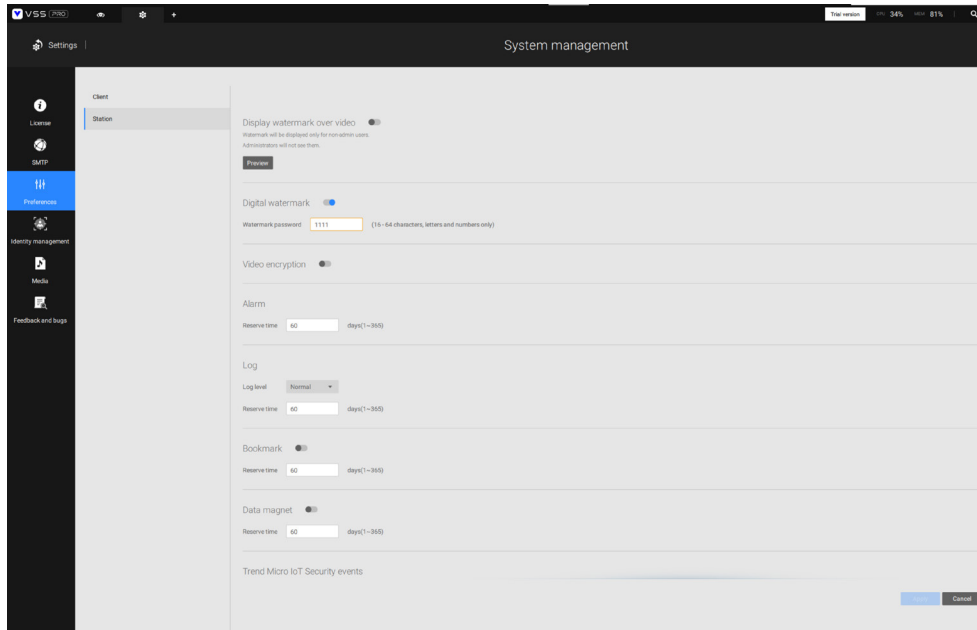

When you export a video clip, a StandalonePlayer is generated with the exported files.

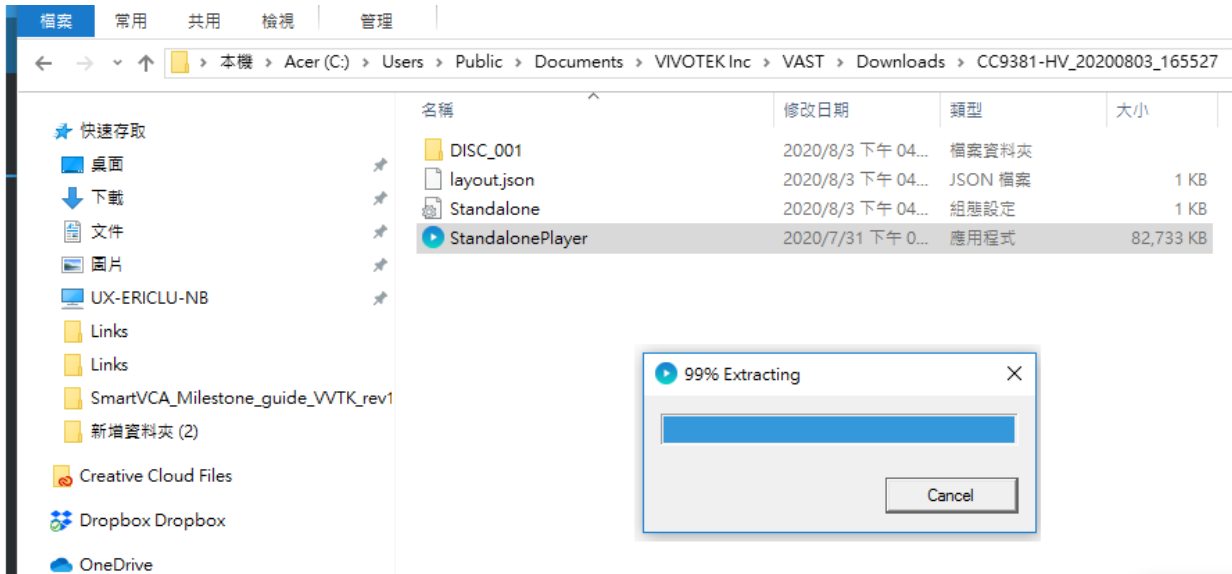

Right-click on the StandalonePlayer screen to display the "Verify watermark" function.

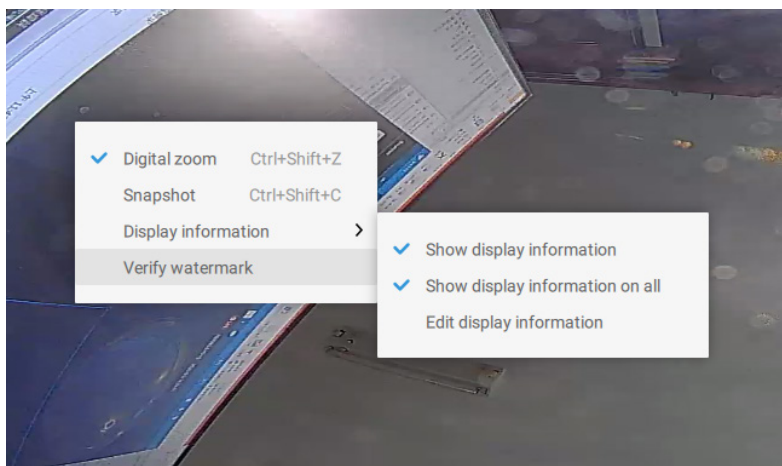

The Verify screen will display. Enter the pre-configured password. Click Verify.

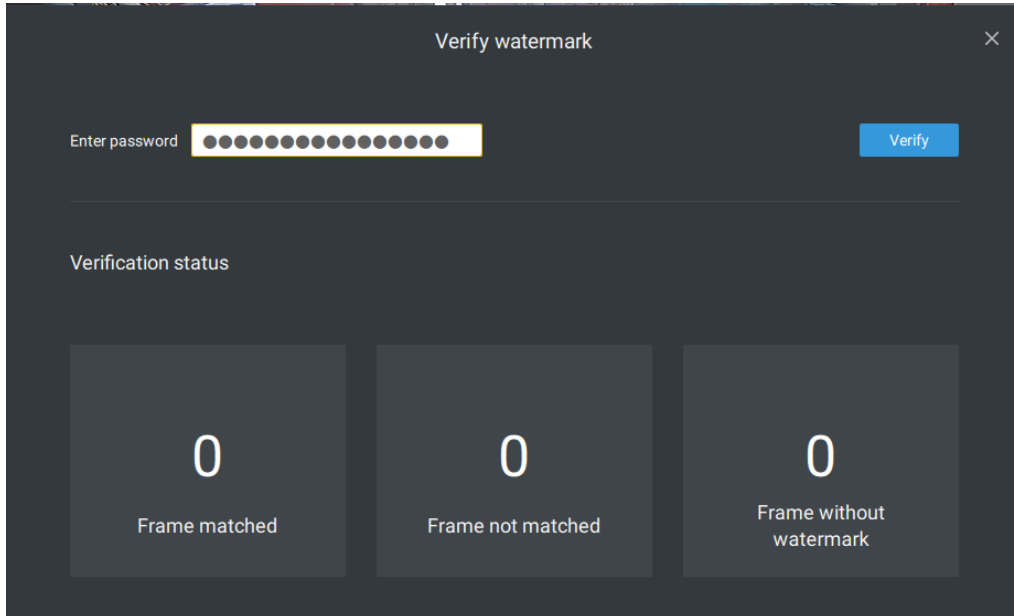

The below result shows that the video is authentic and has not been forged.

Frame matched: Your video was exported with the digital password, and you entered the correct password.

Frame not matched: Your video was exported with the digital password, and you entered the incorrect password.

Frame without watermark: a. If your video wasn't exported with the digital password.

b. If your video was exported with the digital password, and your video has been tampered.

If the numbers in the "Frame not matched" or "Frame without watermark" are not zero, it means your video is probably not correct.

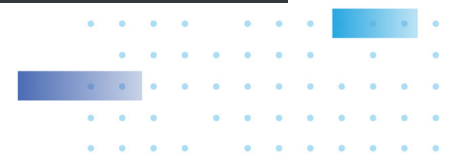
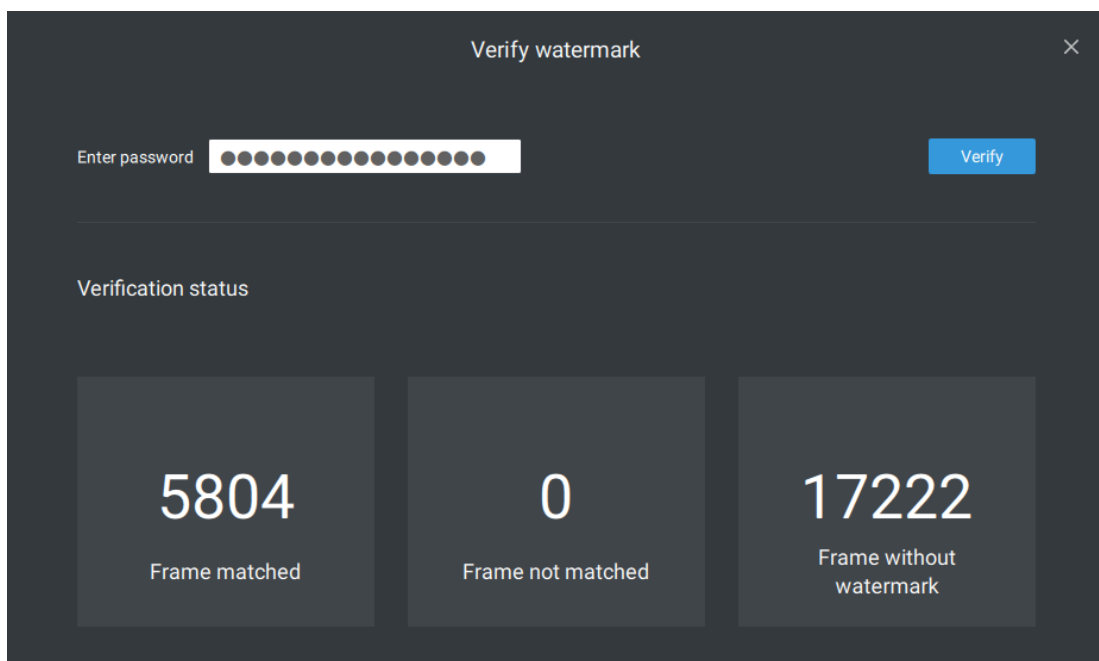

4. Alarm - Reservation time: Configure the preservation time of the alarms and logs. Note that some alarms can be triggered with recorded videos. Configuring a preservation time can help reduce the use of storage space on server.
5. Log: Use the menu to configure the preservation time of the Major, Normal, or Minor logs.
6. Bookmark: Configure the days of preservation for bookmarks.
7. Data magnet: Configure the days of preservation for data related to Data Magnet.
8. Trend Micro events: Configure the days of preservation for events related to cyber security.
9. Database: Configure the destination of the database folder. The database contains information for system log, alarms, Bookmarks, data magnet, VCA reports, POS transaction data, snapshots, and Trend Micro IoT security information.

Recording Encryption - Recording encryption allows users to encrypt the recording videos with password protection. Playing the encrypted video on the original VSS server does not require entering the password.

Playing on other VSS servers or disabling recording encryption will require entering the password. The password is not able to recover or reset if you forget the original password.

Encrypted video files (.3gp) cannot be played in other media players. Please use the following two methods to view the video files outside the original VSS server.

1. Import to other VSS servers as Local DB
 - a. Copy the entire recording folder from the original VSS server to another location.
 - b. Enter Settings > Recording > Local DB in another VSS server.
 - c. Add local DB with VMS/CMB backup type.
 - d. The recording will be mounted as a local DB and listed sub-tree.



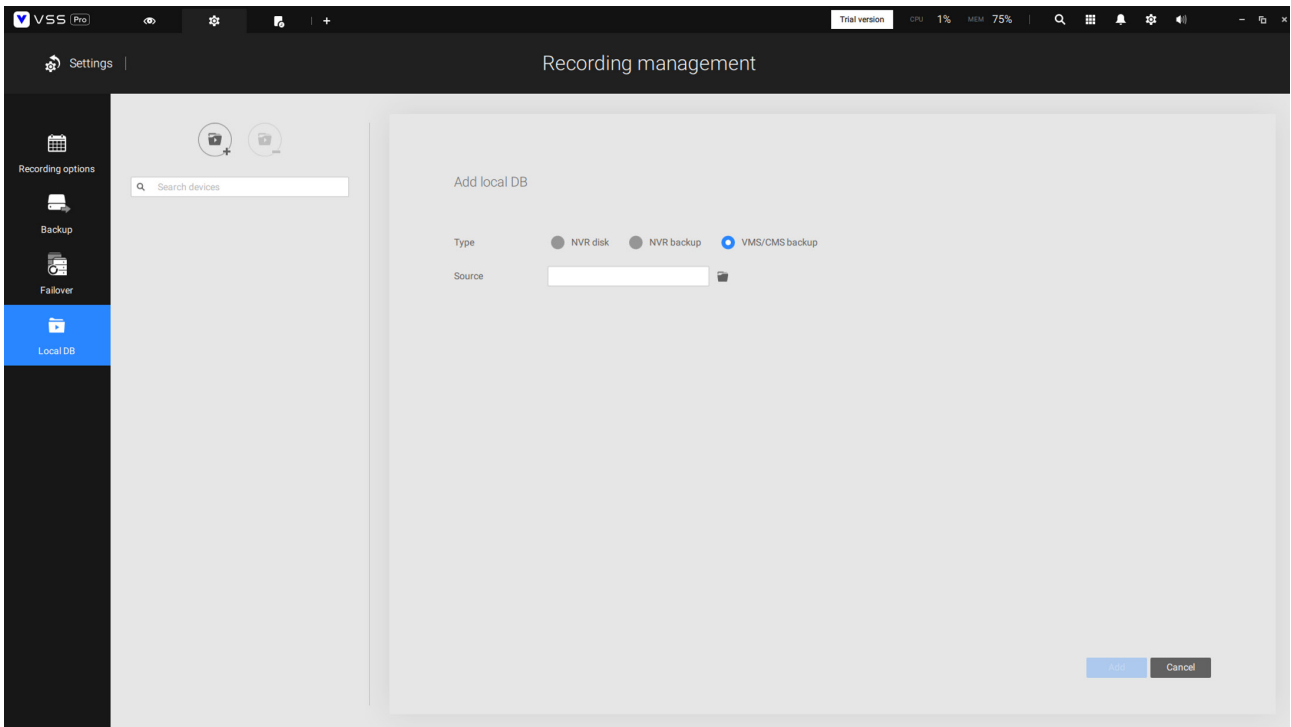

2. Import to VSS Standalone player as Local DB

- a. Copy the entire recording folder from the original VSS server to another location.
- b. Launch Standaloneplayer.exe in C:\Program Files (x86)\VIVOTEK Inc\VAST\Client\VSS\
- c. Add local DB with VMS/CMB backup type by dragging the entire recording folder or using the "+" button.
- d. The recording will be mounted as a local DB.

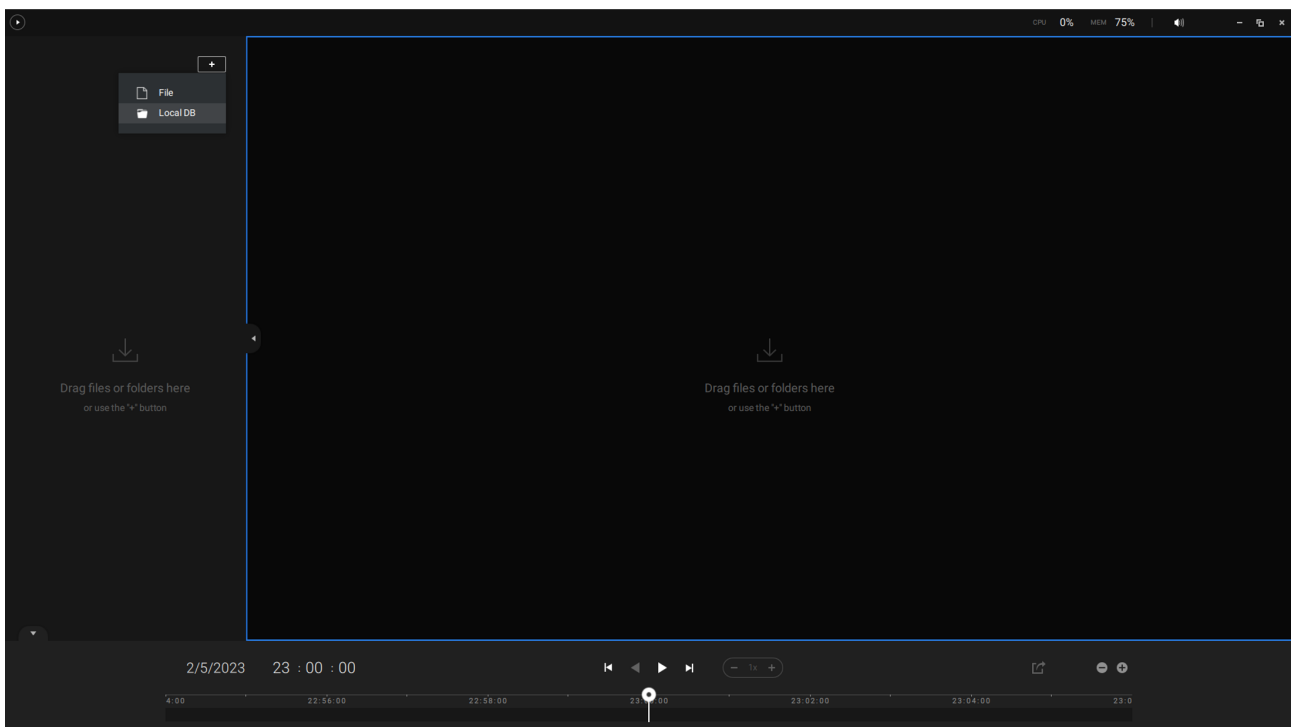

4-2. Settings > Device > Cameras

In addition to the add device process during the initial setup, you can add more cameras or arrange the device list in Settings  > Device > Cameras.

Below are the locations of the functions for adding devices to the VSS server.

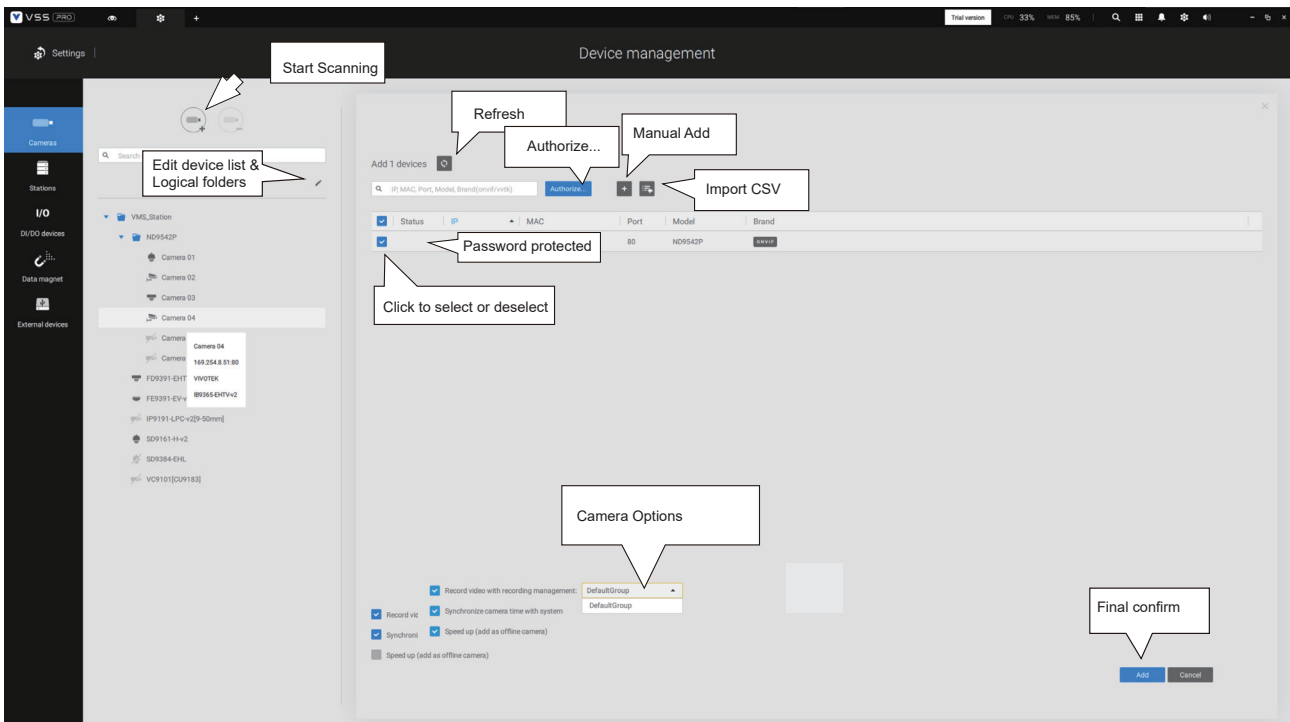

Note that you must know the credentials for password-protected cameras. You will not be allowed to enlist cameras that come with unknown credentials.

For cameras outside the local network, you can manually enter its IP address, or use a pre-configured device list to automatically introduce new devices.

If all devices come with the same credentials, you can select these devices and click Authorize to enter the credentials.

Record video with recording management: You can decide which recording group to record the videos to using a pull-down menu.



Speed up (add as offline cameras): Normally, you should have all the credentials for the access to all network cameras. However, in the condition that you add a large number of cameras using the "import devices from device list" function, you can temporarily use this speed up option to add these cameras.

This applies when the cameras have not been installed (have been prepared for installation), but you want to add them to the camera list. When cameras have all been installed, VSS will attempt to connect with them.

- Retrieve RTSP streaming on specific port: The default port for RTSP streaming is 554. If you want to change this port, please check this item and fill in a desired port number.

Streaming URL

This is an optional feature. You can enter a camera's IP address to add a camera's RTSP streaming for live view and recording, and playback. The feature enables the support for obsolete models.

To insert a camera using the URL-like command,

1. Select the camera Brand as "RTSP."

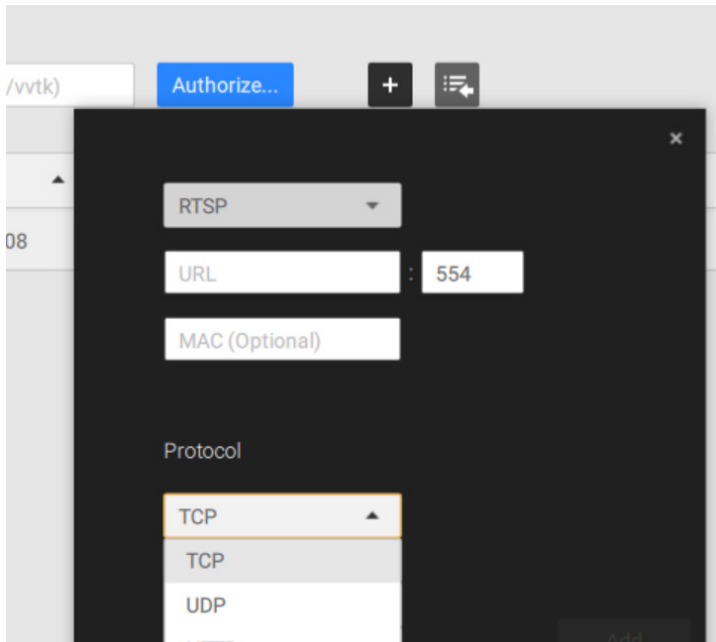

2. Enter the camera's IP address.

3. Enter the camera's MAC address as printed on the camera label, or one found by the Shepherd utility.



4. Enter "554" in the Configuration port.

5. Enter "live.sdp" in the URL field, as this is part of the original RTSP streaming command: "rtsp://172.18.204.58:554/live.sdp". If streaming stream #2, enter live2.sdp.

6. Select a preferred protocol.

Only the live view, recording, and playback functions are supported if thus connected. All other functions are not supported, such as auto streaming size or changing to another video stream. Neither are camera DI/DO supported.

7. For administrators who need to synchronize device time with an NTP server, he can deselect the "Synchronize camera time with system" checkbox.



4-3. Logical Folders

The Logical Folders allow you to re-define the logical relationships between the real-world deployment and the physical devices (cameras). For example, according to your deployments, you can designate several cameras to be listed under a logical sub-directory named as "Building A," and the other cameras into "Building B." In this way, you can re-arrange your cameras and devices on a tree view that is geographically more accurate.

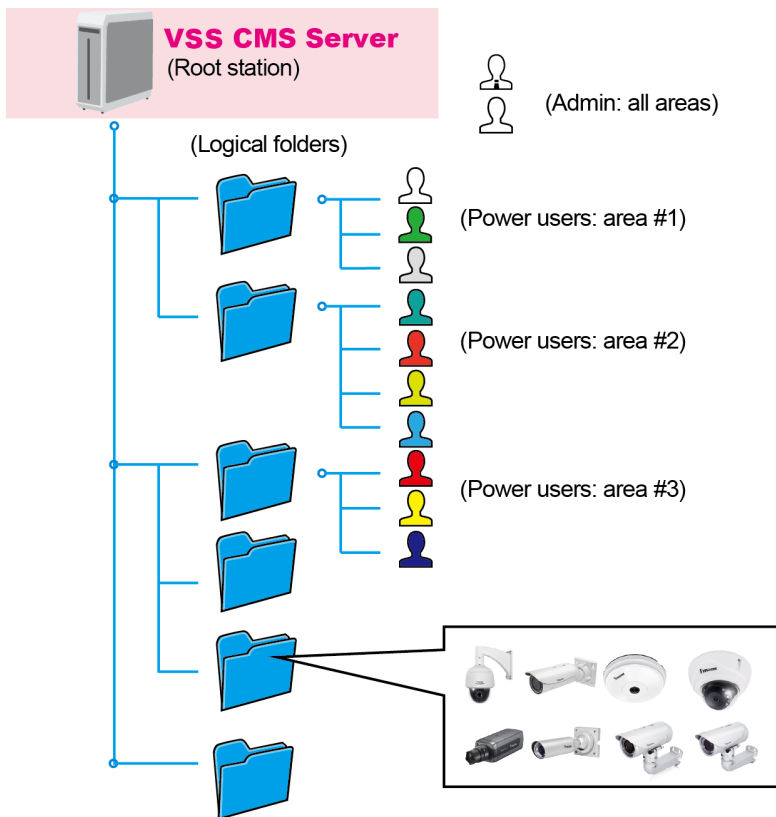

To create logical folders,

1. On the Settings > Cameras page, click the Edit  button.
2. Click on the Add a folder button.
3. Enter a name for the folder, e.g., 1st floor, 2nd floor,... according to your needs as shown below.
4. Repeat the process to create more folders.
5. Make sure you enlisted all cameras in your deployment. You can start moving cameras to specific folders. Click on the Move Selected Items button.



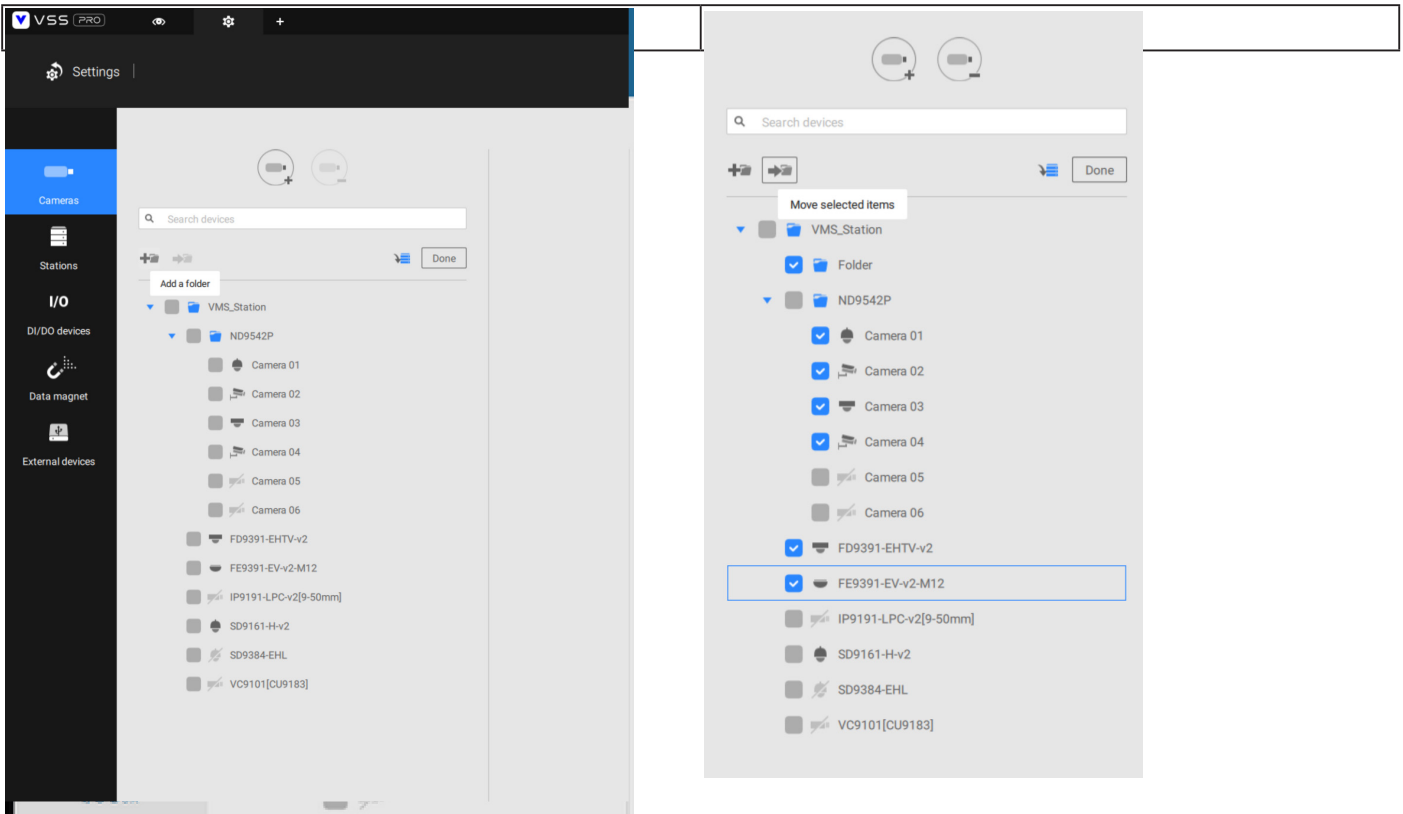

6. Select a logical folder to move the devices to. The selected devices will be listed under the logical folder you selected. Repeat the process to move cameras to each logical folder.

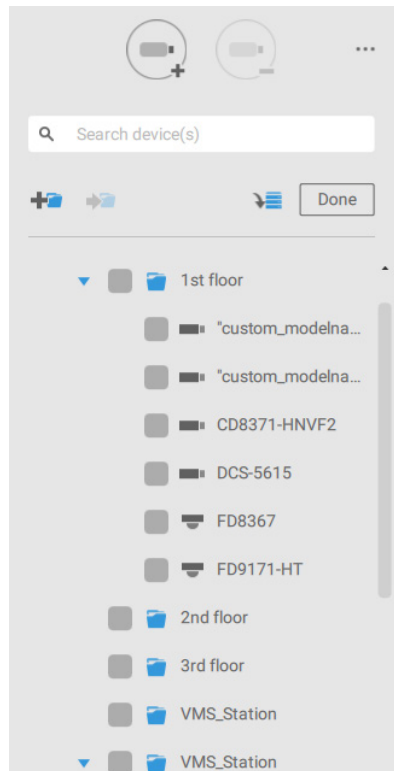
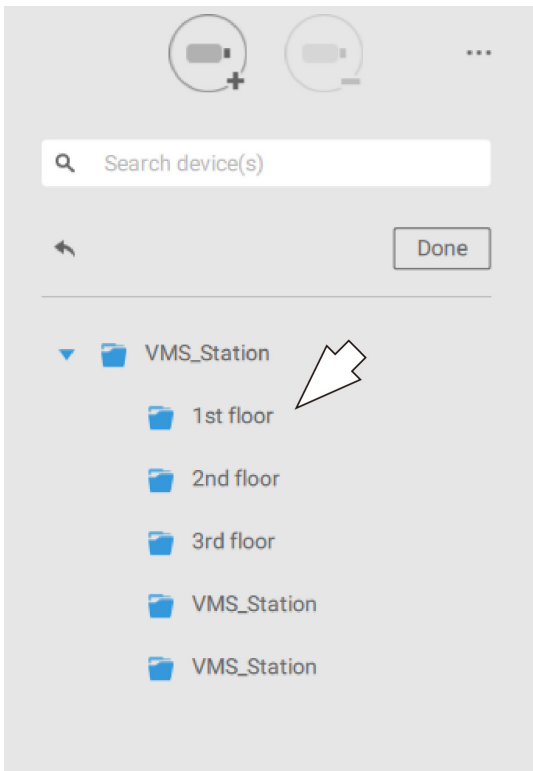

You can also use the add device button to select devices from the list and move them to a specific folder.

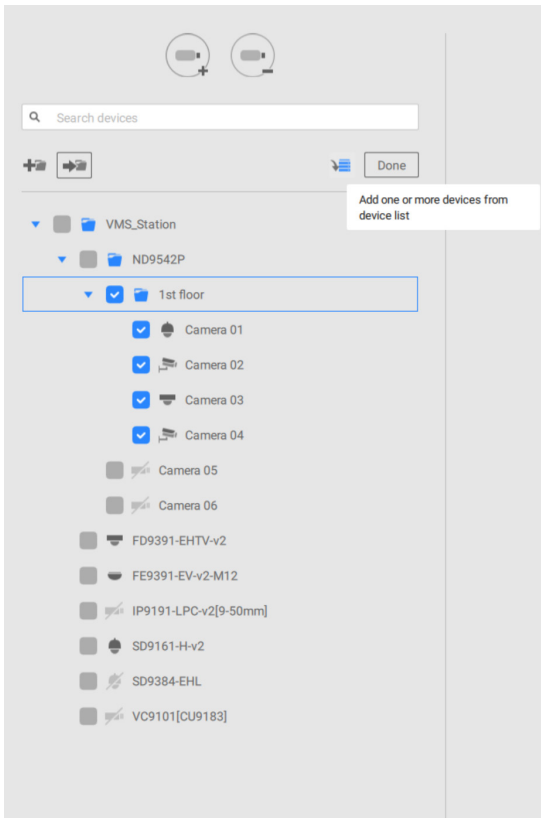

Return to live view, and you can see the configuration change takes effect.

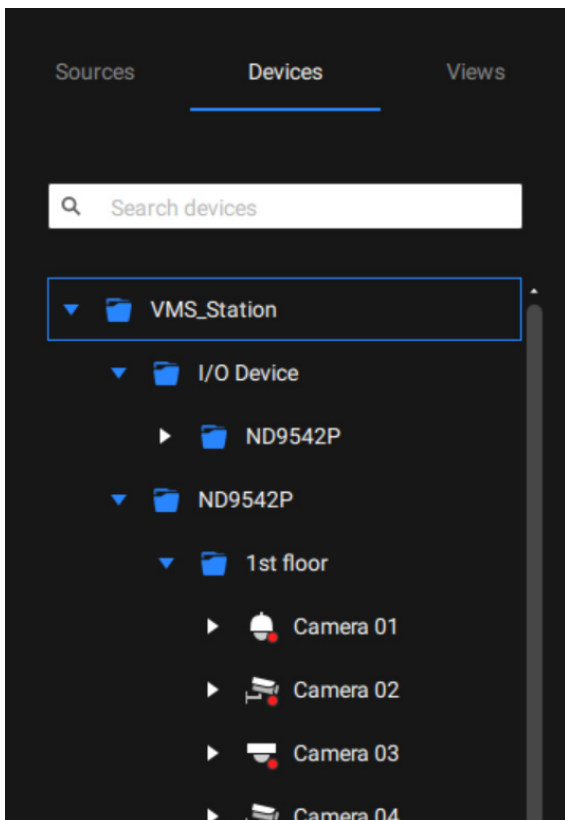

4-4. Settings > Recording > Recording Options

Click Settings > Recording options. The Recording options window will prompt.

You can configure recording schedules or select the storage options, including the configuration of an external NAS storage. You can designate a recording folder of your choice.

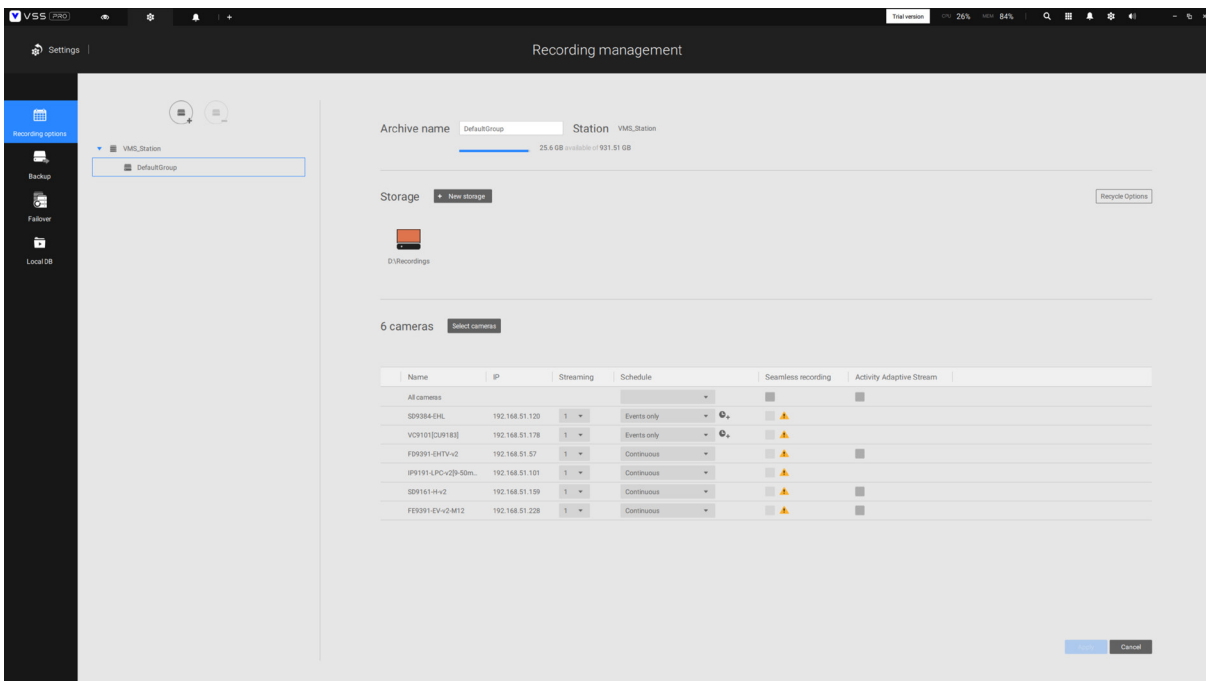

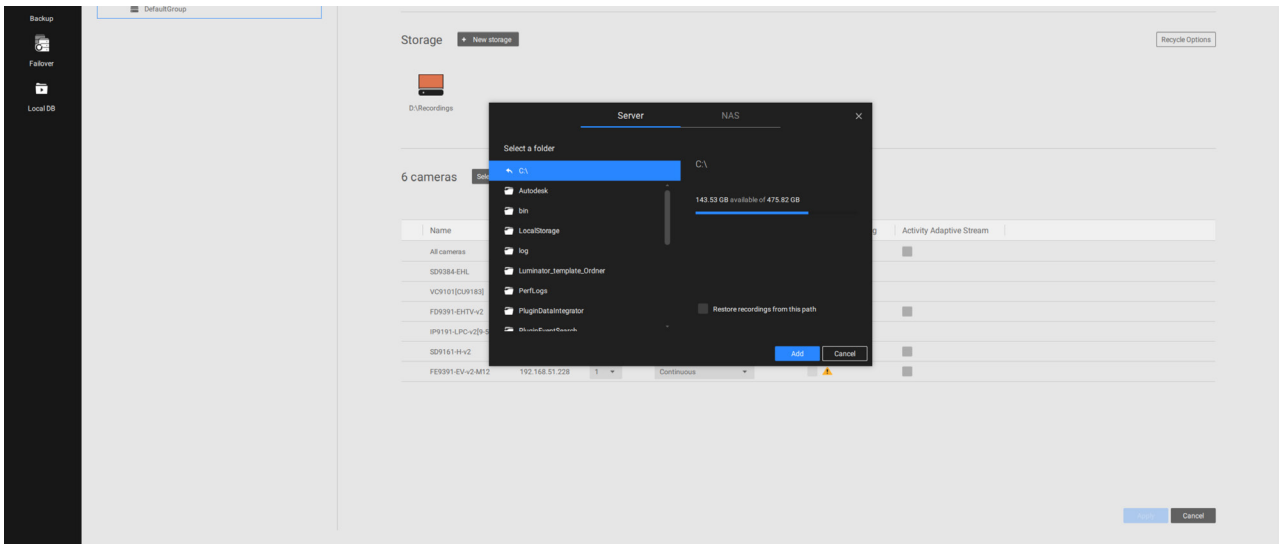

Click on any of the options on the Schedule panel for a recording option: Continuous recordings, Events only, None, or Customize.

You can manually create a recording template using the New template **+ New template** button.

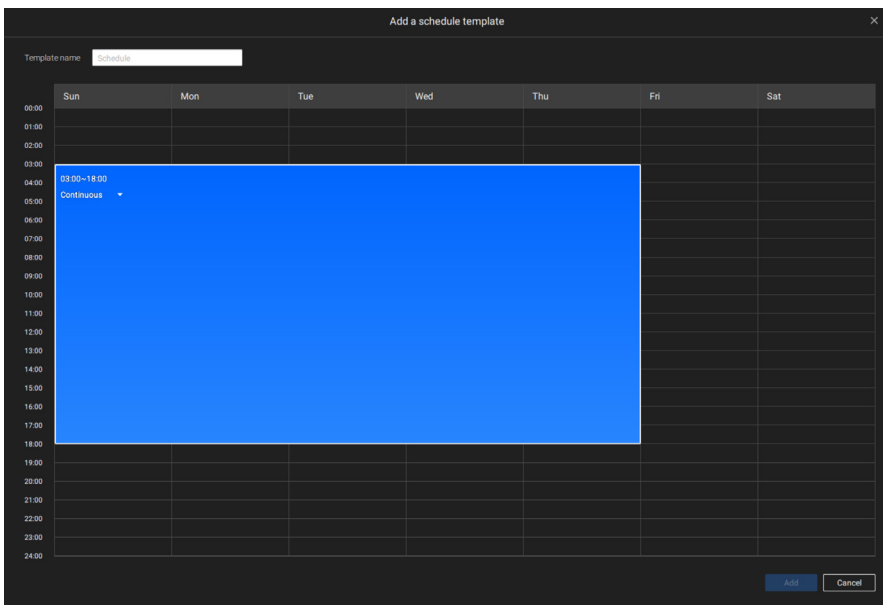

Click and hold down on the time cells, and drag the mouse to include the time span of your preference. The minimum selectable unit is half an hour. You can select multiple time spans on the template. Enter a name for the template, and click Add to save your template.

The same configuraion window apply to both the Schedule template and the customize schedule windows.

Make sure a Schedule mode is selected when you leave this configuration step.



4-5. Settings > Recording > Backup

The Backup function allows you to regularly back up the video recordings of one or multiple cameras to local hard disks or a Network Attached Storage device. Currently, the VSS server does not support backup to external storage devices such as a storage devices connected via Fibre Channel. VSS supports backup to an external storage attached through a USB 3.0 connection.

Note that the alarms associated with individual cameras will not be backed up.

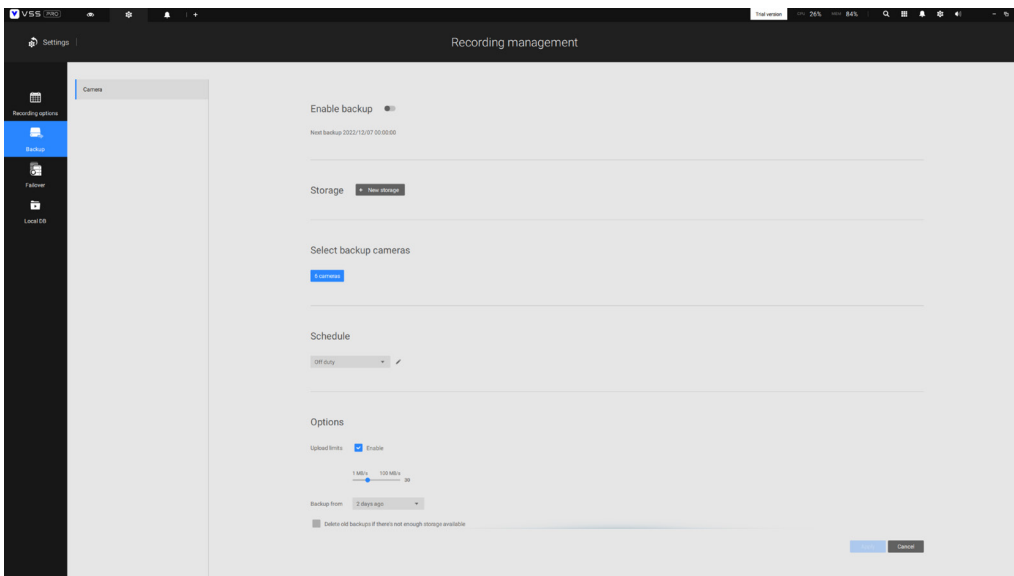

To enable a backup schedule,

1. Enable the backup by selecting the "Enable backup" slide switch.
2. Click to add New storage. A configuration window will prompt showing all accessible storage. Click the NAS tab to enable access to a network share.

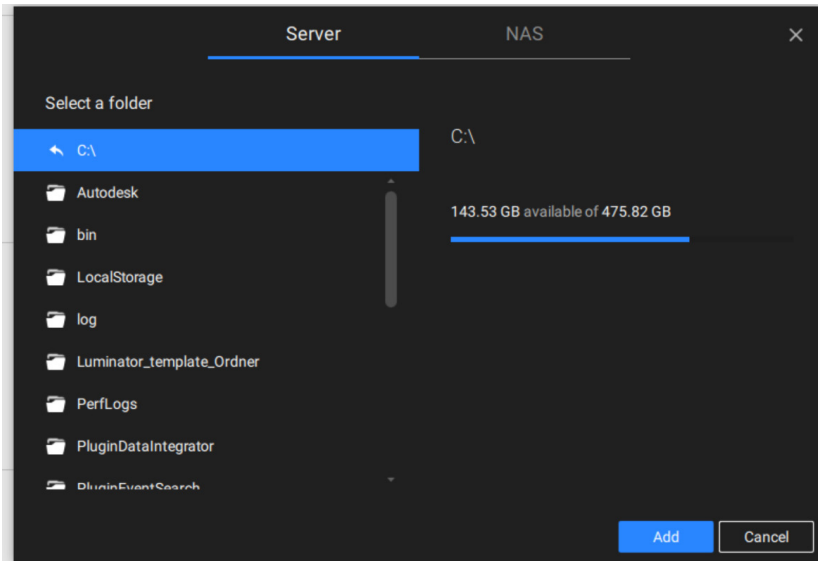

3. Select the cameras whose videos will be backed up.

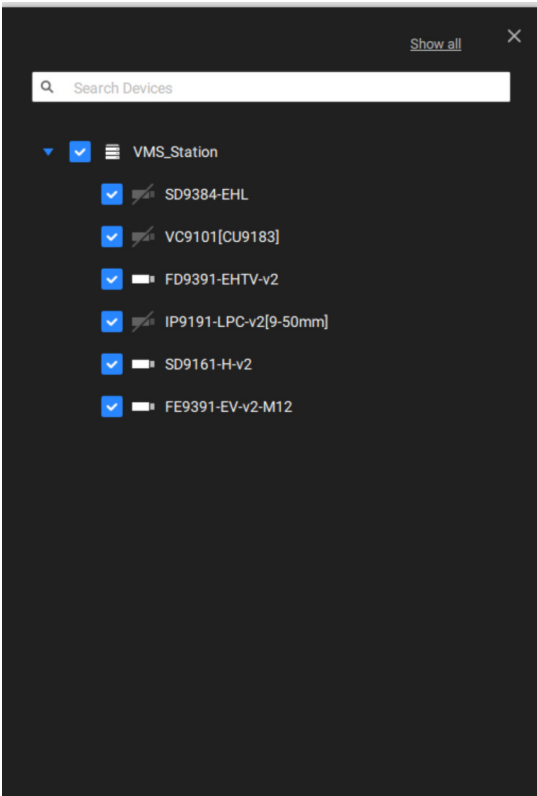

4. Select or configure a new schedule template for the backup process to take place. You can select a time when the network load is low, such as the off-office hours, to avoid network congestions.

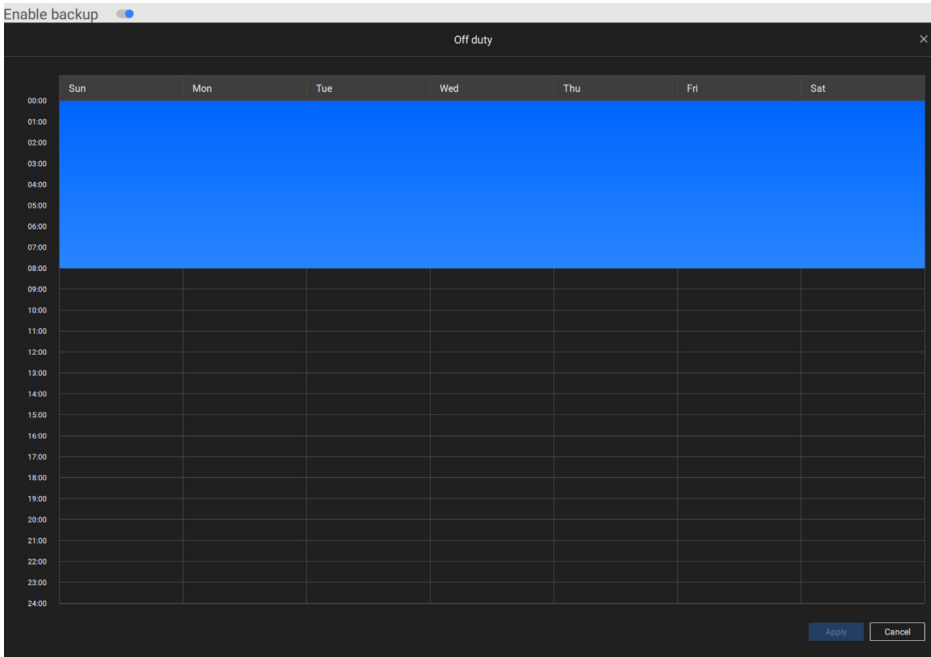

5. On the Options pane, you can configure an upper bandwidth threshold (in Megabytes) for the backup operation (for all selected cameras/channels).

You can select the extension of time, such as starting from how many days ago, of your backup task. You can select to remove old backups when you run short of storage volume.

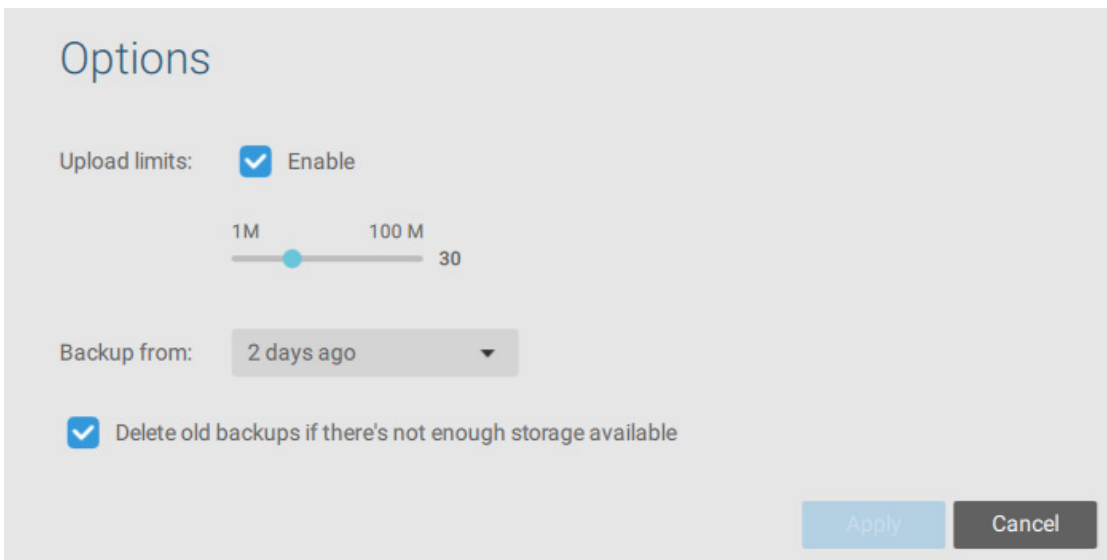

By default, VSS will check if there is a D: drive. If not, system drive C: will still be defined as the first storage option. Other disk drives in the system and the default storage volume (configured in the initial setup) will be listed.

You can add a NAS storage's shared volumes as the additional storage option. Enter the necessary information for access to a network share. Enter and select a NAS path. The share will then be available for video recording.

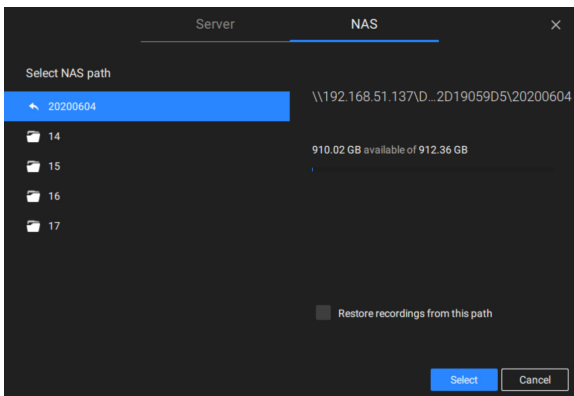

Select storage volumes each by a single click.

Click Ready to use to continue.



Mobile NVR Wi-Fi Backup (BETA)

This feature allows Mobile NVRs to initiate a backup of specific Alarm recordings upon arriving at a location with a WiFi Access Point (AP) connected to the same domain as the VSS CMS server. Only the System DI-triggered alarm is supported in the current edition.

Here are the setup steps:

To set up VSS Server:

1. Add the Mobile NVR to the VSS Server as a substation.
2. Navigate to Settings -> Recording -> Backup -> Mobile NVR. Enable backup for Mobile NVR.
3. Choose the storage path for the recordings to be backed up.
4. Set the duration for recording backups before and after the occurrence of an alarm trigger.

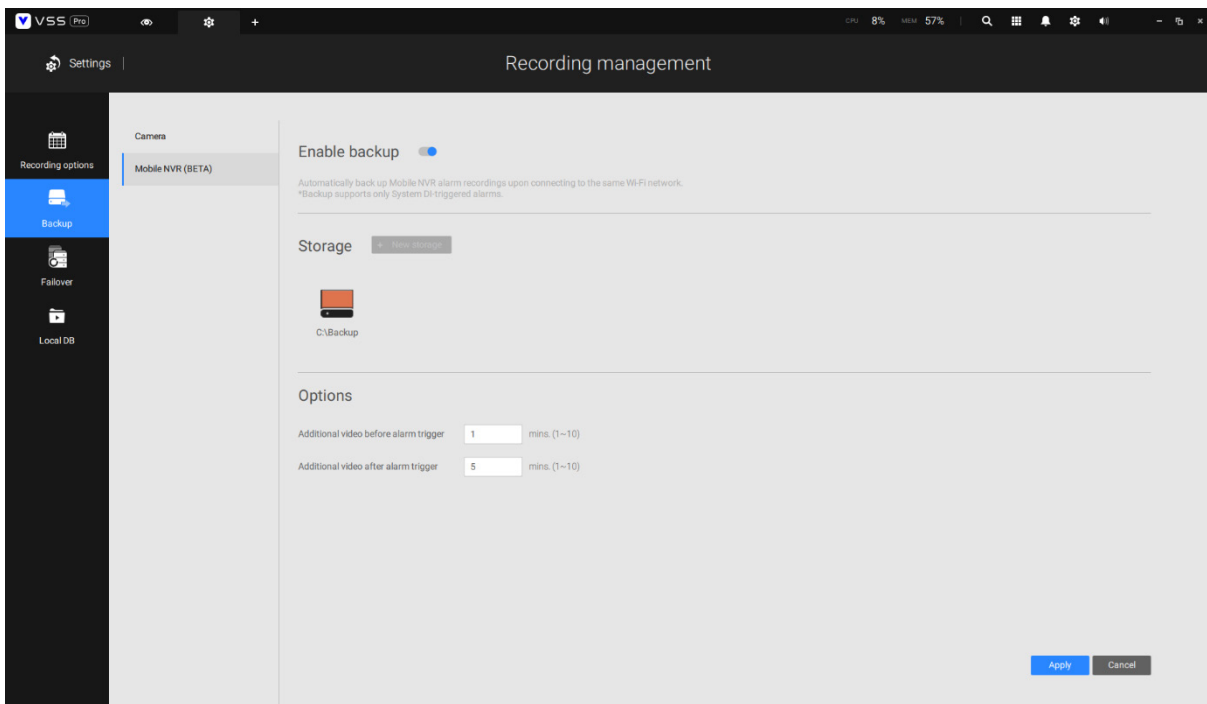

To set up Mobile NVR:

1. Set up the WiFi connection on the Mobile NVR to connect to WiFi Access Points.
2. Set up Alarm configurations on the Mobile NVR. Specify the System DI (Digital Input) as the trigger for the Alarm. Specify Video recording as an action for Alarm, including which cameras should start recording.



Once these steps are completed, when the Mobile NVR connects to the WiFi AP in the same domain as the VSS CMS server, the CMS server will establish a connection to the Mobile NVR and transfer the System DI-triggered alarms recording to the VSS server for backup.





4-6. Settings > Device > Stations

The VSS allows a deployment consisting of multiple VSS instances at different locations. A VSS server can be selected as the CMS (Central Management Server) to manage sub-stations in a hierarchical structure.

Each individual VSS station manages its own surveillance deployments. To build a hierarchy, proceed with the following:

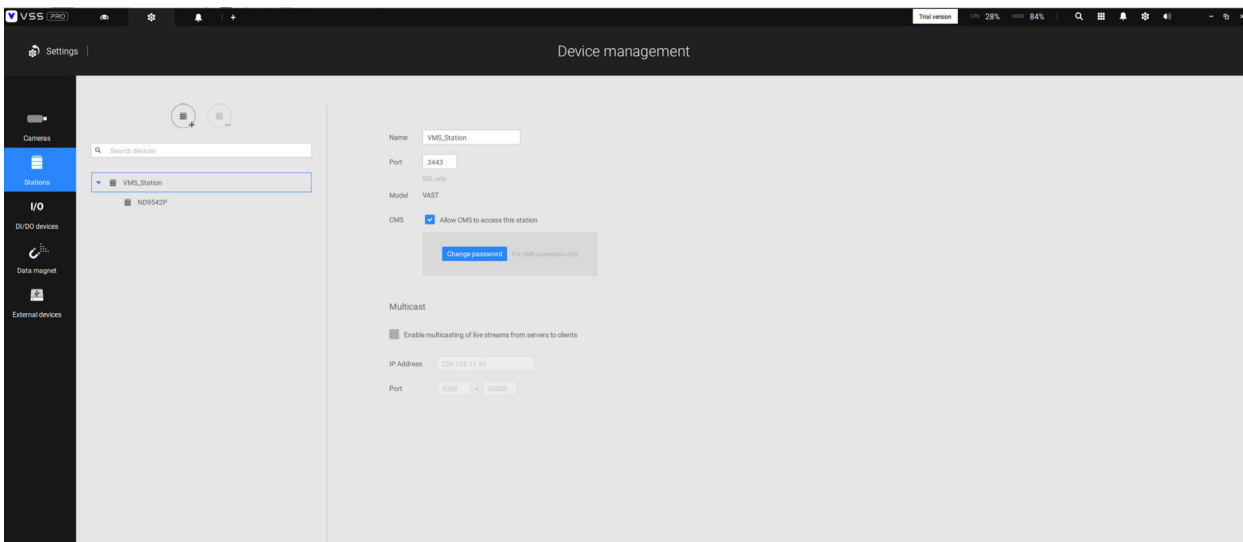
1. Open the VSS client on a substation.
2. Enter Settings > Stations.
3. Enter a TCP Port number if your network configuration requires a different port.
4. Select **Allow CMS to access this station**.
5. Click **Change password**. This password will be used to authenticate the connection between a CMS VSS server and substations.



6. Click the **Apply** button.
7. Open the VSS client on the server chosen as the CMS.
8. Click the Add substations  button.



9. You can click the Search button if the substation is reachable in a local network, or manually enter the IP address and password for making the connection.

Add new substations [Search](#)

IP/Domain name

Port SSL only

CMS password

Add as a redundant server for CMS Substations

Windows account in substation (optional) ⓘ

Host

User name

Password

10. Enter the password you configured for the Stations configuration, and then click the [Authorize](#) button.
Click the [Apply](#) button for the configuration to take effect.

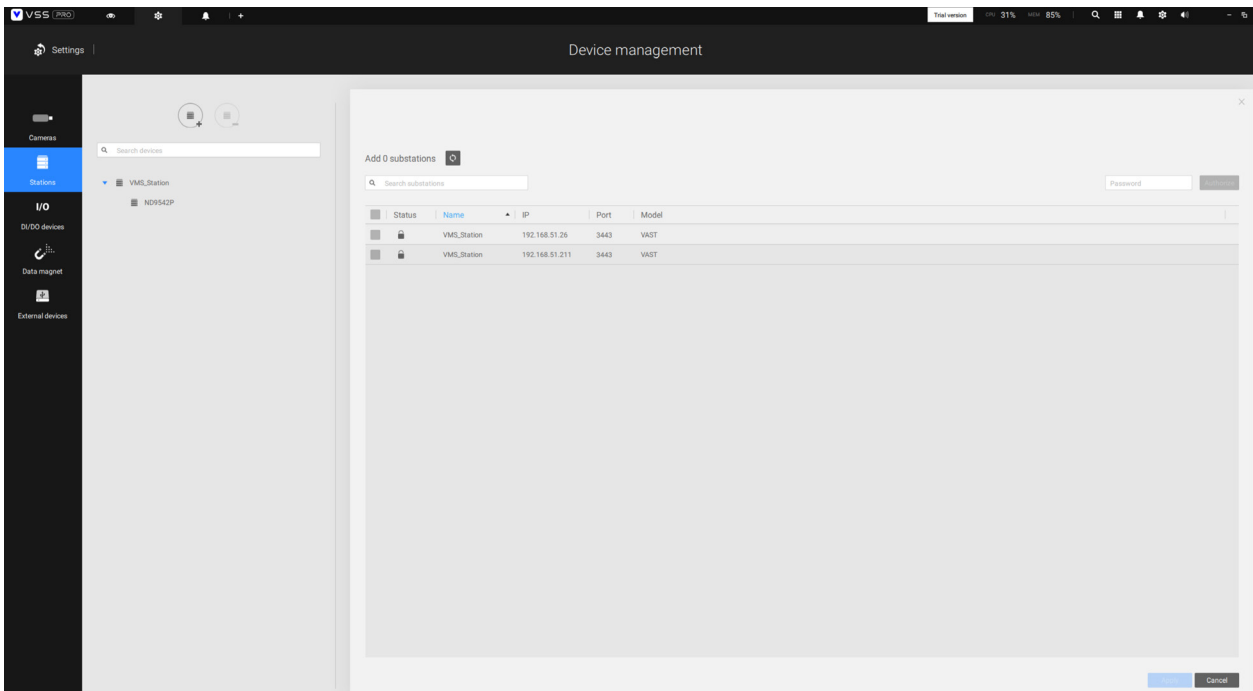

The substations and its subordinate devices should be immediately listed under the CMS station. You can create separate views to place the substations' cameras.



When you want to enlist an NVR into your configuration, please remember to enable the access from VSS server in the NVR's Service page.

The connection between VSS and NVR is made via encrypted https.

If the connection port is changed to a non-SSL port, the access from VSS to NVR will fail. For adding the ND series NVR, use port 443.

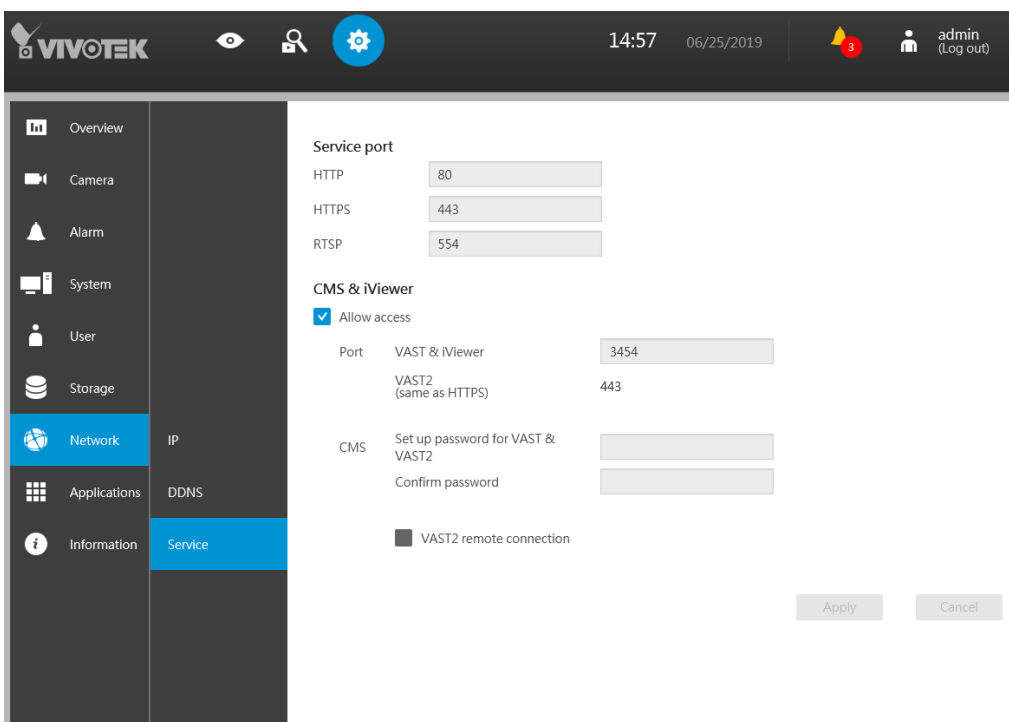

Multicasting

The VSS supports multicasting of live streams from server to clients. If multiple VSS clients demand live videos from the same camera, multicasting can help save considerable system resources.

Multicasting should be enabled on a VSS server and also on individual cameras.

There are prerequisites:

Multicasting is not supported under the following conditions:

- * A CMS local client can only access the live stream from the cameras managed by the CMS server using unicast connections.
- * If the need arises for access to cameras managed by VSS sub-stations, the multicasting configuration should take place on the sub-stations instead of on the CMS server.

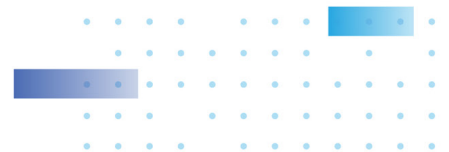
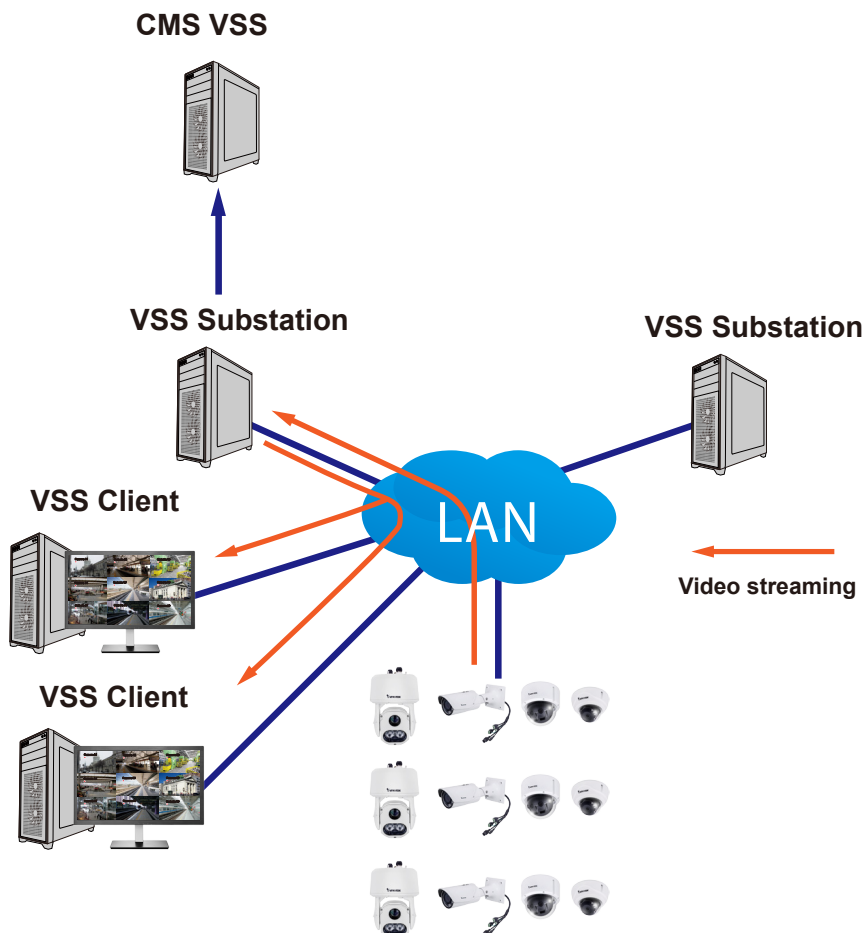

- * If the streaming connection for a sub-station is configured as **CMS Relay**, you should configure the multicasting settings on the CMS server.

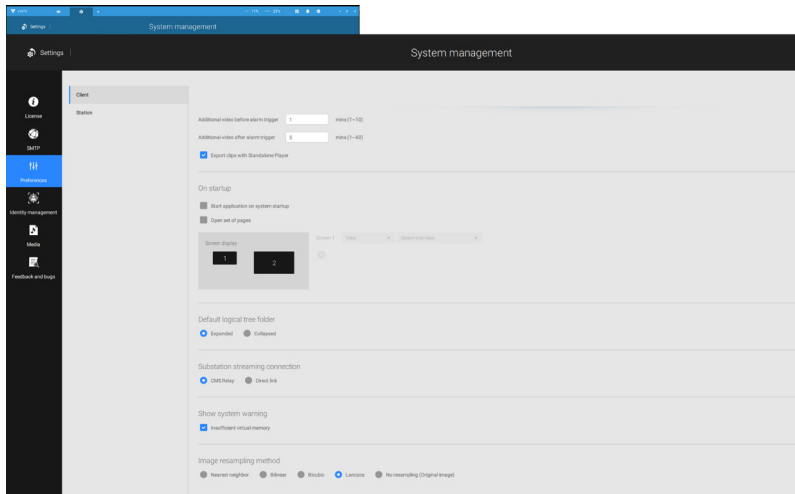

- * To enable multicasting, your network infrastructure must support the IP multicasting standard IGMP (Internet Group Management Protocol). Your server and clients should be on the the same network segment.
- * Multicasting is only possible for live streams, not applicable to the recorded video or audio.
- * Multicast streams are not encrypted, even if the the recording server uses encryption.
- * The IPv4 multicast address range is: 224.0.0.0 to 239.255.255.255.
- * A layer 2 network switch that supports IGMP is required in the configuration.



To enable Multicasting on a VSS server:

1. Enter Settings > Device > Stations.
2. Single-click to select a server for which you want to enable the Multicasting.
3. Click the checkbox to enable the configuration and enter the multicast address.
4. Click the Apply button.

Starting the Multicasting service will restart the VSS server.

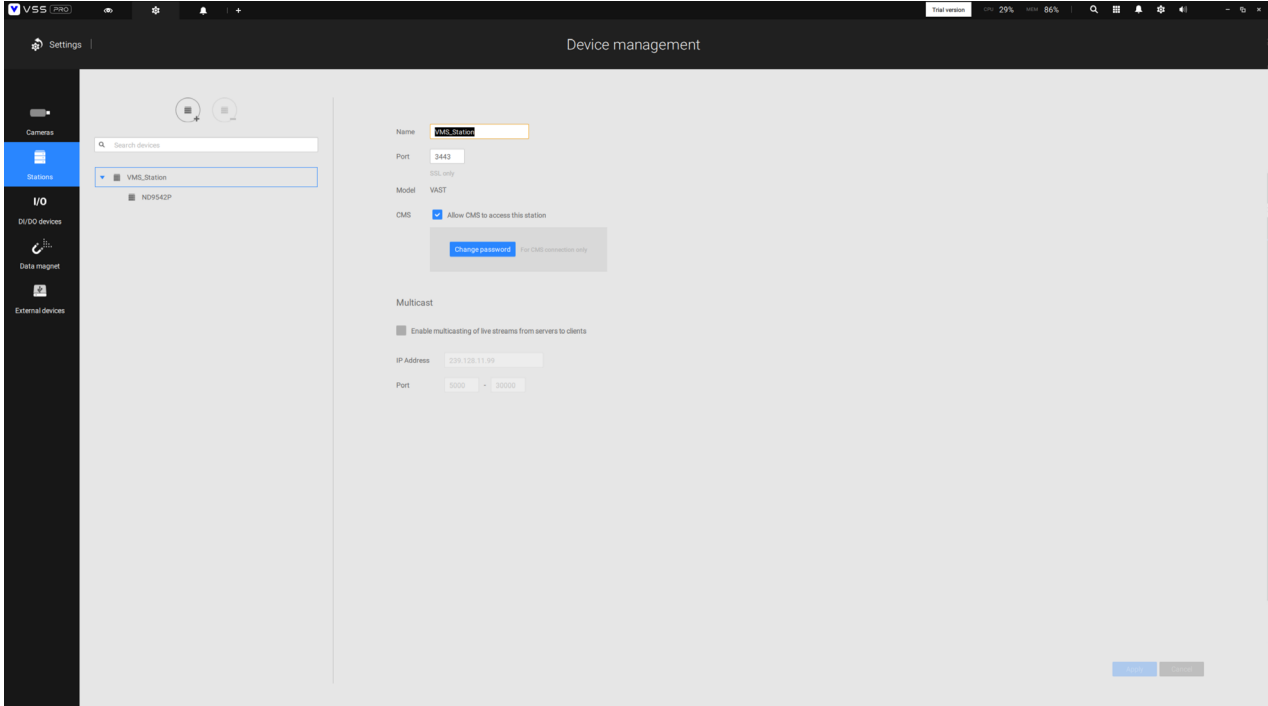

To enable Multicasting on a camera:

1. Enter Settings > Device > Cameras.
2. Single-click to select a camera for which you want to enable the Multicasting.
3. Click to select the Multicast tab.
4. Click the Multicasting slide button.
5. Click the Apply button.

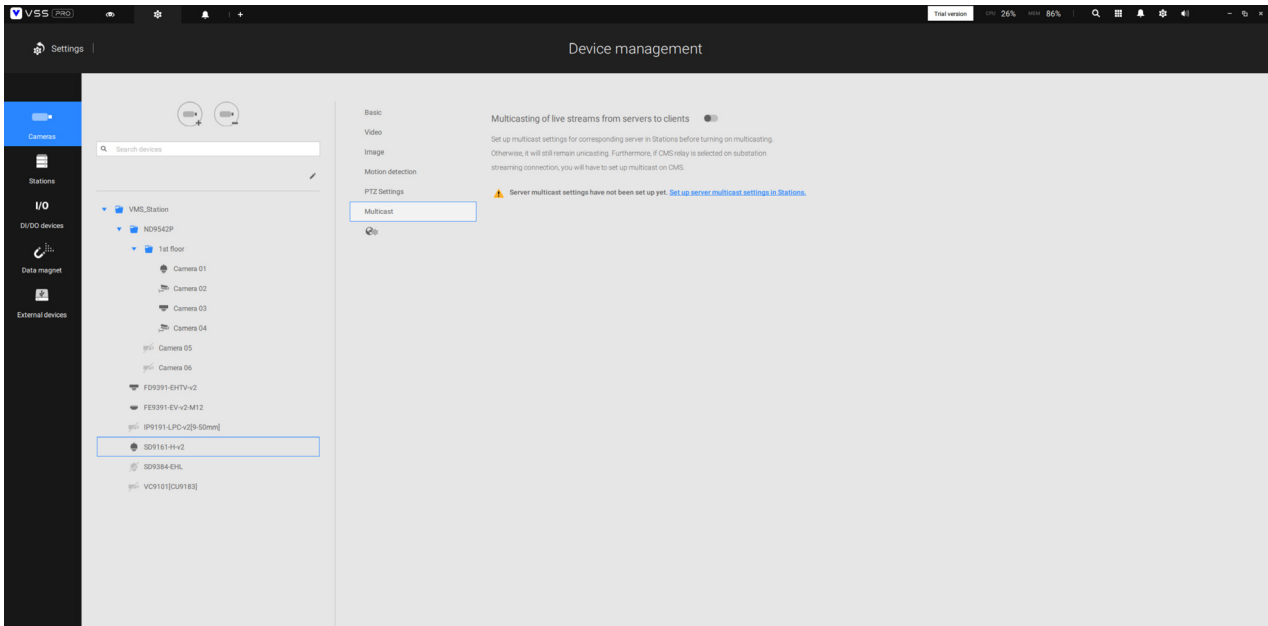

4-7. Settings > Recording > Local DB

Since some of VIVOTEK's NVRs run on Linux, you have to install the Ext2 File System Driver for Windows to access the recording files from a NVR hard disk.

The file system driver can be found here: https://sourceforge.net/projects/ext2fsd/?source=typ_redirect

Run and install the Ext2fsd-0.xx.exe. Follow the onscreen instructions to complete the installation.

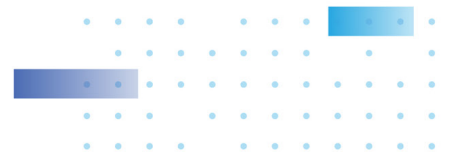
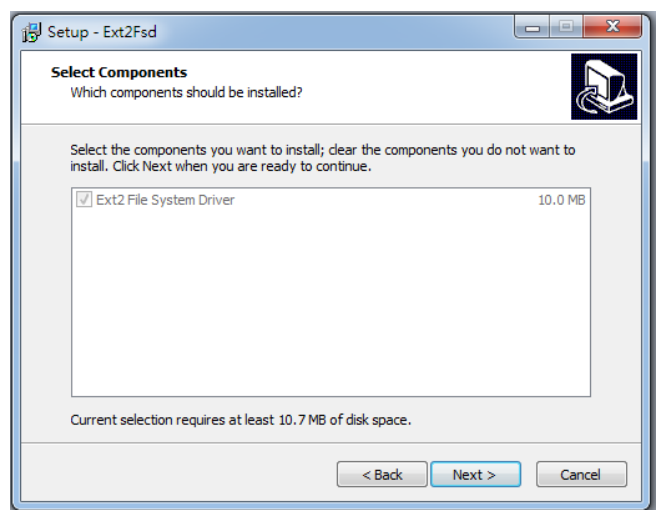
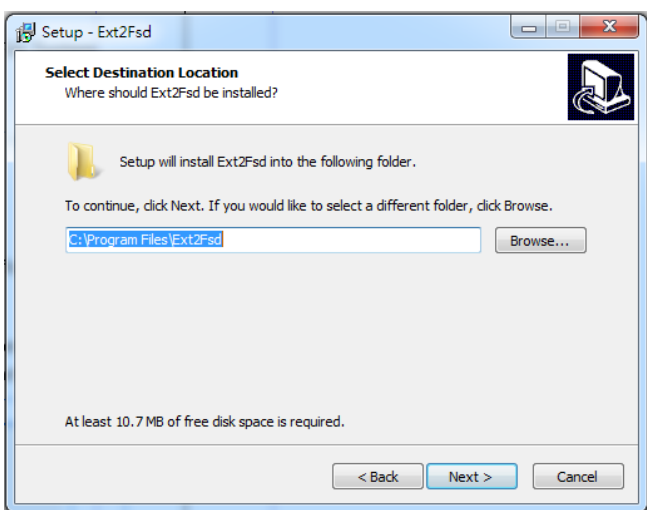

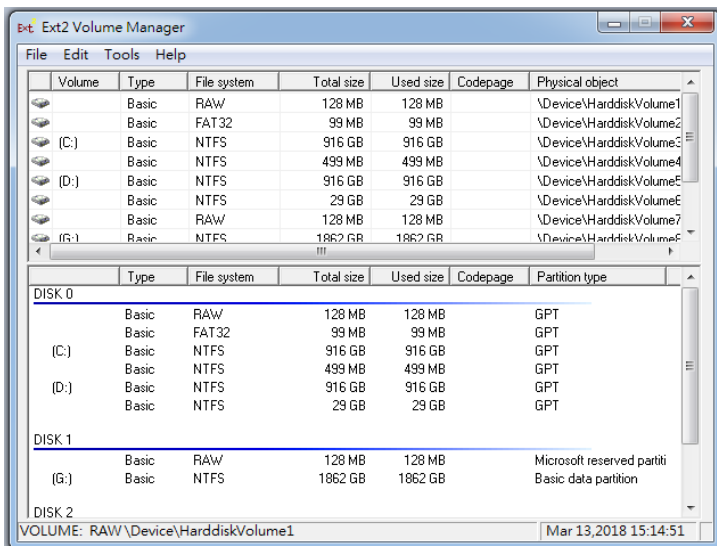
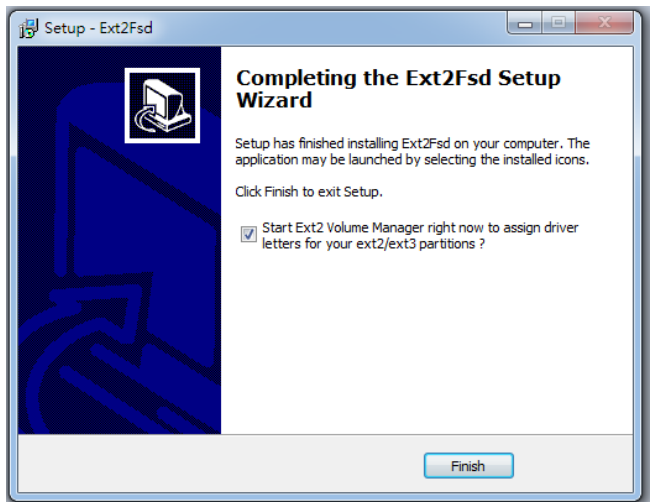
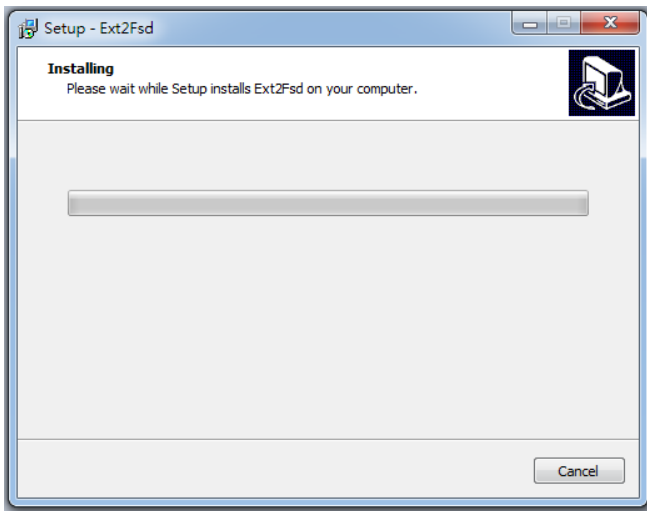
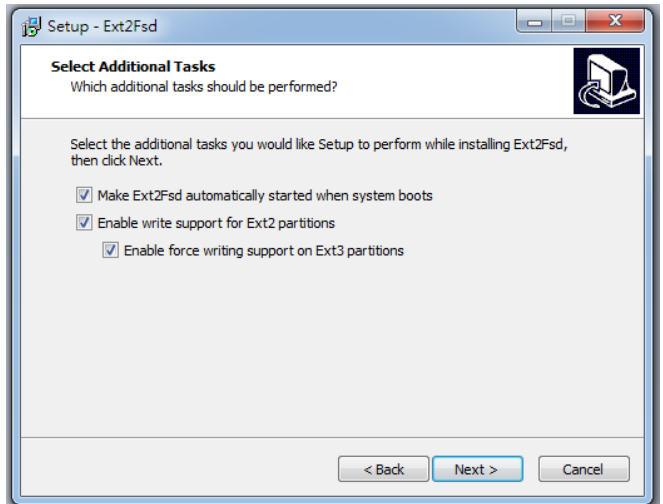
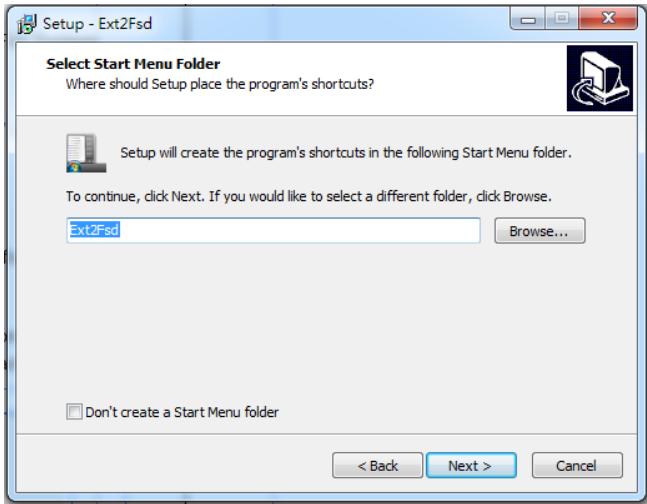

1. Remove the disk tray box from a mobile NVR.
2. Connect the disk tray box to your VSS server using a USB 3.0 type A to Micro B cable.

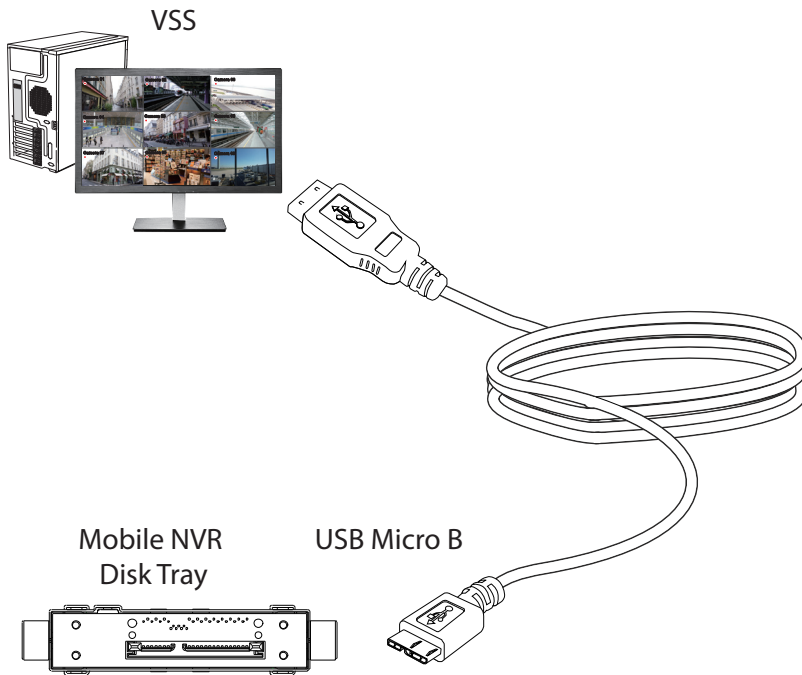

3. From VSS, enter Settings > Device > Local DB.

4. There are 3 import types:

1. **NVR disk**: the drive tray box removed from a mobile NVR.
2. **NVR backup**: the recorded videos exported from an NVR using a USB thumb disk or portable drive.
3. **VMS/CMS backup**: scheduled backup from the local machine. They include: VSS backups from previous software releases, and scheduled backups.

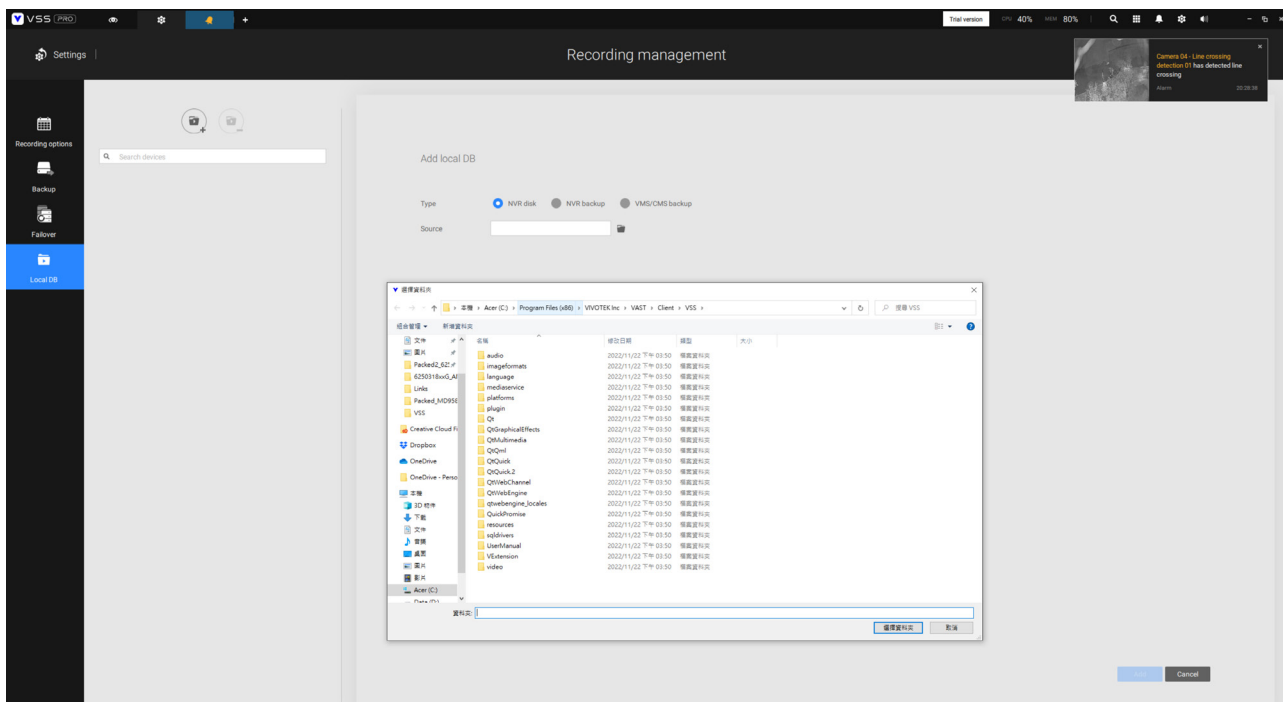

5. Taking a mobile NVR's disk drive as an example, click the  Source select button to locate the disk drive.

6. The NVR will be mounted as a local DB.

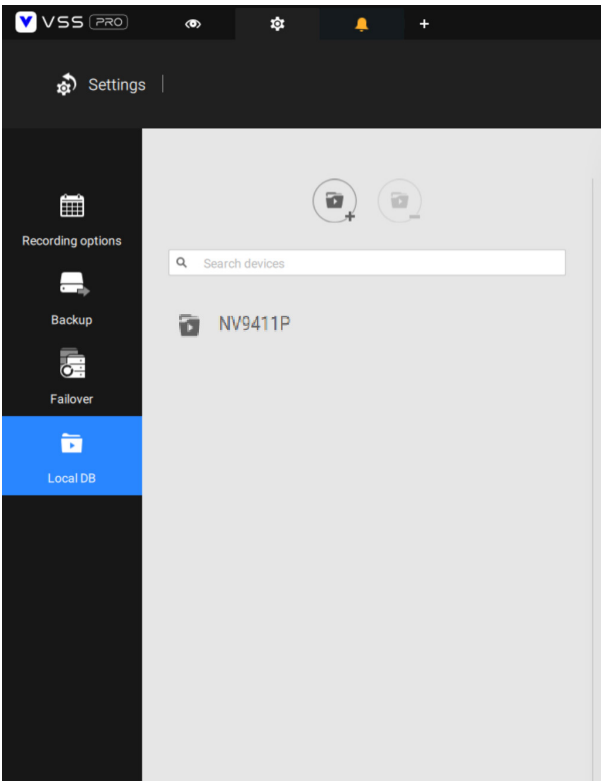

7. A Local DB sub-tree will be listed under your server, and you can view the existing recordings on the NVR's disk drive.

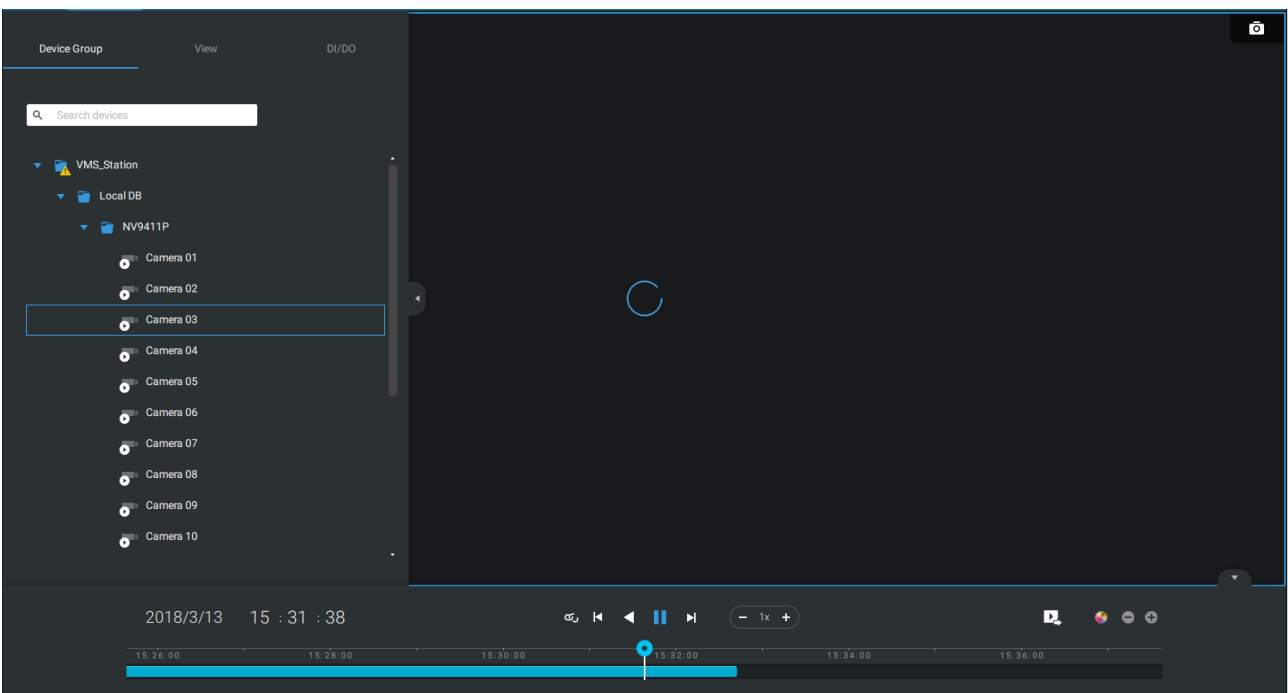

4-8. Settings > System > SMTP

Configure a mail server via which the system alarms or notifications can be delivered to a receiver.



Enter the Settings page, select . Click on the Add SMTP button.

Enter your mail server's domain name or IP address. Enter credentials for access to the mail service.

If SSL encrypted transmission is preferred, select its checkbox.

Click Add to complete the configuration.

4-9. Settings > IO Box and Related Configuration

Please refer to page 173 for information.



4-10. Settings > User Management

The User Add & Delete page allows you to create users with the permissions for different operational capabilities.

To specify the authorized privileges, select Customize in the Role menu, then select the Permissions and/or the Accessible devices tabbed menus.

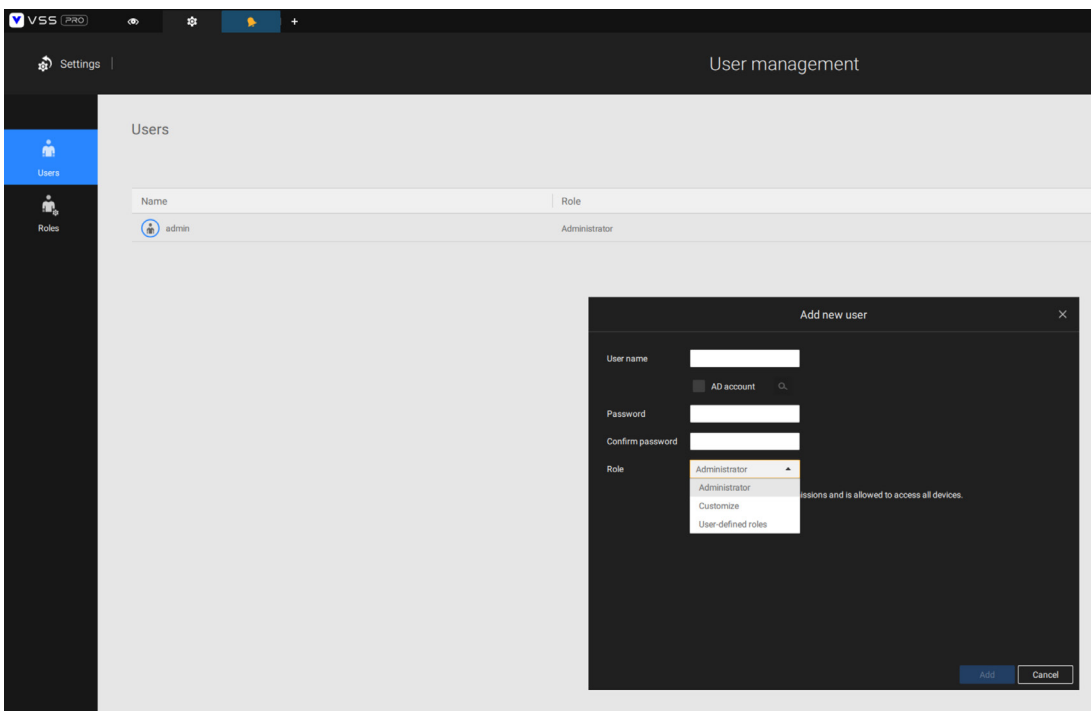

Use the Customize option to limit the authorized actions of a user.

In the Permissions tab, click the expand button  to unfold the Operation and Configuration menus. Select or deselect the checkboxes to configure the user privileges. For example, you may not want a user to operate Alarm and E-Map. If so, deselect these checkboxes.

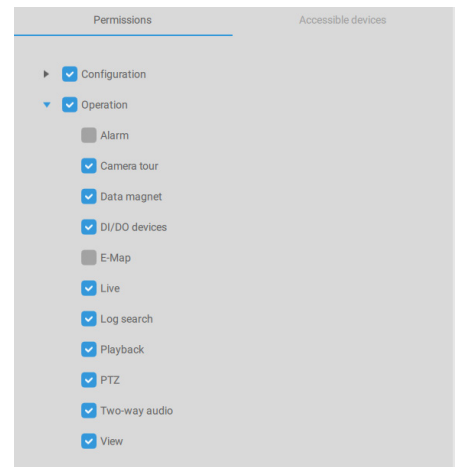

In the Accessible devices tab, click to select the cameras that a user can access. Some users may only need to access specific devices.

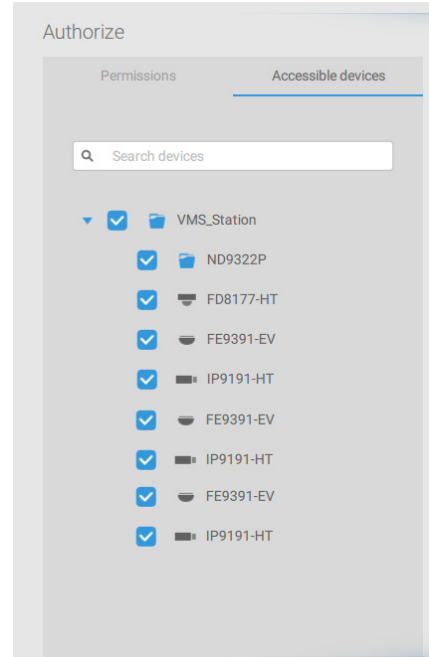

When done with the privilege settings, click Add to create a new user.

The new users will be listed under the Administrator's icon. Repeat the process to create more users.

Note that you can place a limitation on a user's access right to the recorded videos by setting a barrier for access to the older recordings. Recordings older than a configurable period of time will not be accessible.

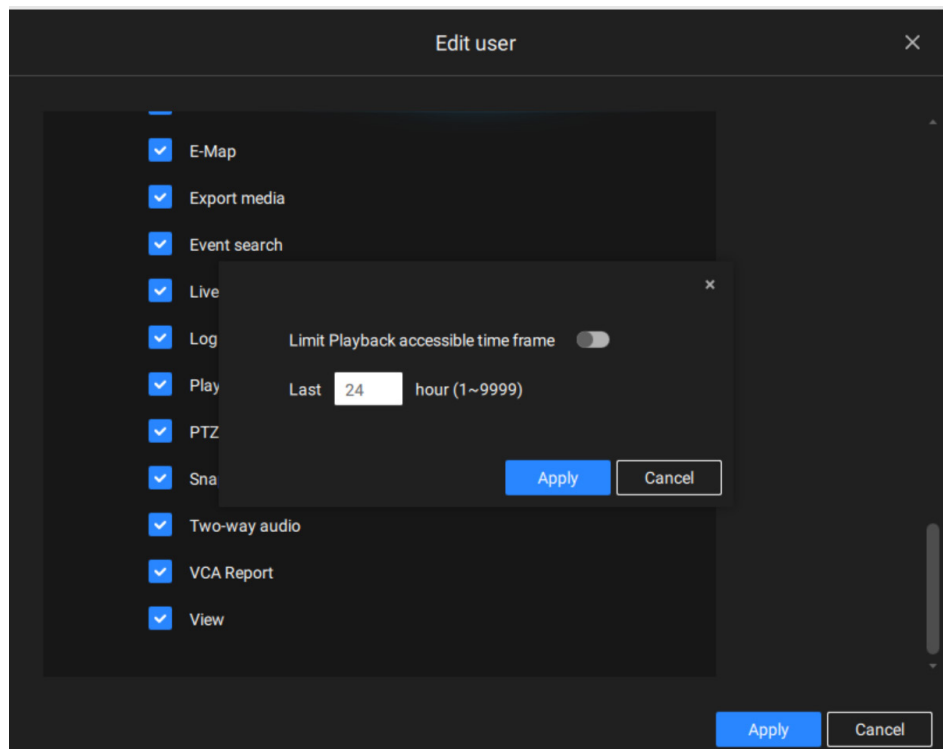

Add a New User Account - Windows AD Account

In an established, enterprise network environment, the support for Windows AD (Active Directory) infrastructure enables ease of integration using the credentials of existing users. Using the same AD authentication methodologies, you can configure the clients or users in an established network to access the VSS server configuration.

Note the following with Windows AD support:

1. If you install VSS server on a Windows XP machine with Postgre SQL server, the login using a Windows AD account will not work.
2. The VSS server must reside in a domain managed by the AD server.
3. This function does not support the environment that spans across multiple AD domains.
4. A user account hosted by an AD server cannot be modified in VSS.
5. A User Group and its members configured in AD cannot be managed in VSS.
6. You cannot add an account having the same name as one you used to log in VSS.
7. There are 3 types of account for VSS: VIVOTEK account, AD single user, AD group.
8. The userPrincipalName of your Windows AD account can be different from the sAMAccountName. However, You can only use the sAMAccountName to login VSS.
9. The userPrincipalName field of your Windows AD account should not be empty.

To add an existing AD user,

1. **Select the AD account checkbox.**

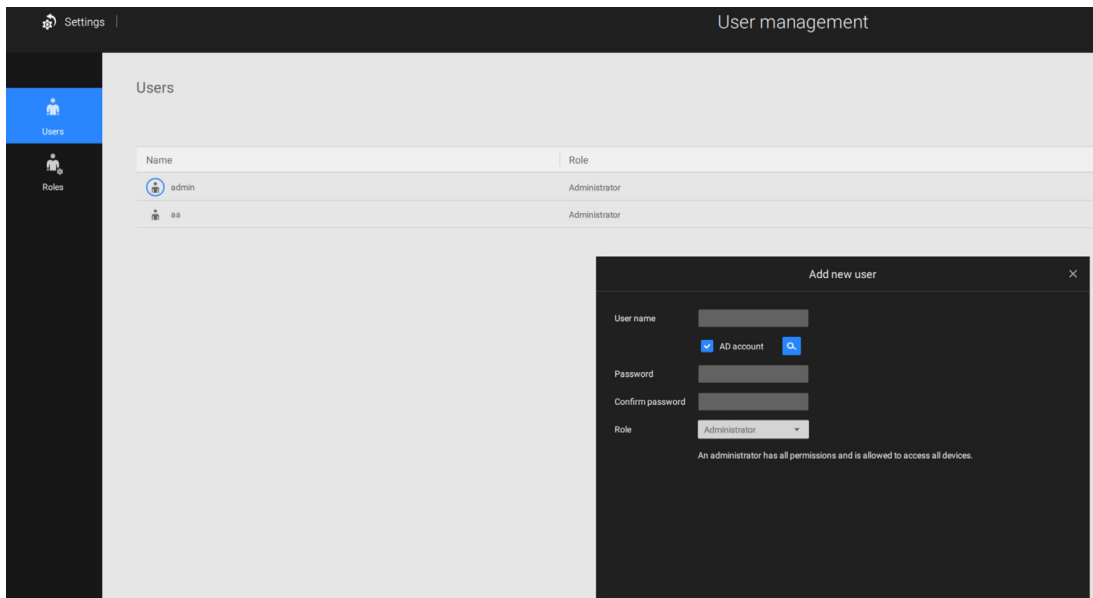

2. **Click the Search  button.**



3. Enter a user name or group name to search, e.g., Frank. Click OK when done.

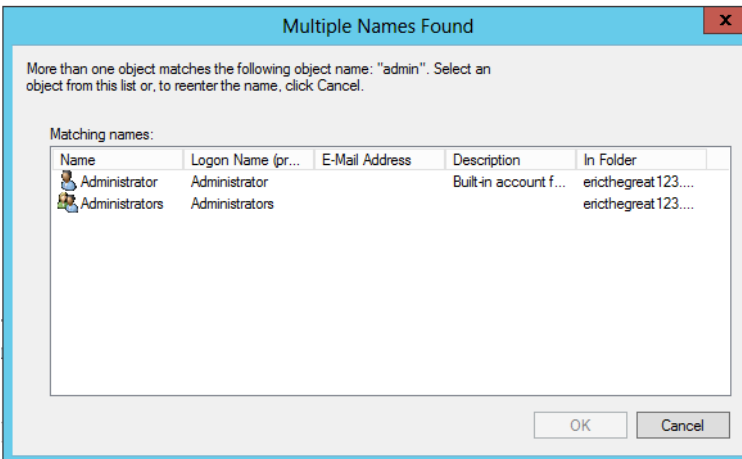
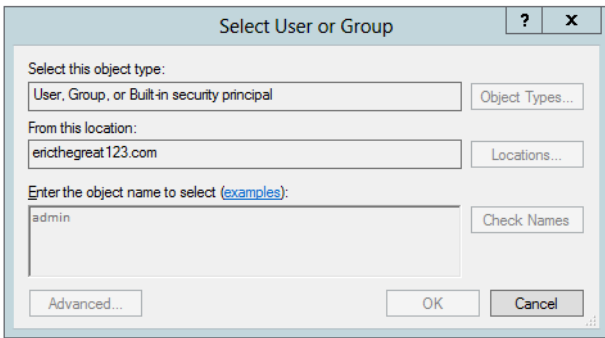

4. Enter the password twice for the AD user.

5. Select the privilege role for the user, configure his/her privilege settings as described above and then click Add.



User Roles

A user-defined role allows you to define a common set of permission a for group of users, reducing the setup time for different groups of users.

You can specify the role name in the first column. Also, you can select existing users for this new role. Note that once the users are selected for a new role, it will change its role and corresponding authorities. Each role can be assigned with the permissions and accessible devices like customized settings in user accounts. Users can select more than one role and have the unified settings for all roles' permissions.

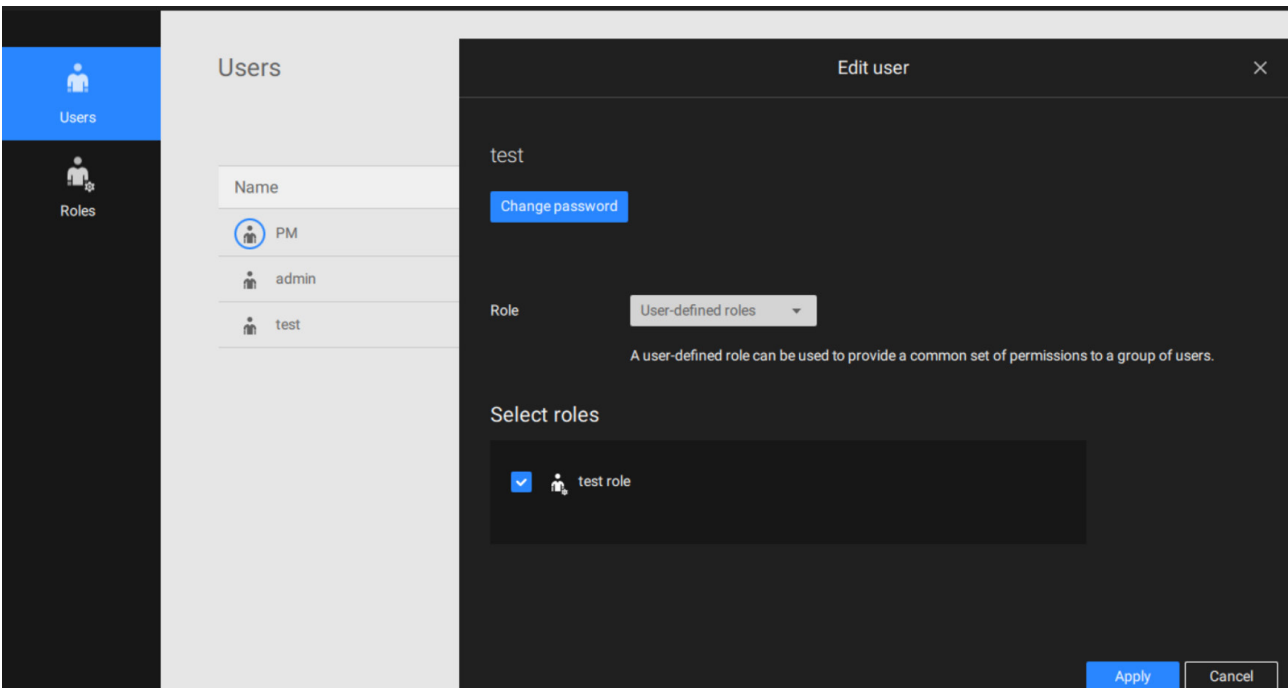
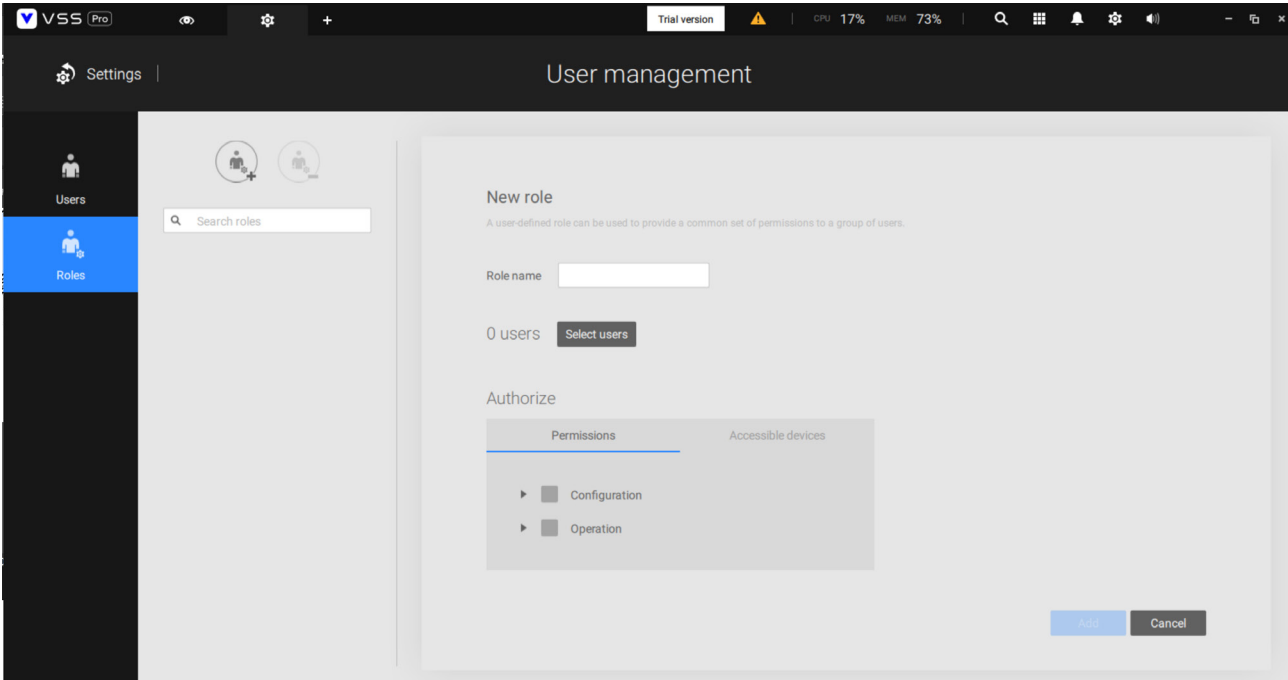

4-11. Settings > VIVOCloud

If users have an existing VIVOCloud account, they can join their current configuration with VSS, such as an NVR and the cameras managed by it.

The precondition is, you must allow the NVR to be accessed from a VSS server. Open a console to the NVR, and enter IP > Service, to click on Allow access.

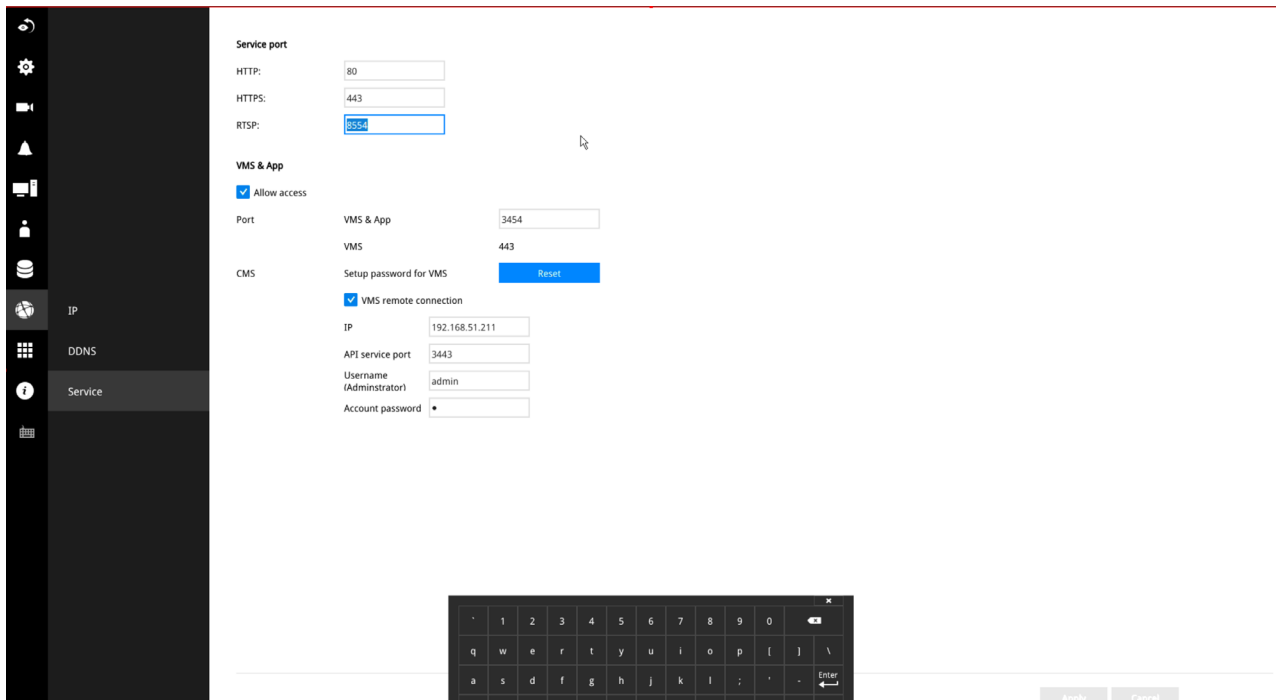

On the VSS client, click Settings > VIVOCloud.

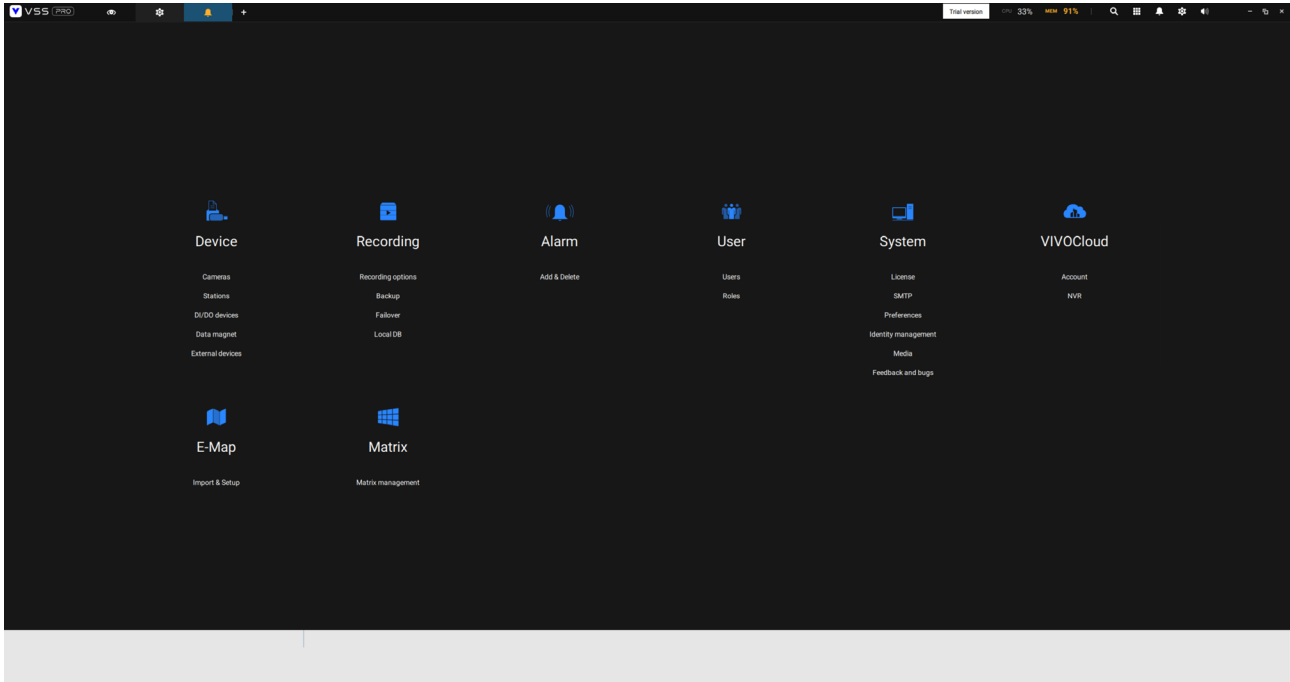

Log in using your VIVOCloud credentials.



The NVR will be listed under the VIVOCloud device tree.

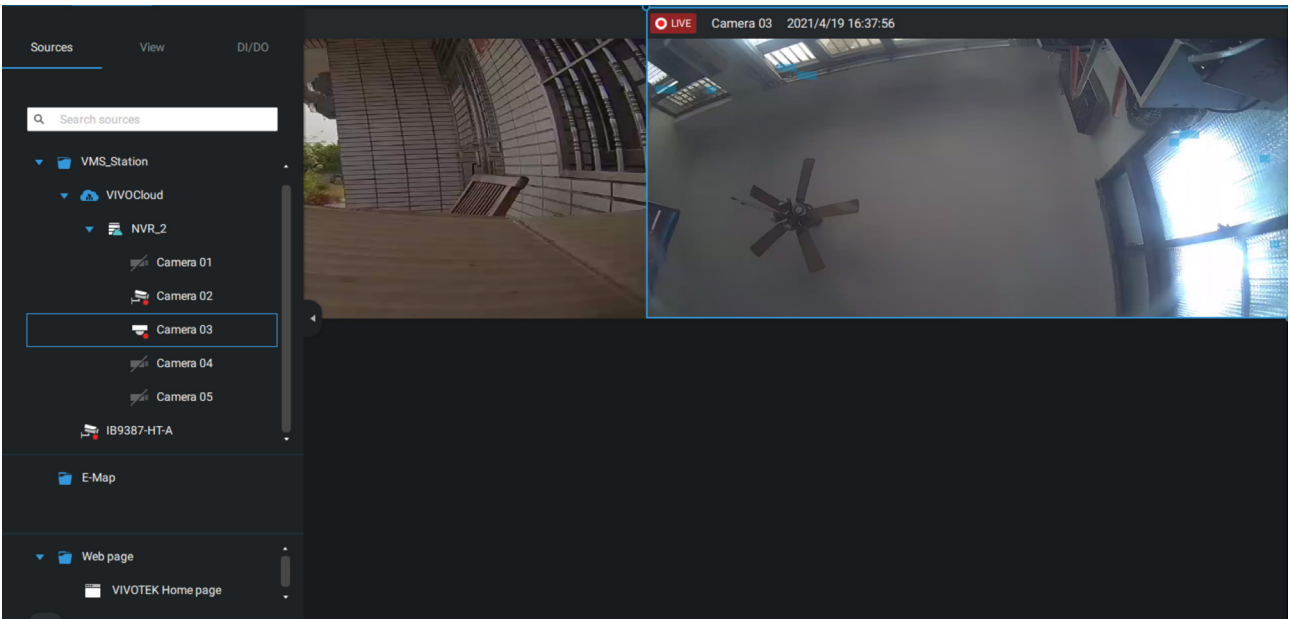
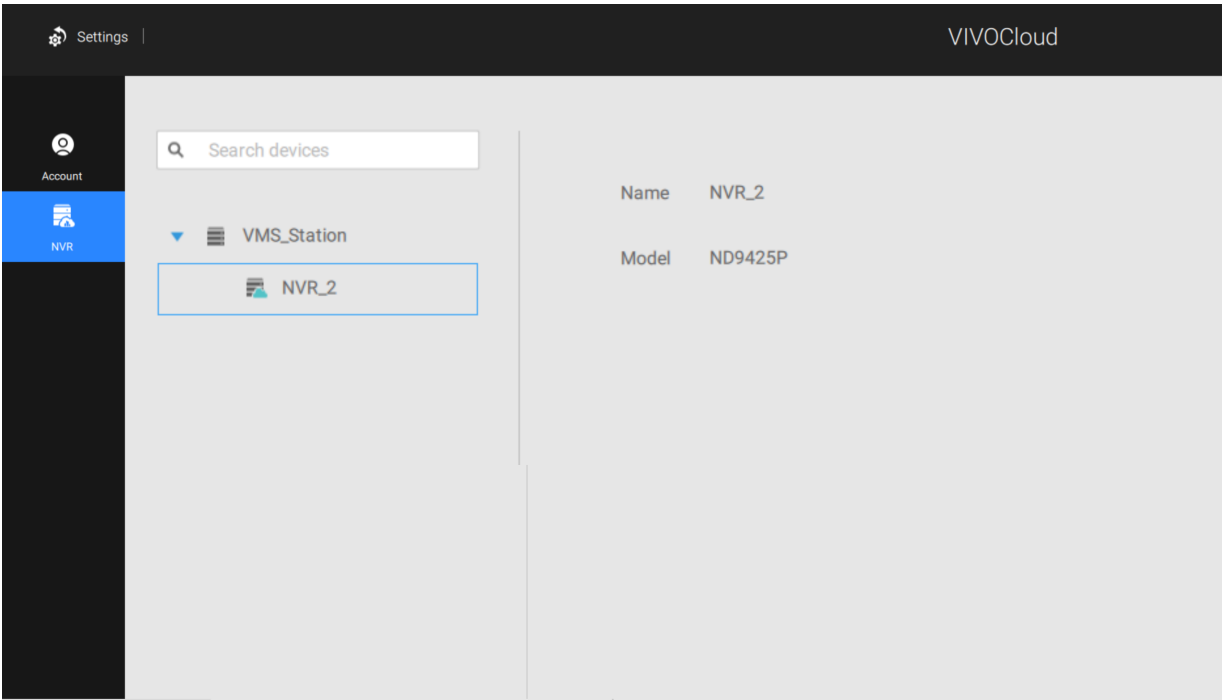

If the NVR managed through the VIVOCloud is connected via a local or P2P network, the connection should be normal. If the NVR is connected through VIVOCloud Relay, a 28 minutes timeout will be imposed, and you can use the connect button to re-connect.

You can encounter this message with connection problems or you did not allow the access from a VSS server. You have to log out your VIVOCloud account and log in again after you solve the above problems.

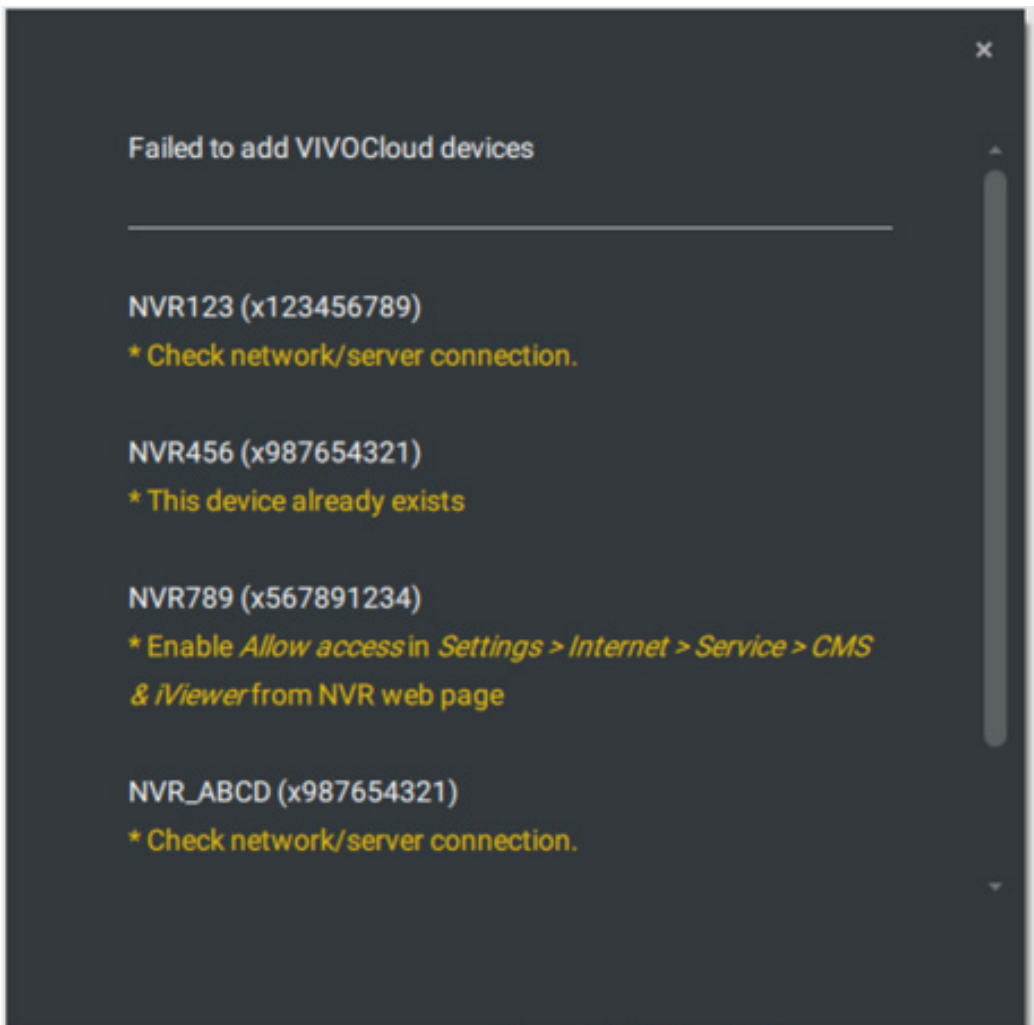



Appendix A: VSS Service Control Tool

VSS service control tool is a tool for server control and for user to be aware of the VSS Server status. It starts up as Windows OS startup.

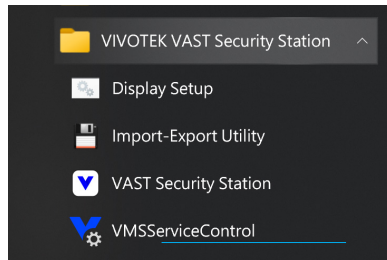
Under Microsoft Windows, choose "Start > All Programs > VIVOTEK Security Station > VMServiceControl."



You may also find it in the system tray icon of the tool bar, which indicates that the service is running: 

It shows a disconnection icon when the service is stopped: 

A menu for the service control tool will pop up when you right-click on the icon:

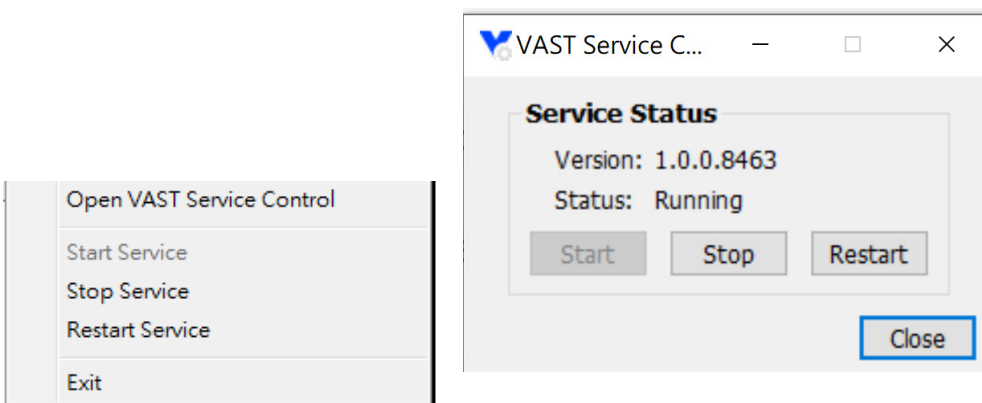

Here you can manually start, stop and restart the service.



Appendix B: Matrix

The virtual matrix feature enables the display of any cameras on any monitors in an IP surveillance network. Combinations of live or playback streams can be displayed simultaneously. In addition of pre-configured live views, E-maps, Google maps, and Alarm panes can all be placed on a remote matrix. Users gain realtime awareness of scenes and access to past events.

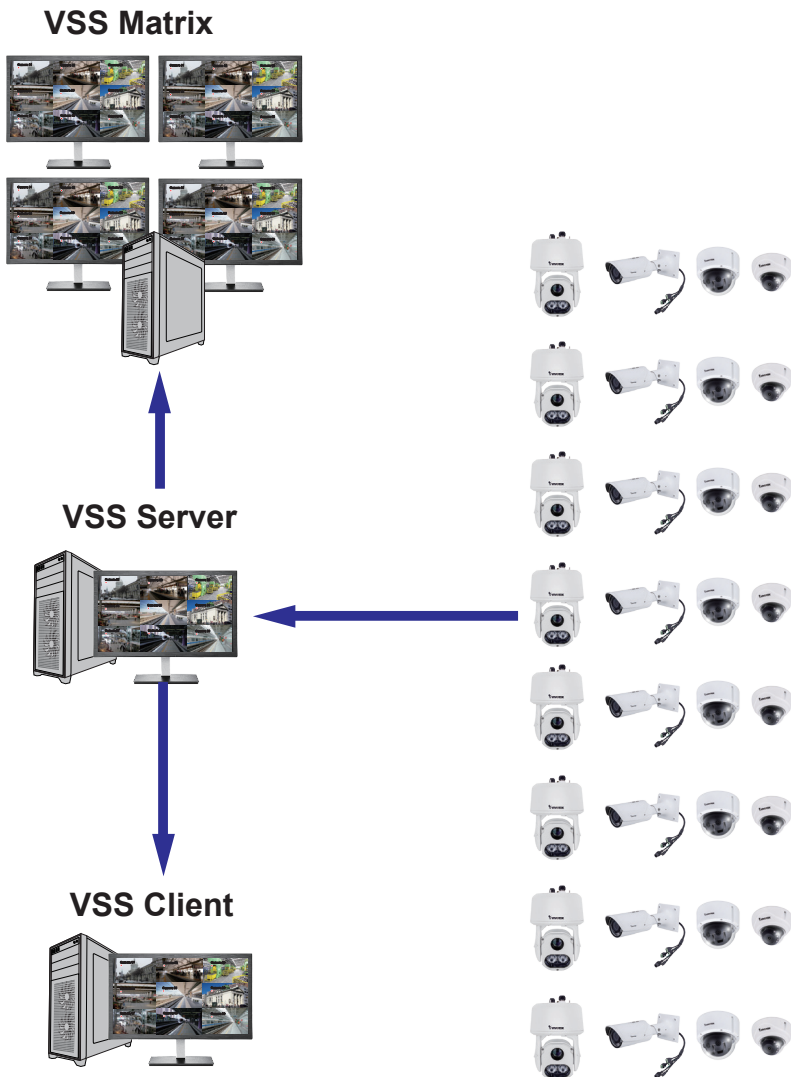

Prerequisites:

1. One VSS server and another computer running the Matrix client utility.
2. The first 2 digits of software revision numbers of VSS server and Matrix client must be the same: e.g., 2.3.x.x and 2.3.x.x.
3. Sufficient network bandwidth among network cameras, VSS servers, and Matrix clients.

Configuration procedure:

1. Install the Matrix client utility on a computer equipped with multiple monitors. Follow the onscreen instructions to install the utility.

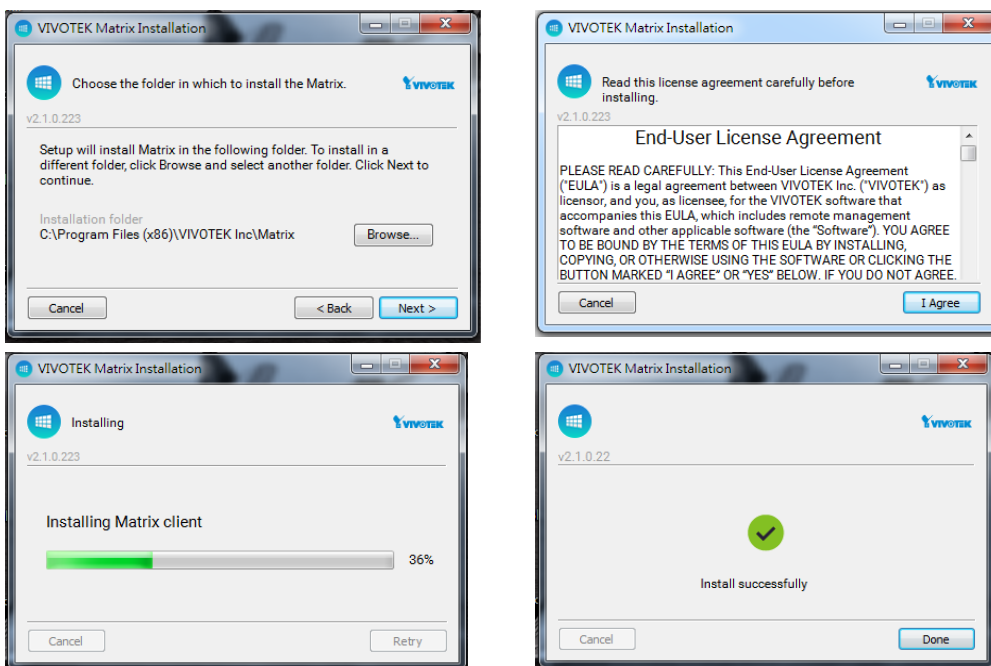

2. On the VSS server, create a user account for the Matrix client. Depending on the operation on the client computer, assign the client user with adequate operation privileges.

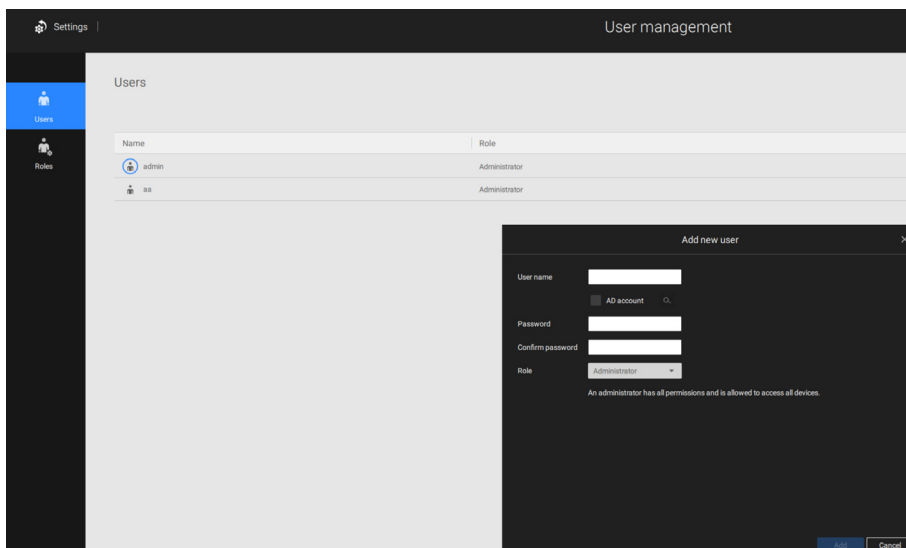

3. Open the Matrix utility, log in to the VSS server address, using the Matrix client account credentials.

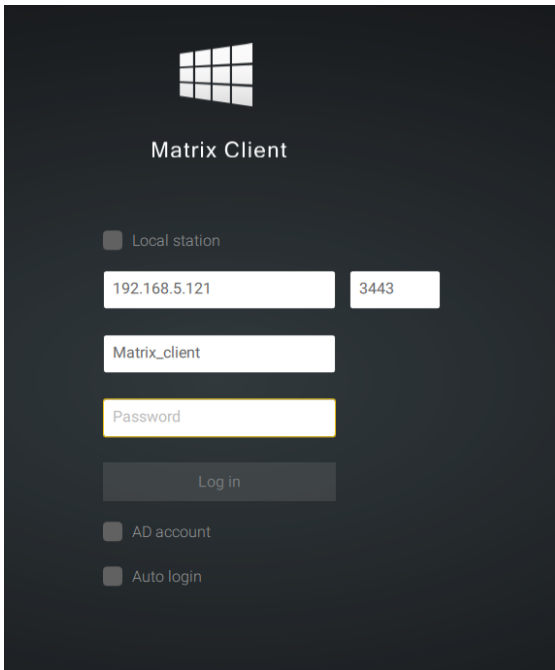

4. From the VSS server, open the Settings > Matrix Management window.



5. Enter the name of your Matrix client, e.g., Matrix_client in the search pane of the Matrix Management window. Note that the Matrix client must have logged in to establish the connection before the VSS server can find it (as previously described).

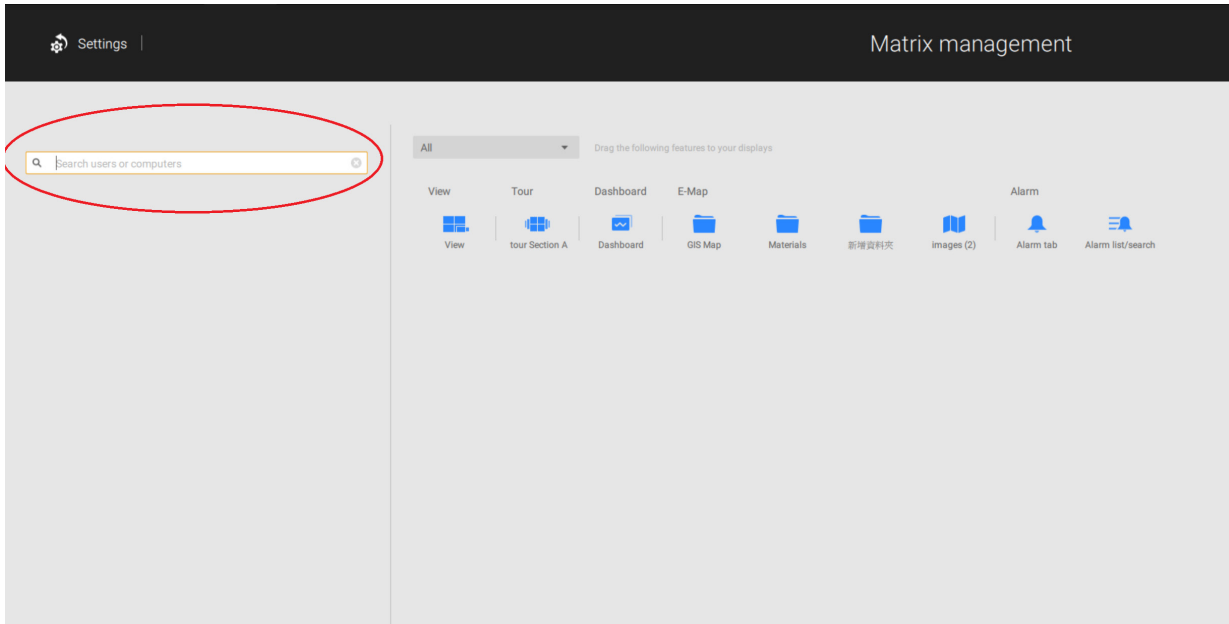

6. Once the VSS server finds the Matrix client, the available monitors will be listed. Click and drag the pre-configured Views, Tour, Dashboard, E-maps, or Alarm panel to any of the monitors.

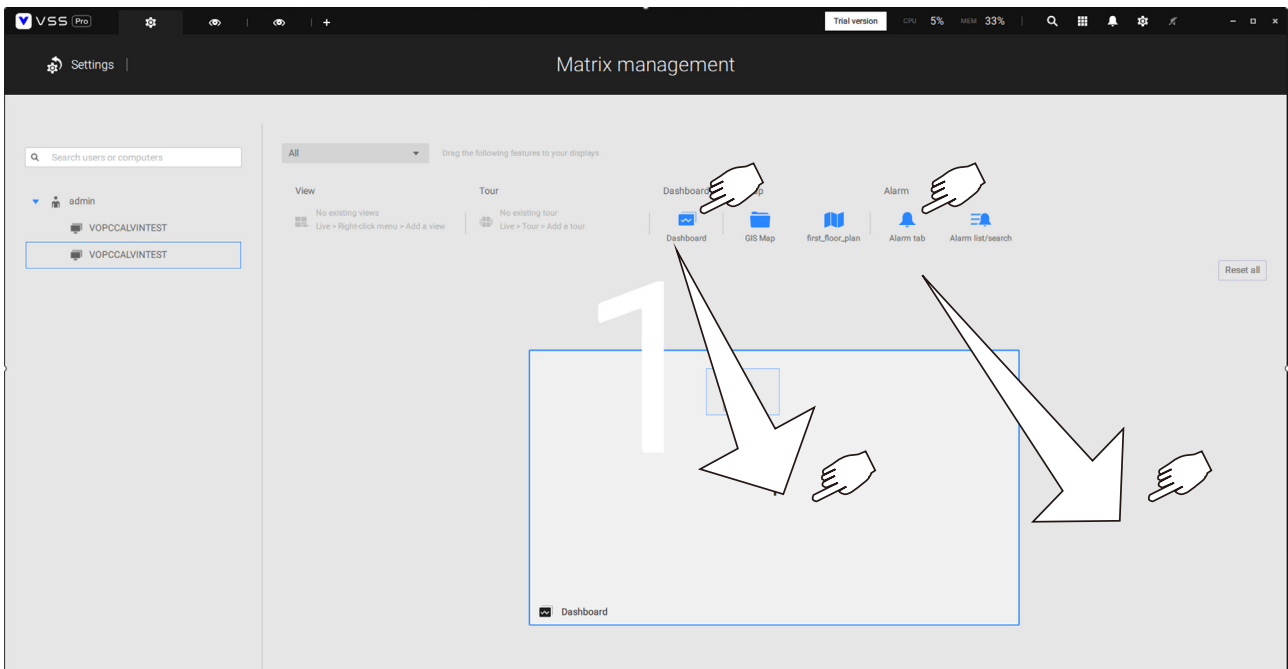

7. The views should immediately appear on the Matrix monitors.



8. If you need to log out, move your mouse cursor to the top of the Matrix client screen to end the session.

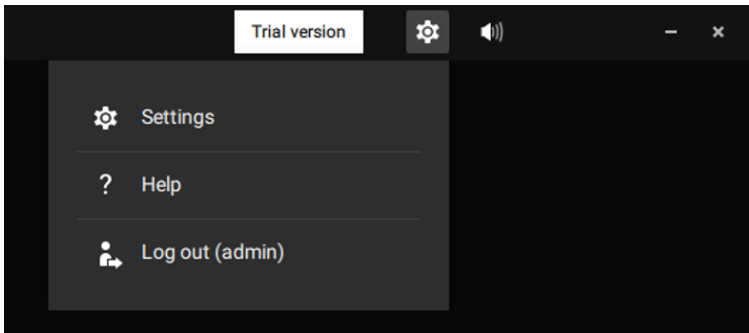

If necessary, change your client settings. Here you can change the displayed language, Export target folder, Start-up option, and the streaming connection options.

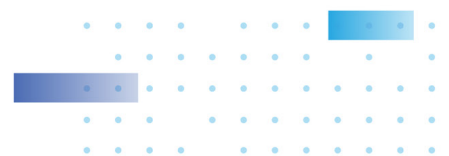
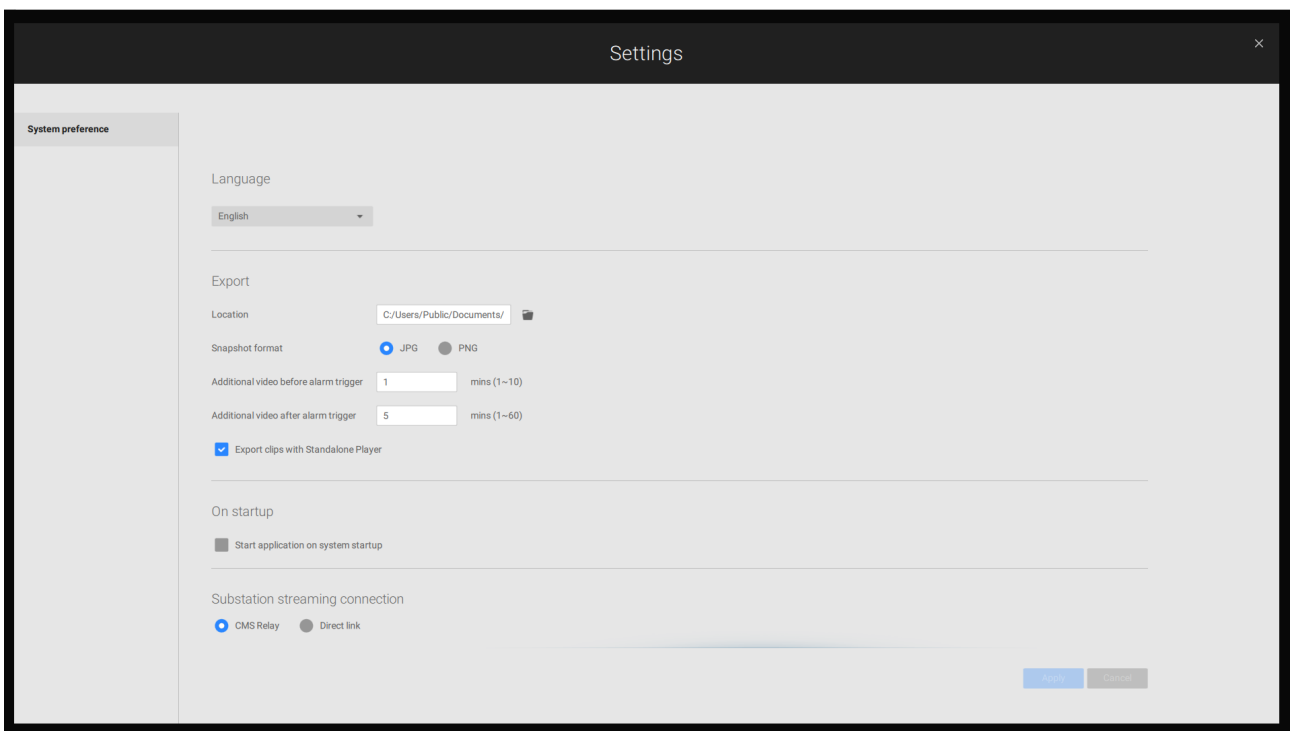

Appendix C: Joystick Support

Configurable joystick buttons

1. Connect the joystick's USB cable between the USB ports on the joystick and a VSS server/client.
2. Once connected, you should be prompted by a connection message.

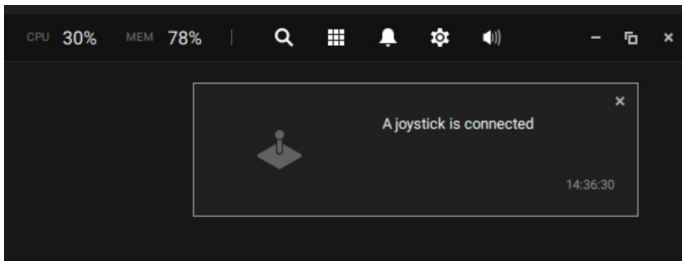

3. Enter Settings > Device > External devices.
4. Single-click to select the detected joystick. The configurable buttons will be listed. Click ▶ to expand the Live, Playback and Common menus.

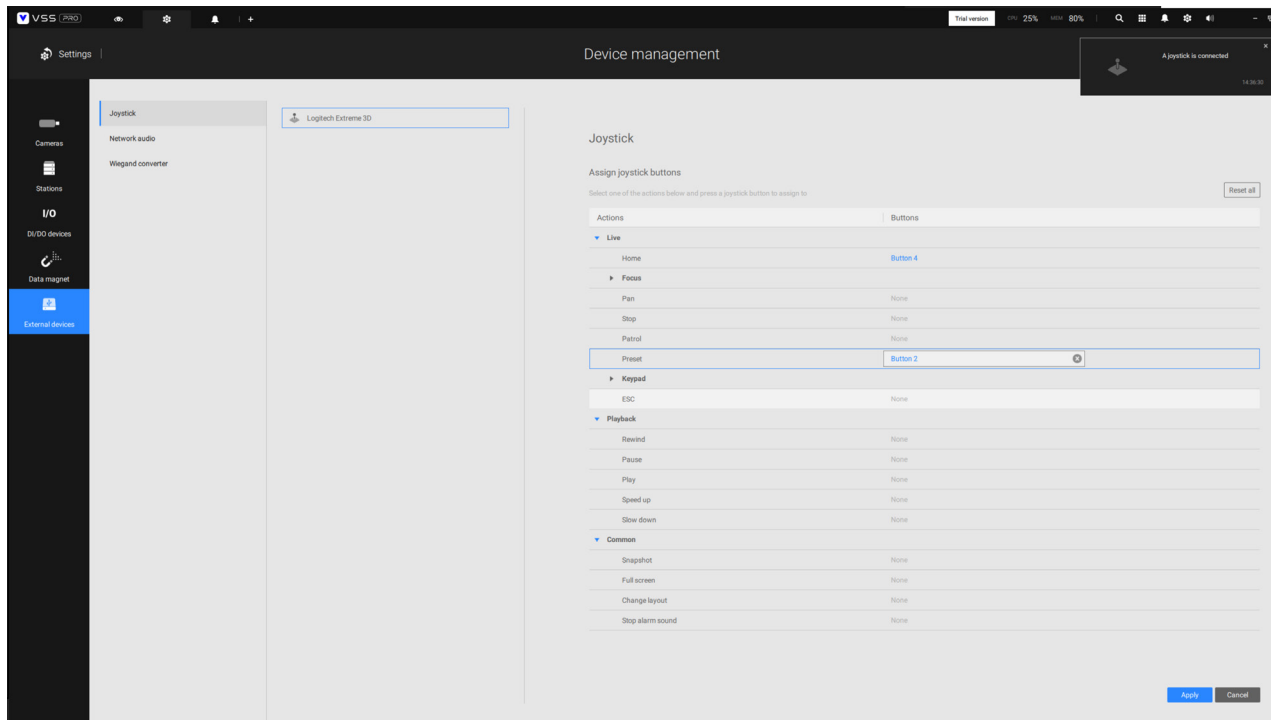

5. To assign or re-assign a button's function, single-click on the button number besides a function. Click the Delete  button. The below message will display.

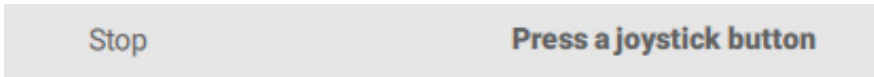

Press a preferred button on your joystick to complete the setting.

If a button conflict occurs, (another function has already been assigned to the same button), the below message will prompt. You can Cancel or click Apply to change the assignment.

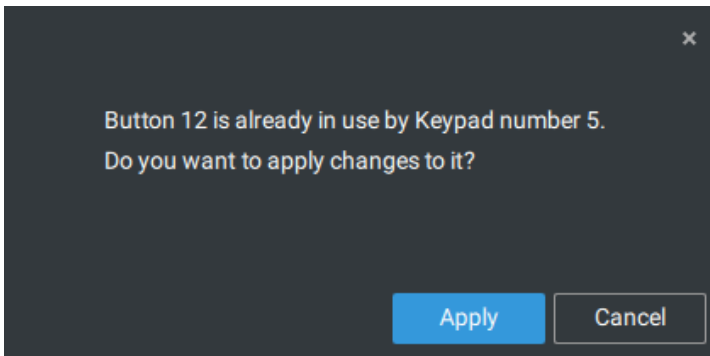

Repeat the above process and click the Apply button to preserve your settings.



VIVOTEK's joysticks

The AJ-002 is a USB joystick with HID 3-axis PTZ control, a twist wheel for zoom in/zoom out, and 29 configurable function buttons for use on a VSS server station.

Following are the conditions for making the connection:

1. The joystick can either be powered by a DC 12V adaptor or via the USB. If powered by USB, plug the USB cable twice to the USB port to enable USB power.
2. Connect the included USB cable between the USB ports on the joystick and a VSS server station.

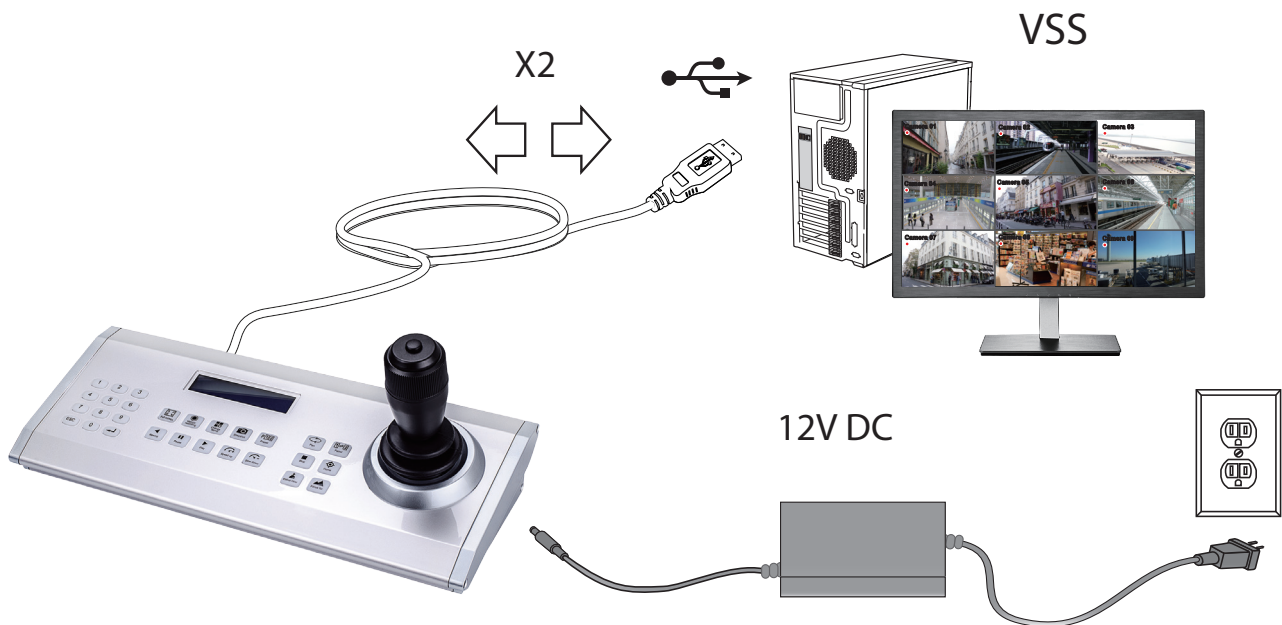

NOTE:

1. Avoid spilling water onto the device. Avoid using this device in a high-moisture environment.
2. This device should be operated in the indoor environment.
3. When the temperature is lower than -10°C , the LCD panel may not function normally.
4. If the included power adapter should be replaced, use a 9-15V/1000mA alternative.
5. Avoid impact to the device.
6. This product is manufactured to comply with the requirements of the following directives:
89/336/EEC, 92/31/EEC, 93/68/EEC.



KEYPAD DEFINITION

Below is the keypad numbering sequence:

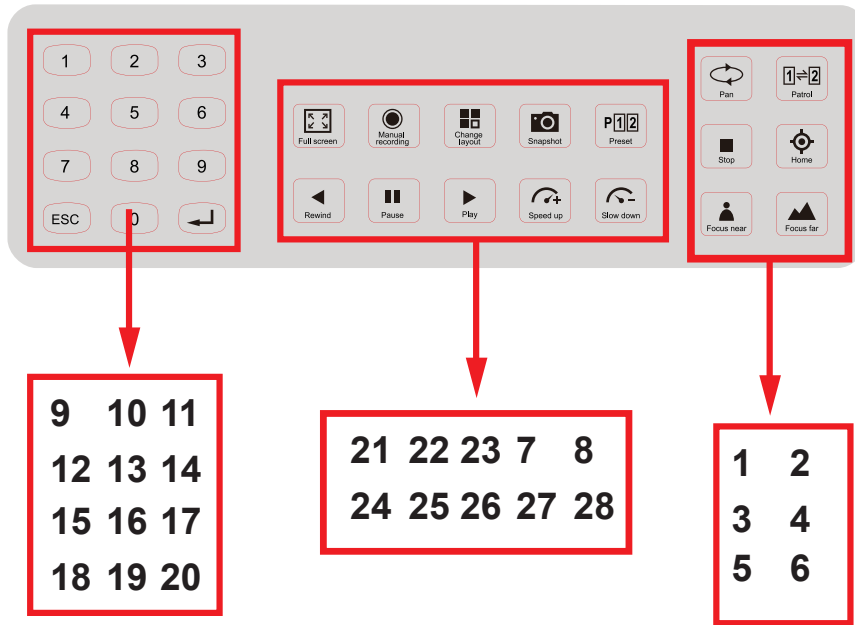

The following keypad functions will be available as the defaults for the joystick.

1	Pan	9	#1	17	#9	25	Pause
2	Patrol	10	#2	18	Cancel/Clear/Esc	26	Play (Playback)
3	Stop	11	#3	19	#0	27	Speed Up
4	Home	12	#4	20	Enter	28	Speed Down
5	Focus Near	13	#5	21	Full Screen		
6	Focus Far	14	#6	22	Manual recording		
7	Snapshot	15	#7	23	Change Layout		
8	Preset	16	#8	24	Rewind		

When a joystick is connected, the VSS server should automatically detect the connection.

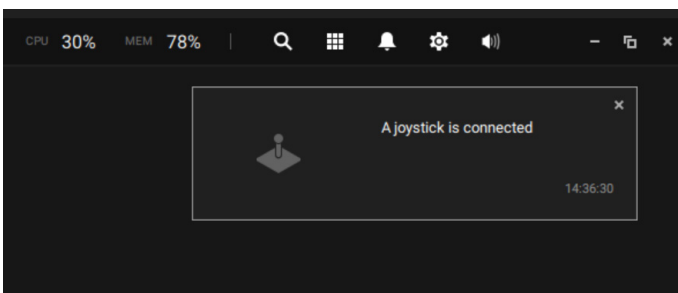

The following controls are available:

- * PTZ control – Basic PTZ control: Direction, Home, Zoom in/out, and Focus near/far.
- * Playback control – Play, Pause, Stop, Rewind, Speed up and Slow down.
- * View switch – Switch to existing View (Users need to create views first).



Left-click to select your server on the device tree, and right-click to display and select the "Show joystick key number." The camera key numbers are determined by the sequence when the cameras were added to the VSS configuration, and cannot be changed. By default, the key numbers are not shown.

Press the key number on the joystick keypad and the Enter key ↵, e.g., 5 + ↵. The full view of the selected camera will display.

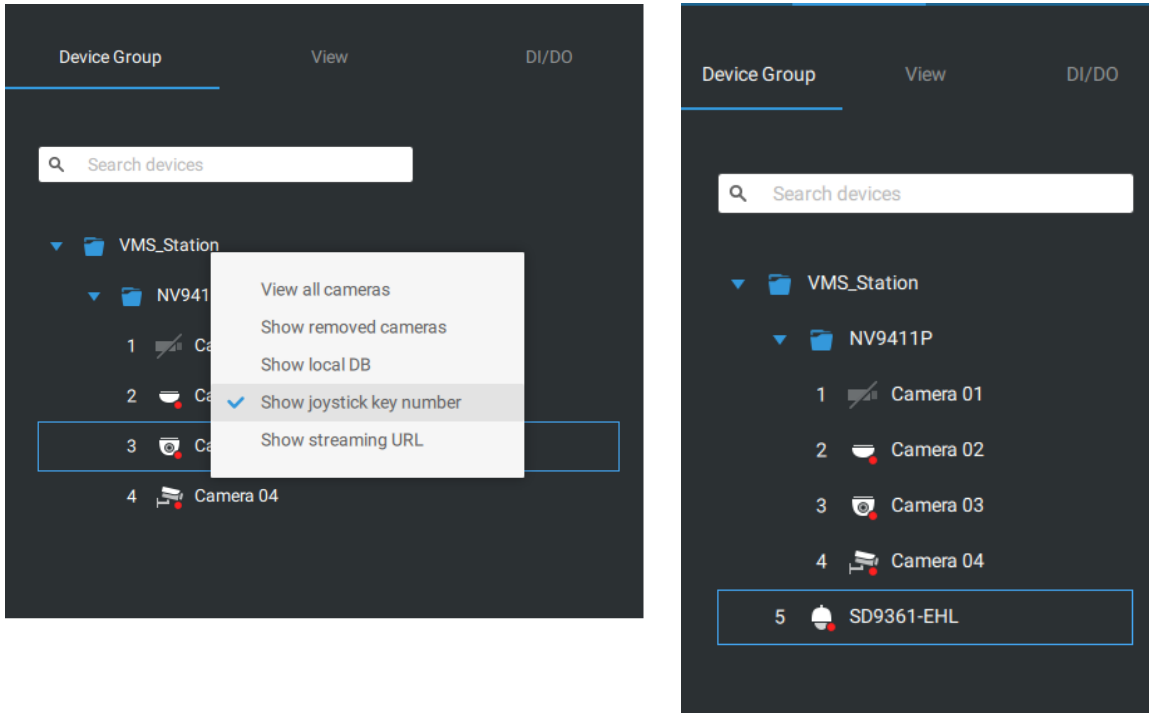

Press the ESC key to leave the full view.

To move to a preset position, press the number key + Preset, and the Enter key ↵. The number key corresponds to the sequence number for the preset position regardless of the name of the preset.

Note that the RS232/485 terminal connection is currently not supported.

Note that the Manual Recording button is currently not effective.



If you have multiple views, press the number key and the Change Layout, and the Enter key

← to switch to a different view. The number key corresponds to the sequence number for the view you configured regardless of the name of the view (layout).

The Play button toggles the playback window. From here you can trace back the past recordings. You can use speed up, slow down, and rewind buttons here. Once the Playback mode is toggled, the point-in-time defaults to the start of the current hour.

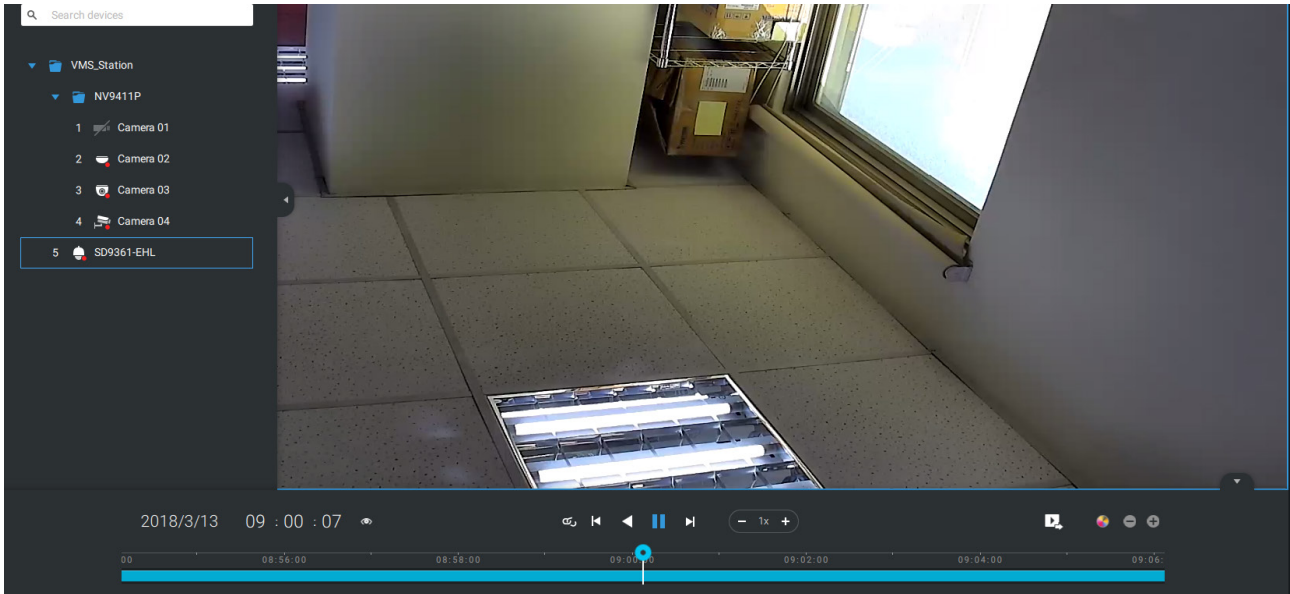

Appendix D: Network Audio Solution

You can add network speakers to your workstation in Settings > External Devices > Network Audio.

1. Connect the network speaker to a local network.
2. Once connected, enter its IP address, User Name, Password, Port number (default is 5060).
3. You can associate one network camera with the speaker.

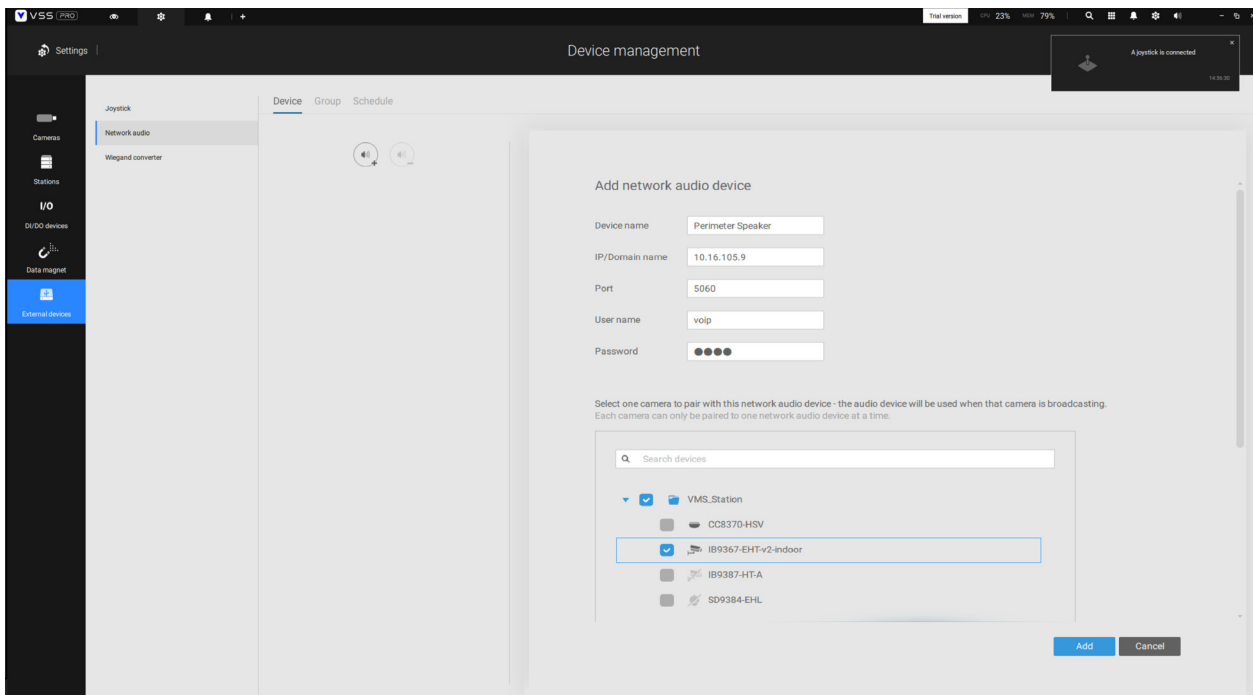

4. You can use the Broadcast function on the right of the screen to test the connectivity.
5. You can right-click on the live view to find the Broadcast function to speak or broadcast a audio clip.

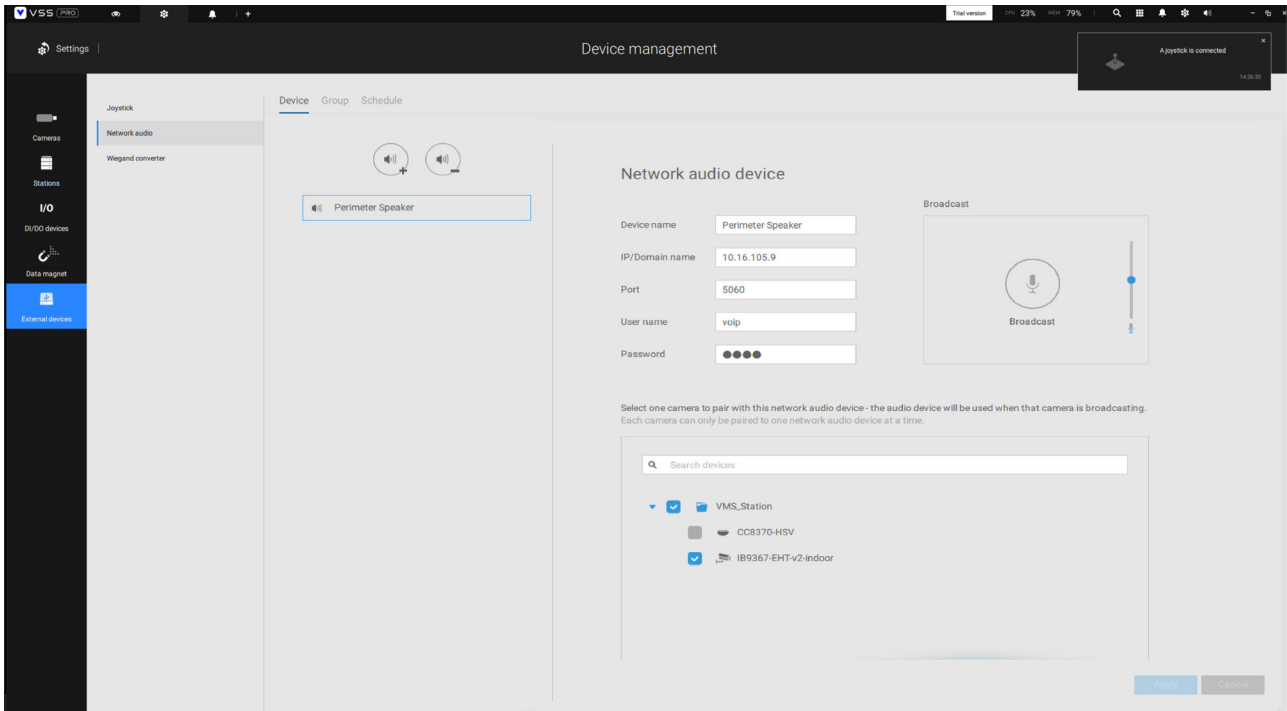

6. On the occurrence of a triggered alarm (Motion or VCA event), you can configure the alarm settings so that system can broadcast an audio clip. Configure audio clip settings in System > Media, and select "Play audio file with network audio device" in the Alarm action page.

Note that the pre-recorded audio clip should be uploaded from System > Media. The supported audio file is WAV: 8Khz, Mono, 16-bit, PCM.

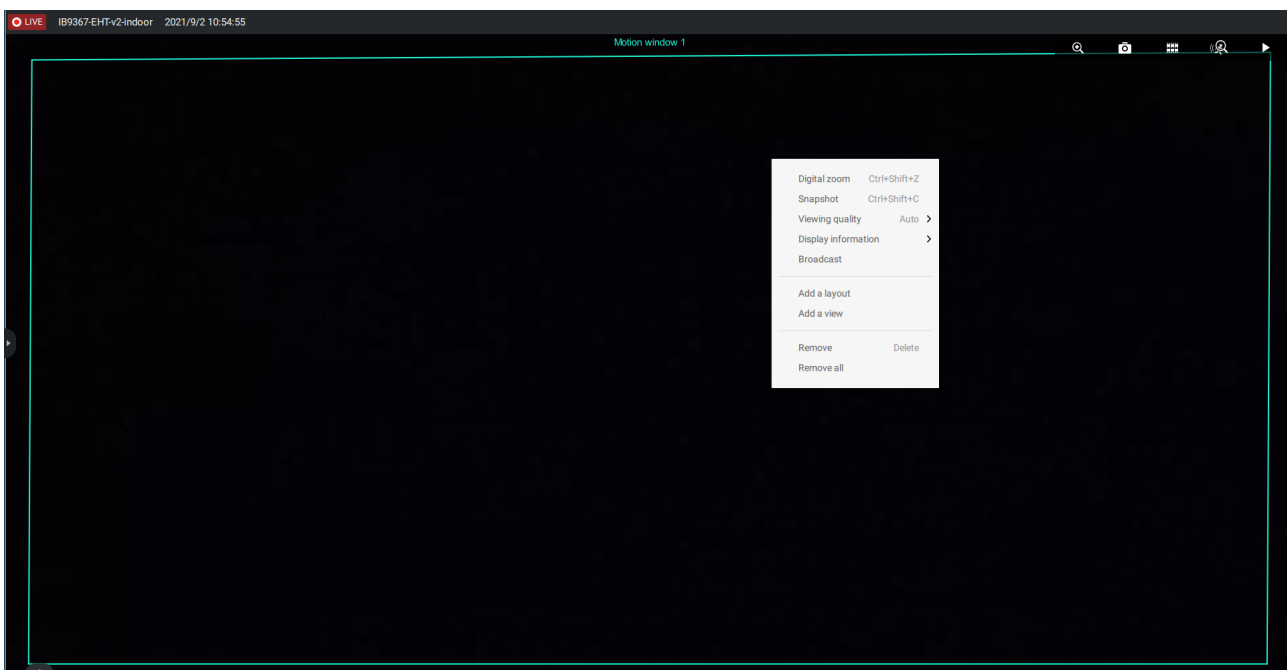

You can create groups for different audio devices. Use the Group tab to create audio groups. Select devices for the group.

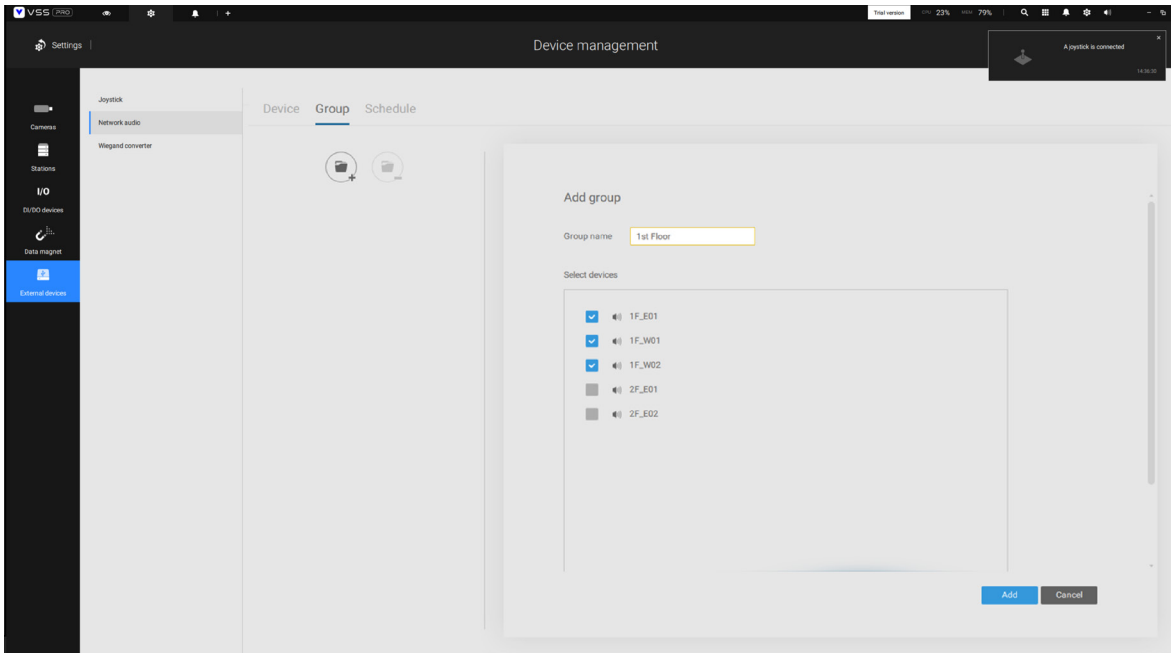

With audio groups, you can select audio devices from the Devices tab on a live view so that you can broadcast audios to a group of devices.

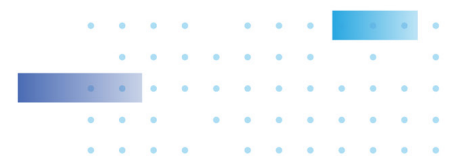
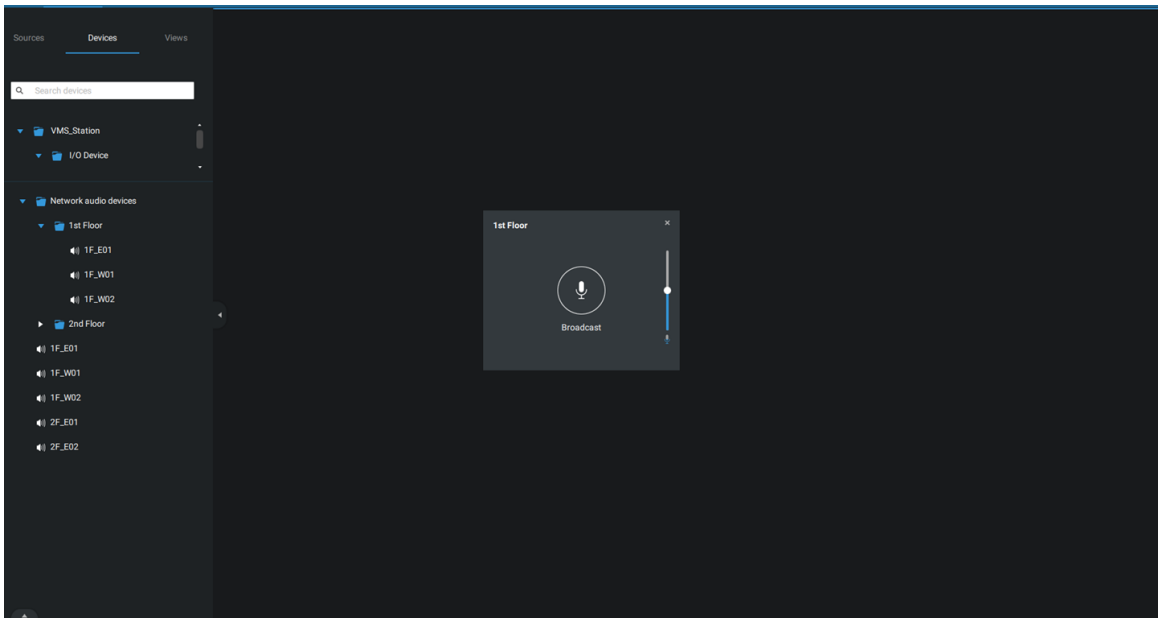

You can create a schedule to play a pre-selected audio file. In Network audio > schedule, create a schedule. Select a start time. Select an audio file for broadcast. Select a repeating pattern by hour, by day, or by the week days. You can also specify an audio group to play by the schedule.

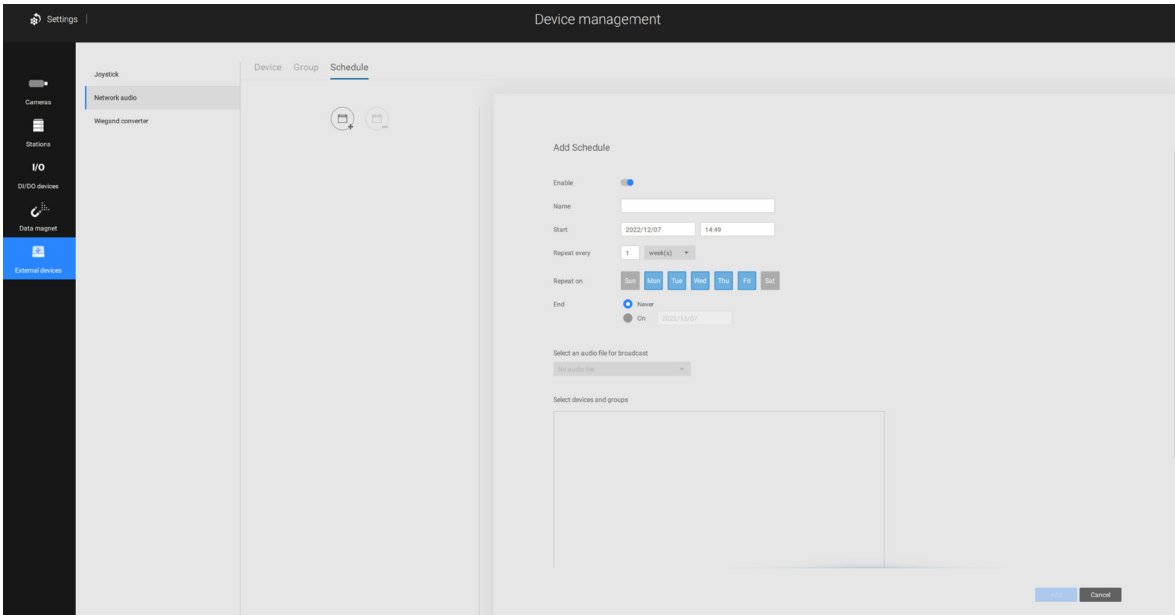

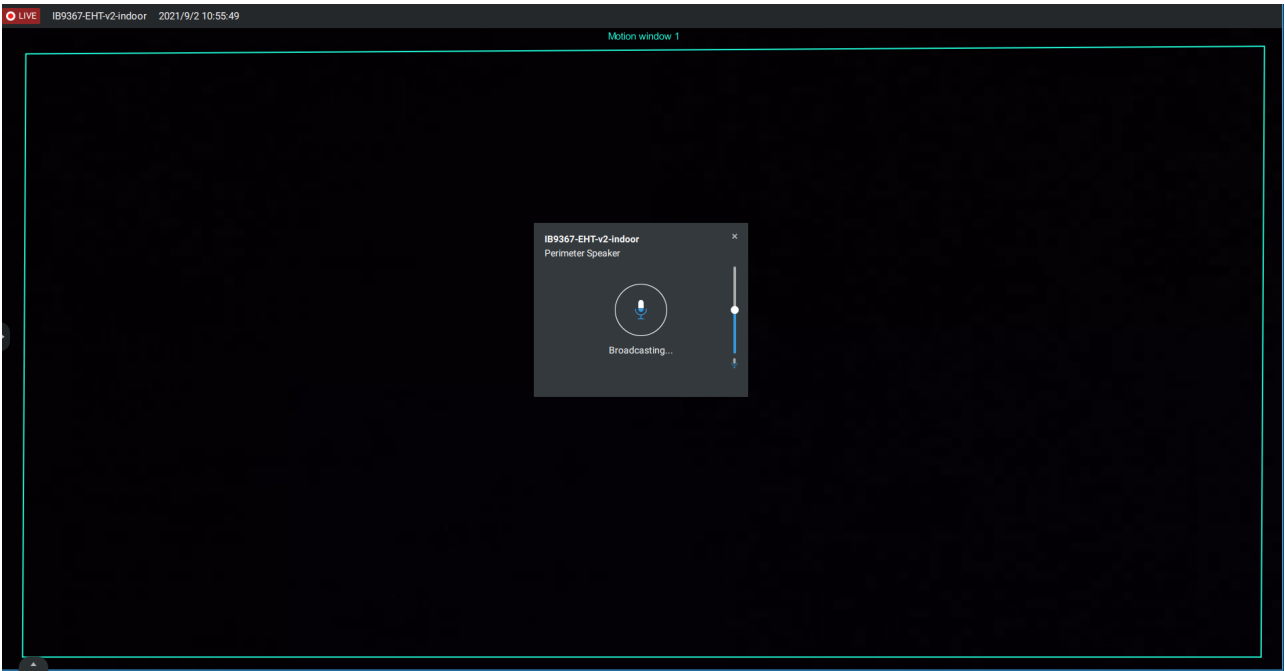

Appendix E: Upload Device Pack

A device pack is constantly updated for the latest profiles of VIVOTEK's new camera/NVR models. If you install new cameras/NVRs to your configuration, you can visit VIVOTEK's website for the latest device pack updates, and upload the pack file to your VSS server. New functional parameters and functions in the new cameras are available through the device pack.

Enter Settings > About to see the upload button.

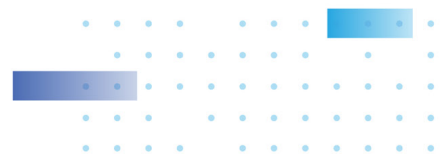
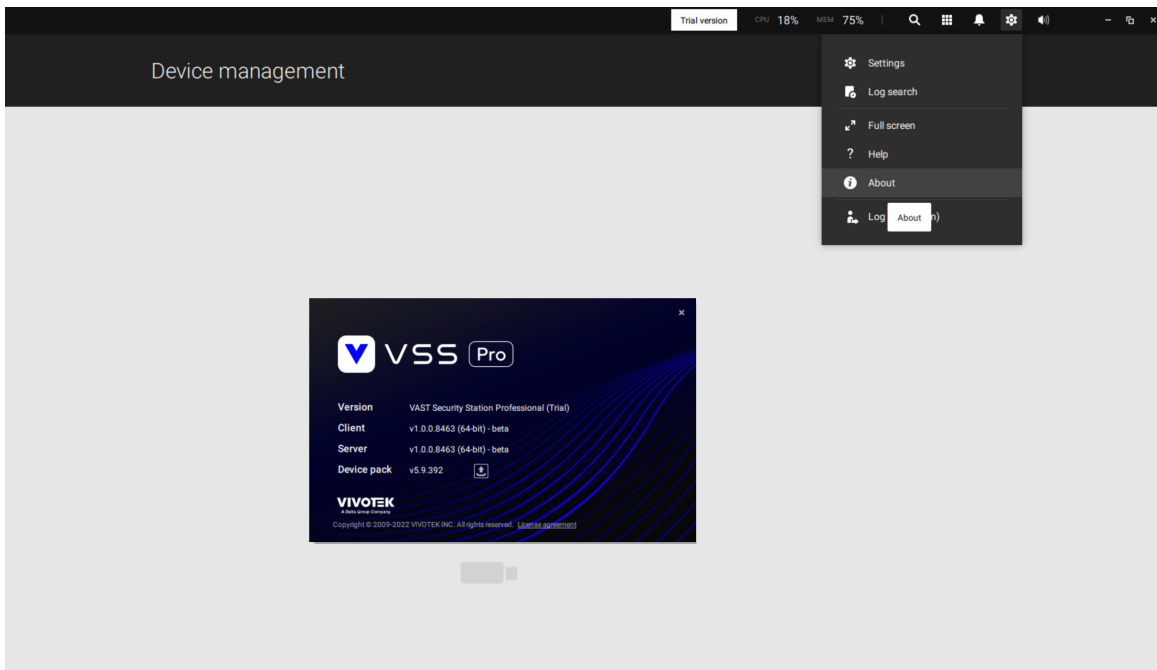

A device pack file looks like the following.

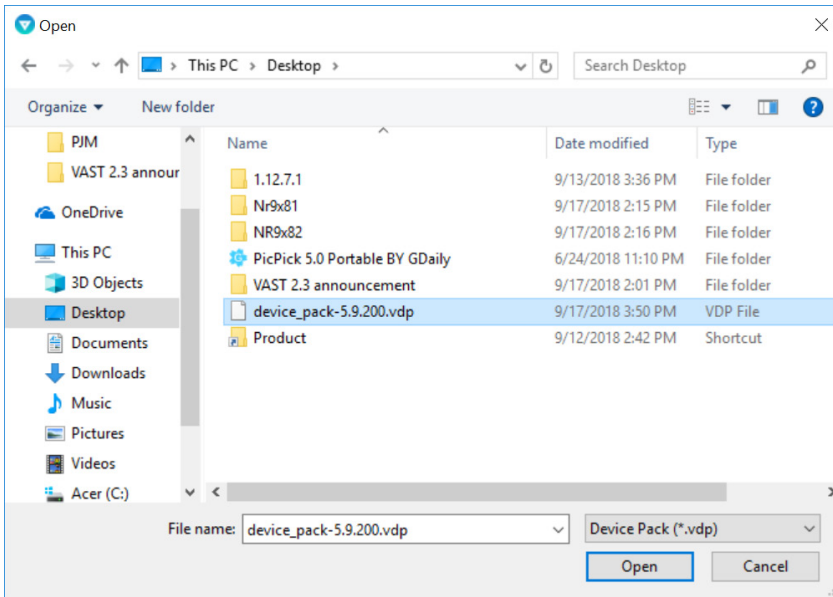

Appendix F: Using LPR Related Functions w/ Data

Magnet

Acquiring data sources from 3rd-party software:

1. Select a camera that comes with the LPR (License Plate Recognition) functionality, e.g., IB9387-LPR as shown below. Click "More settings on Web" to open a web console to the camera.

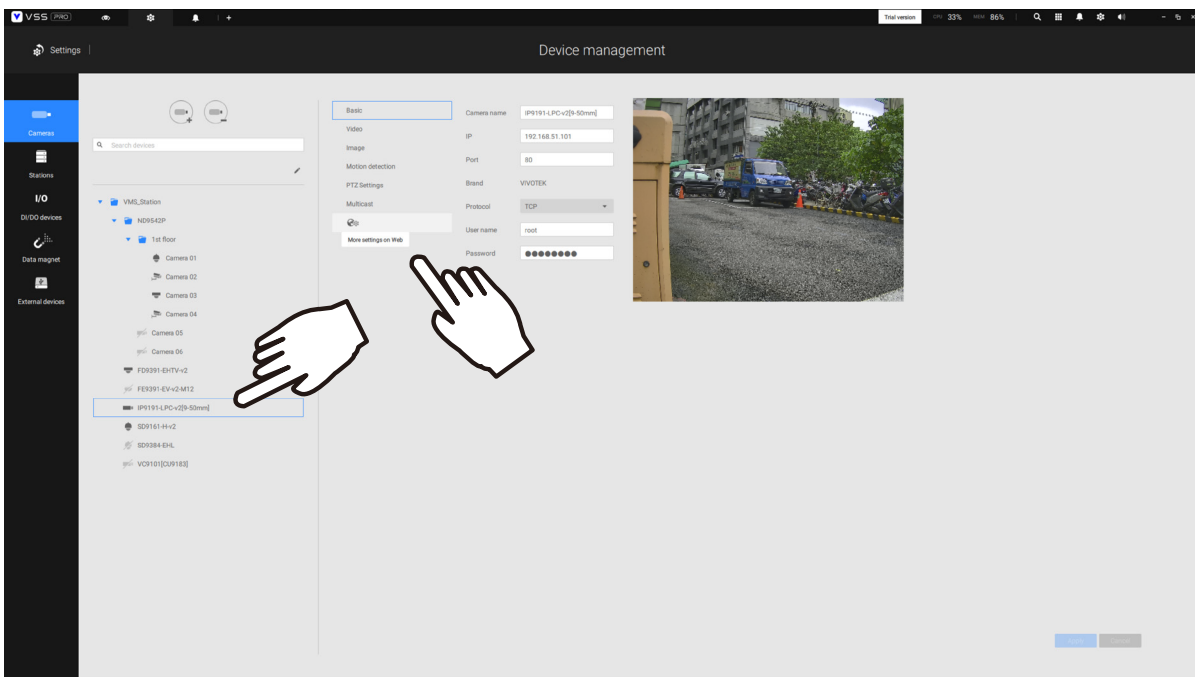

2. On the web console, enter Configuration > Applications > Package management. Click on ANPR to open a web console to the license plate recognition software.

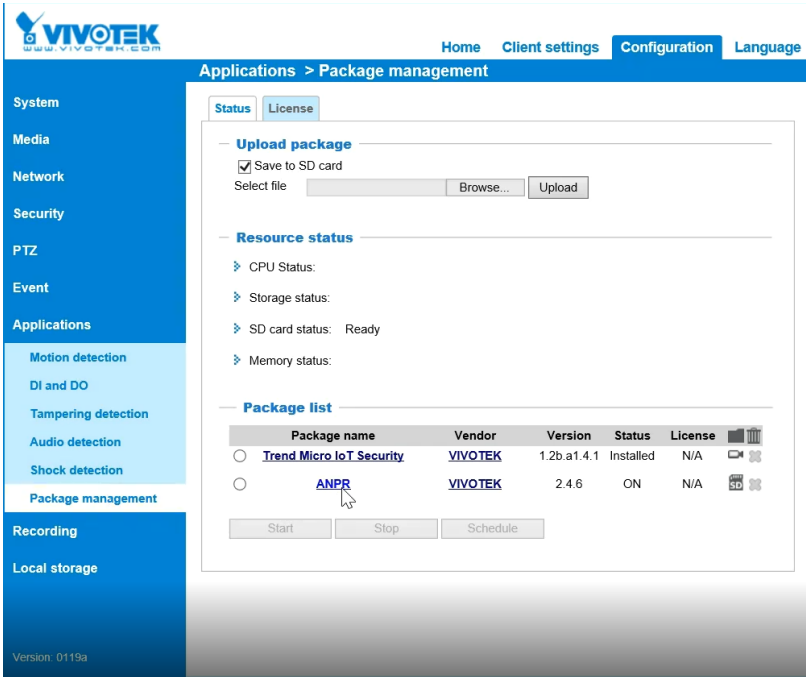

3. Click on the Lists tab.

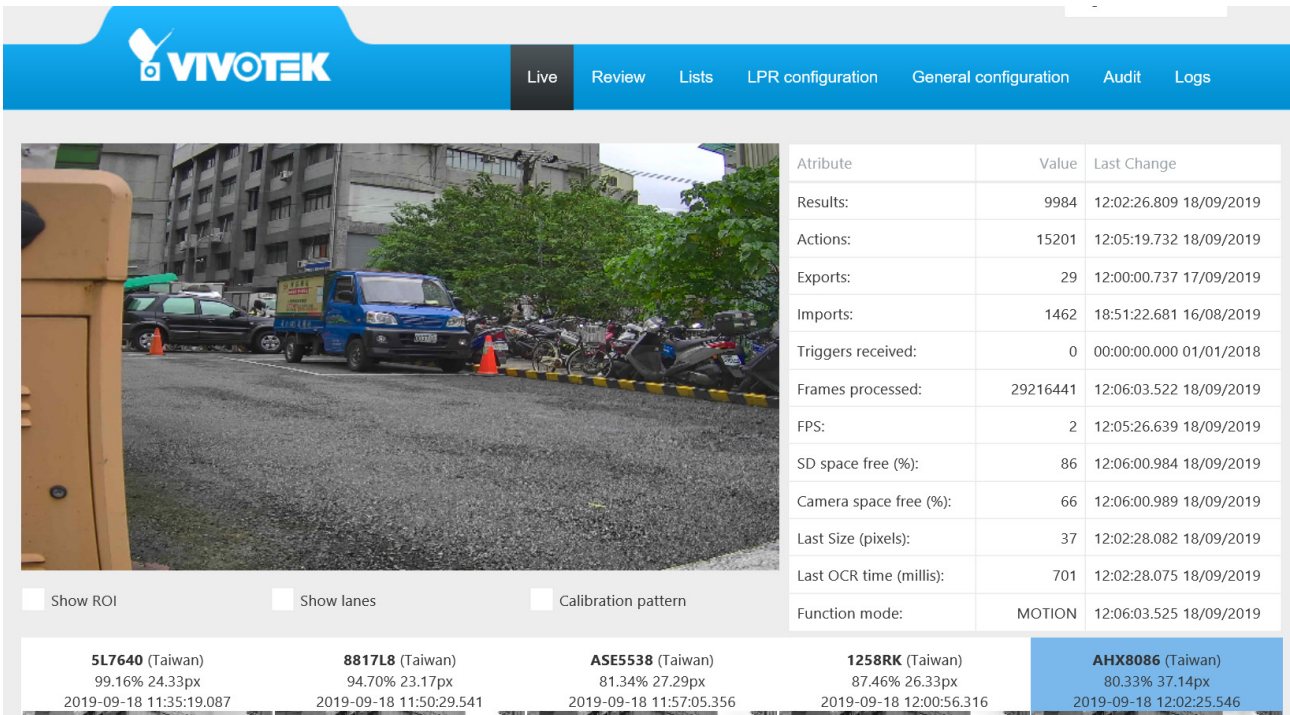

4. Select a list whose data will be transmitted to the VSS server.

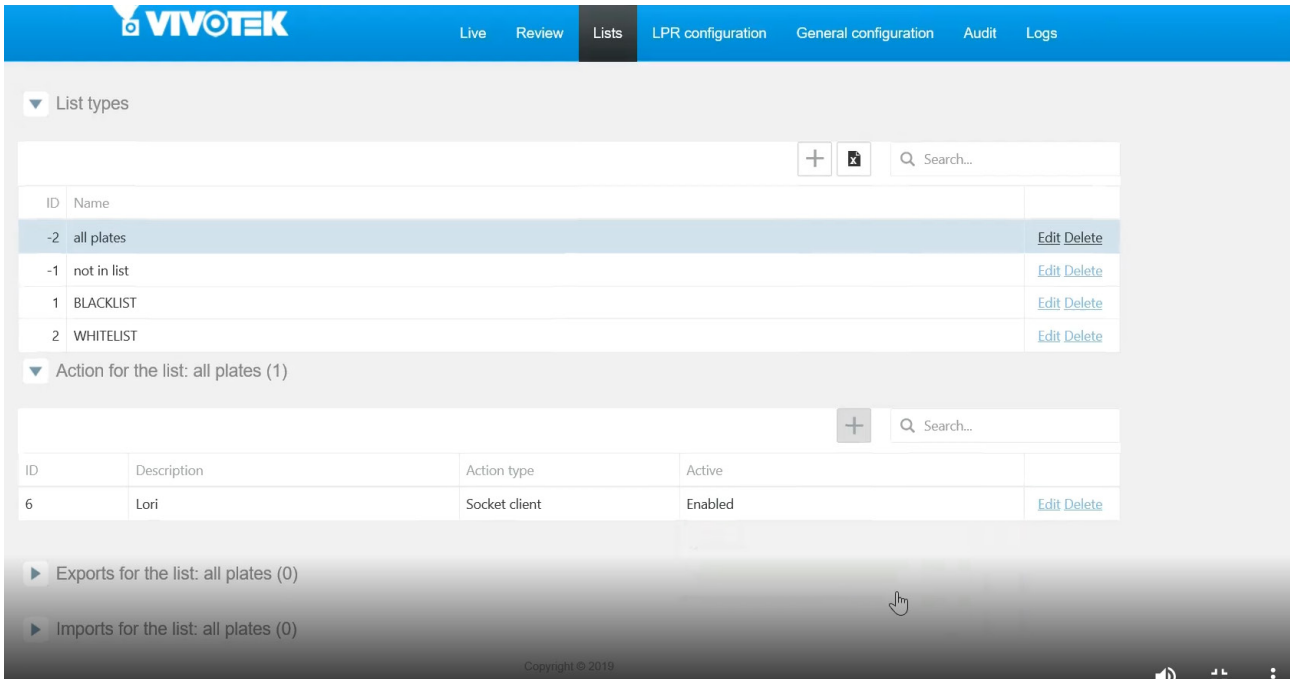

5. 5-1. Find the "Action for the list" pane. Click the "+" **Add a row** button.

5-2. Enter a short description for the row.

5-3. Select "Socket client" as the action type.

5-4. Click to select Enabled.

5-5. Click the Save button.

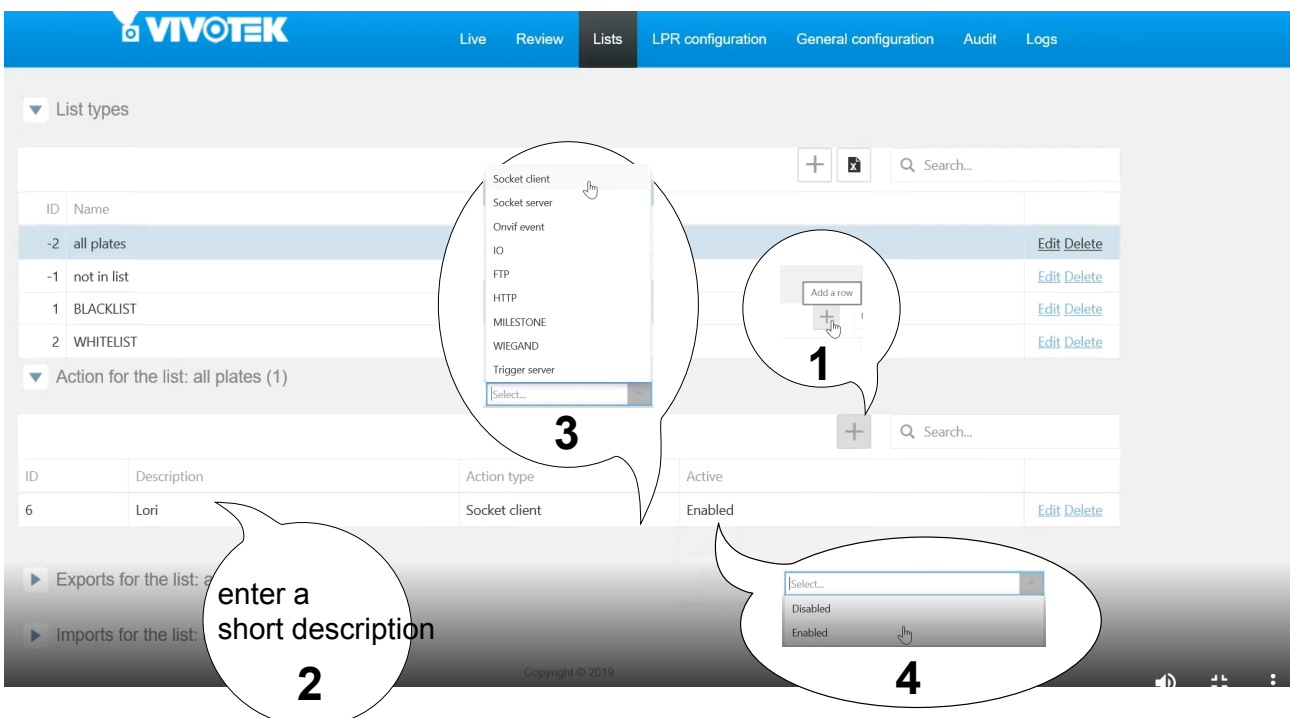

6. Roll down to enter your VSS server's IP address. If necessary, select XML_IMG as the file format for your data that will be collected on VSS.

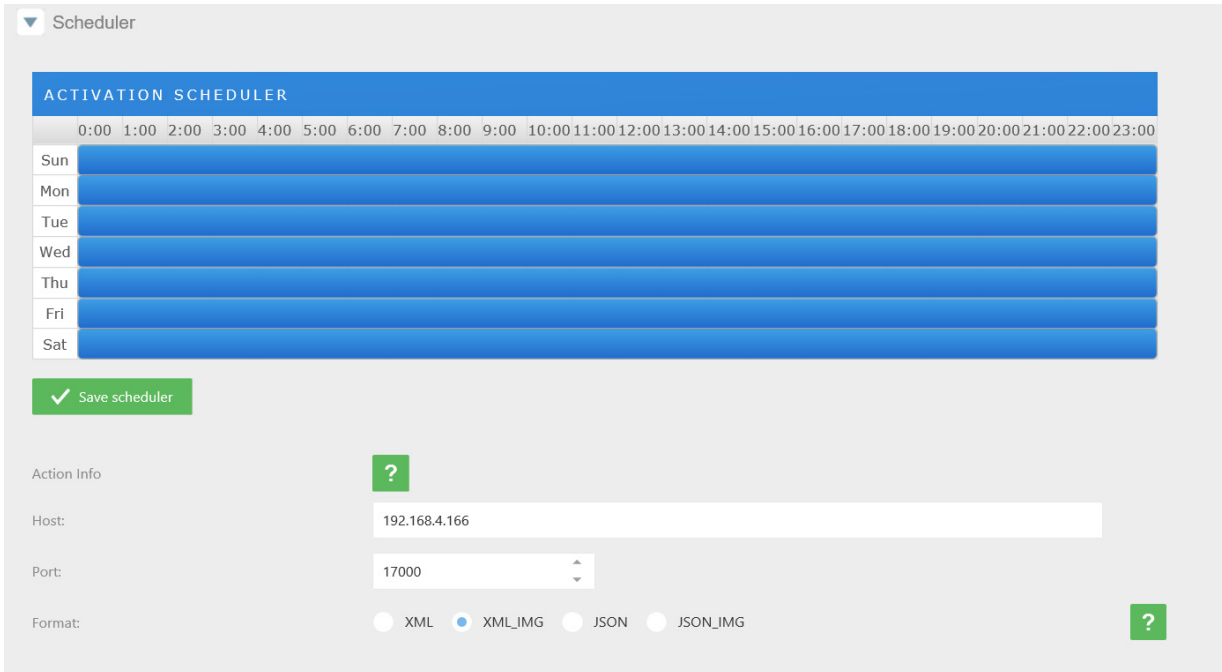

7. Close the web console and return to the VSS Settings > Device management > Data magnet page.

Click the Add button, and click the License Plate Recognition button.

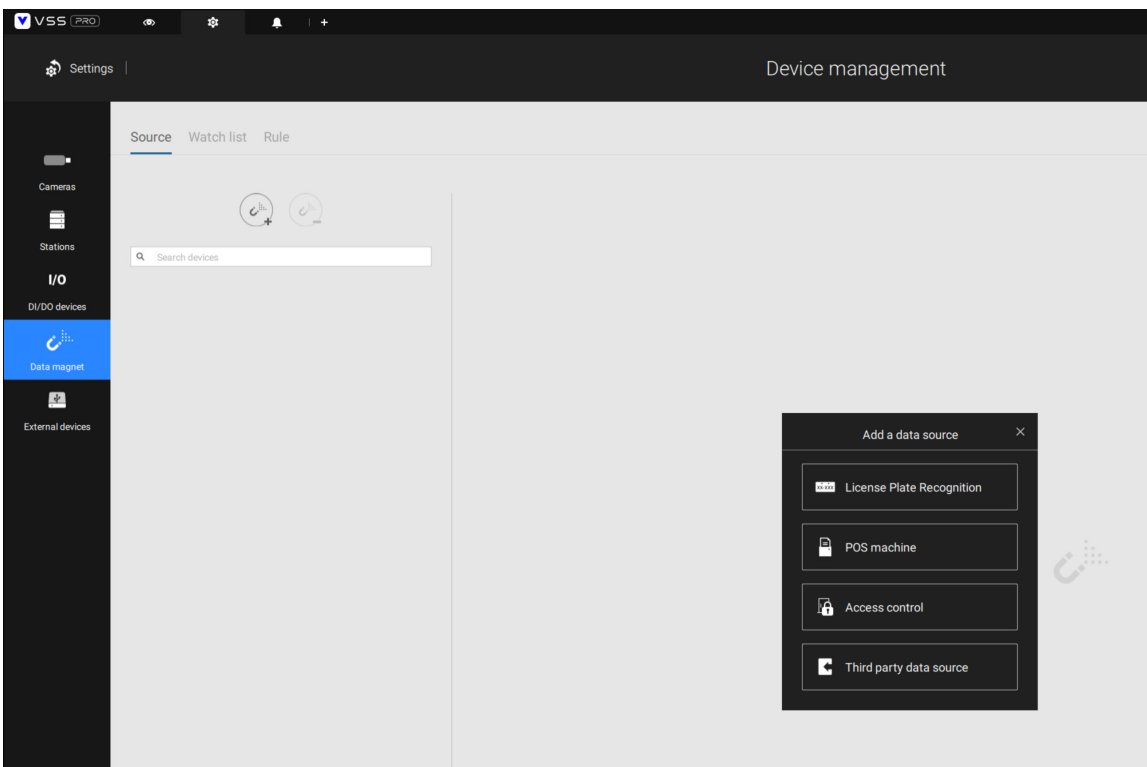

NOTE:

1. The VSS server port for License Plate Recognition data source can be customized; It is not limited to 17000.
2. If you have more than one VIVOTEK LPR camera, you only need to (and can only) add a License Plate Recognition data source.
3. If you add a 3rd-party data source but you name it as "VIVOTEK ANPR", it will be recognized as a VIVOTEK ANPR (License Plate Recognition) data source.
4. Different Data sources cannot have the same name.
5. Different 3rd-party data sources can share the same server port, but they cannot use the same port the License Plate Recognition is using.

If you need the development document for integrating 3rd-party software, please contact VIVOTEK's technical support.

You can designate how many days the data from the data sources is retained on server in Settings > System management > Preferences.

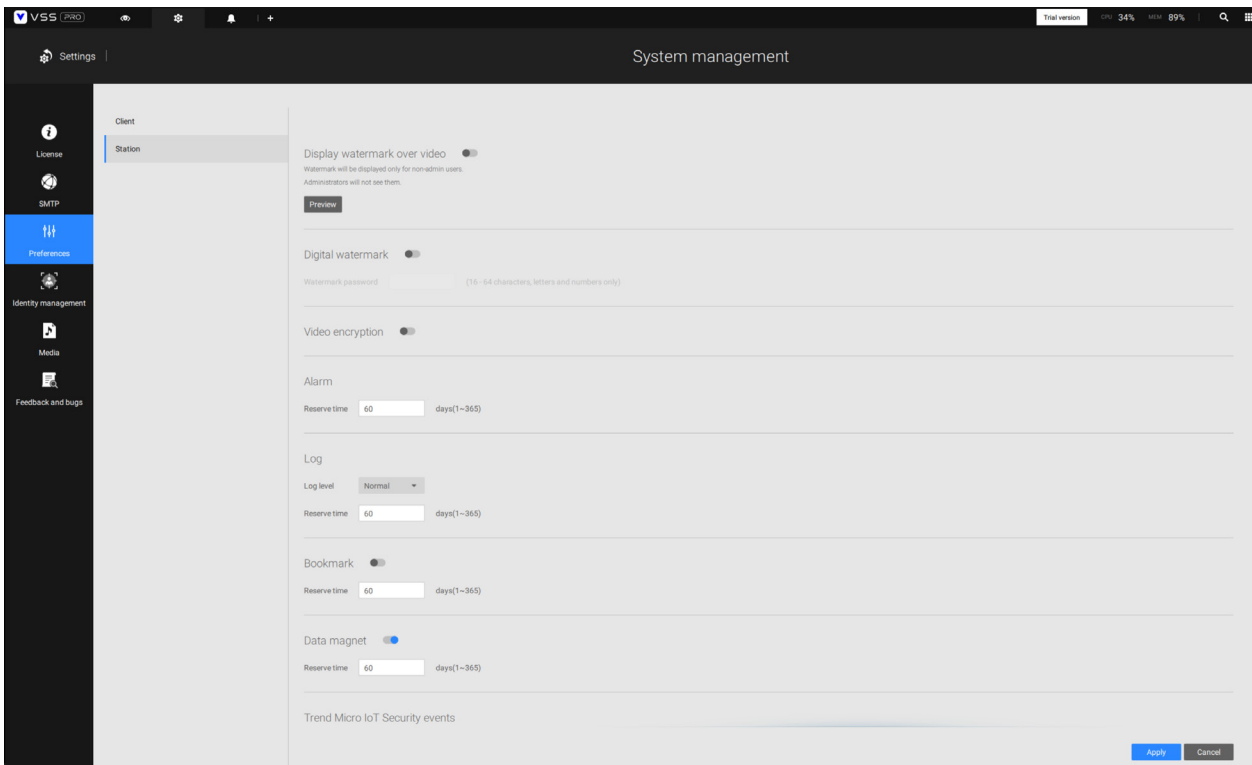

Configuring a Black or White list:

With a license plate application, you can configure either a Black list for suspicious plate numbers, such as those for unwelcome or stolen cars, or a White list for VIP customers or the employees of your facility.

1. Click and select Watch list in the Data Magnet window. Click the Add button, and enter a name, e.g., Stolen car. Select "VIVOTEK ANPR" and camera as a data source, and enter a classification for the referential parameter in your Data Magnet json, e.g., PlateNumber.

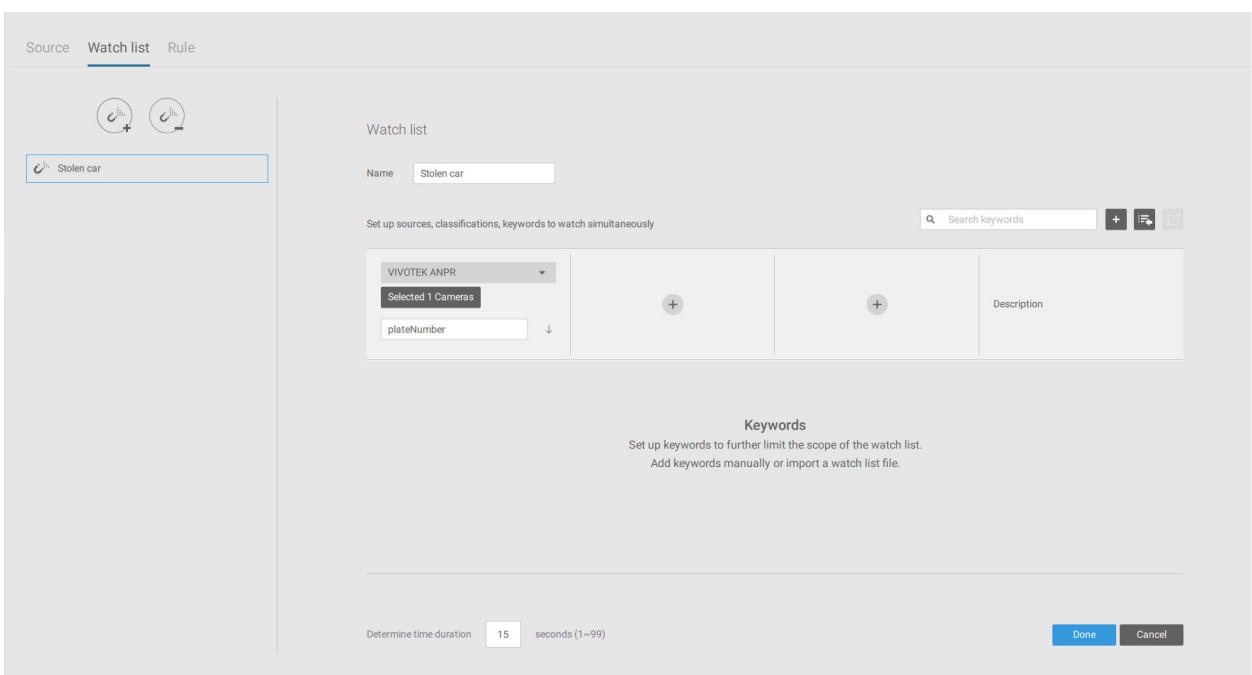
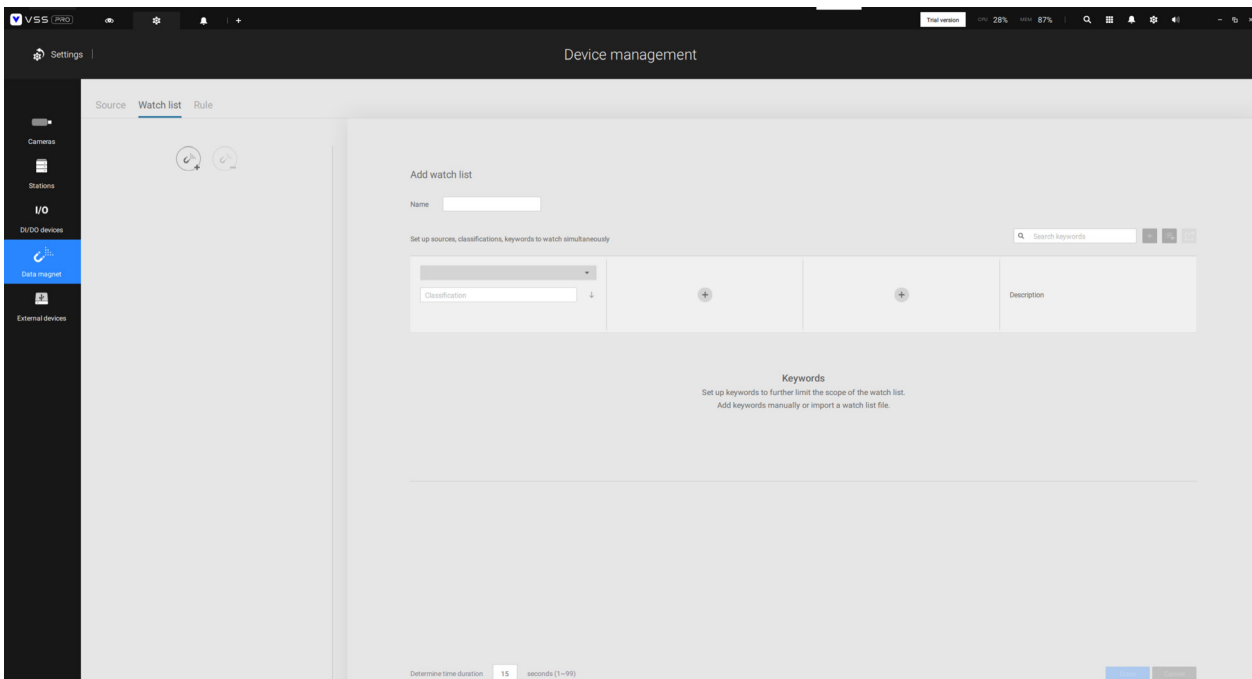

2. Click the Add  button and enter a plate number such as one for a stolen car. Click Add to finish, and repeat the process for more items.

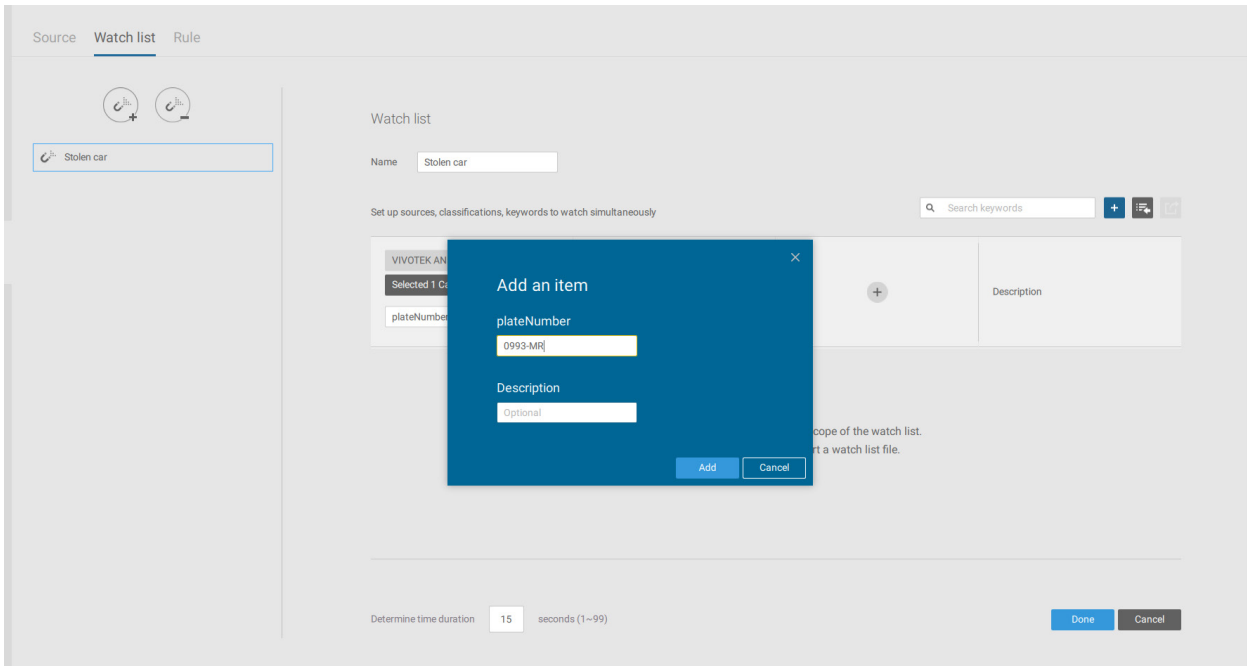

3. The added items will be listed. When done, click the Done button below.

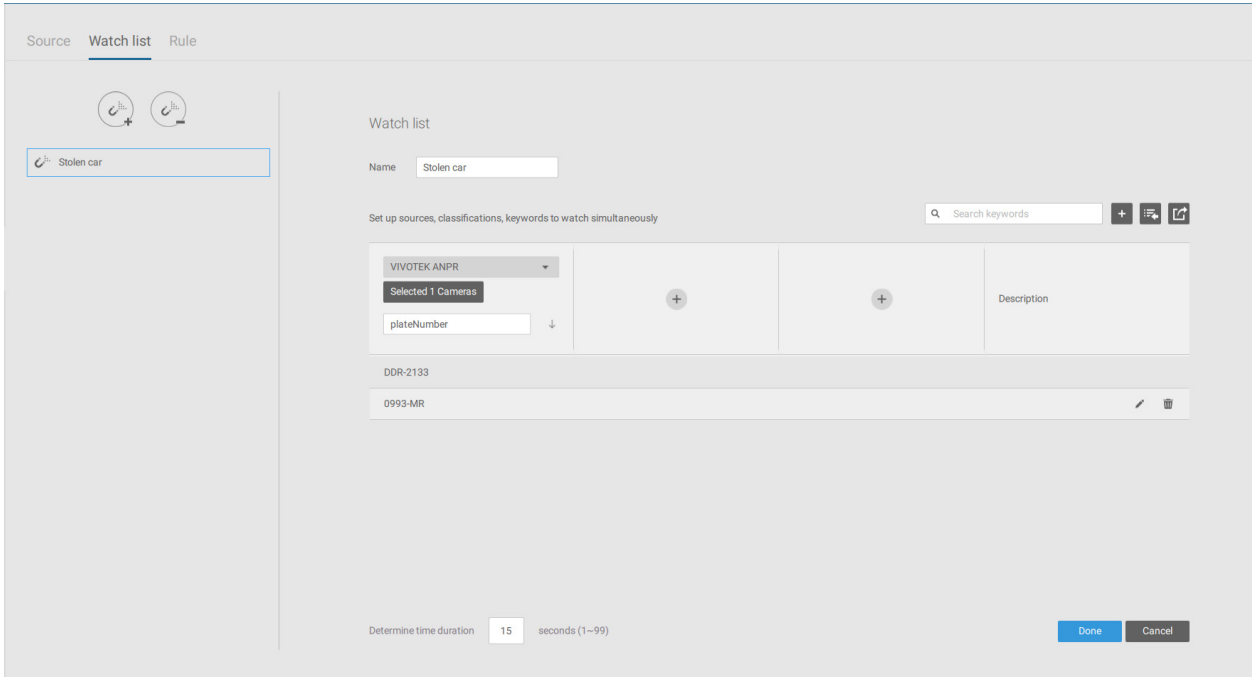

4. Using the same method, you can create a White list for some plate numbers to gain access, such as VIP customers.

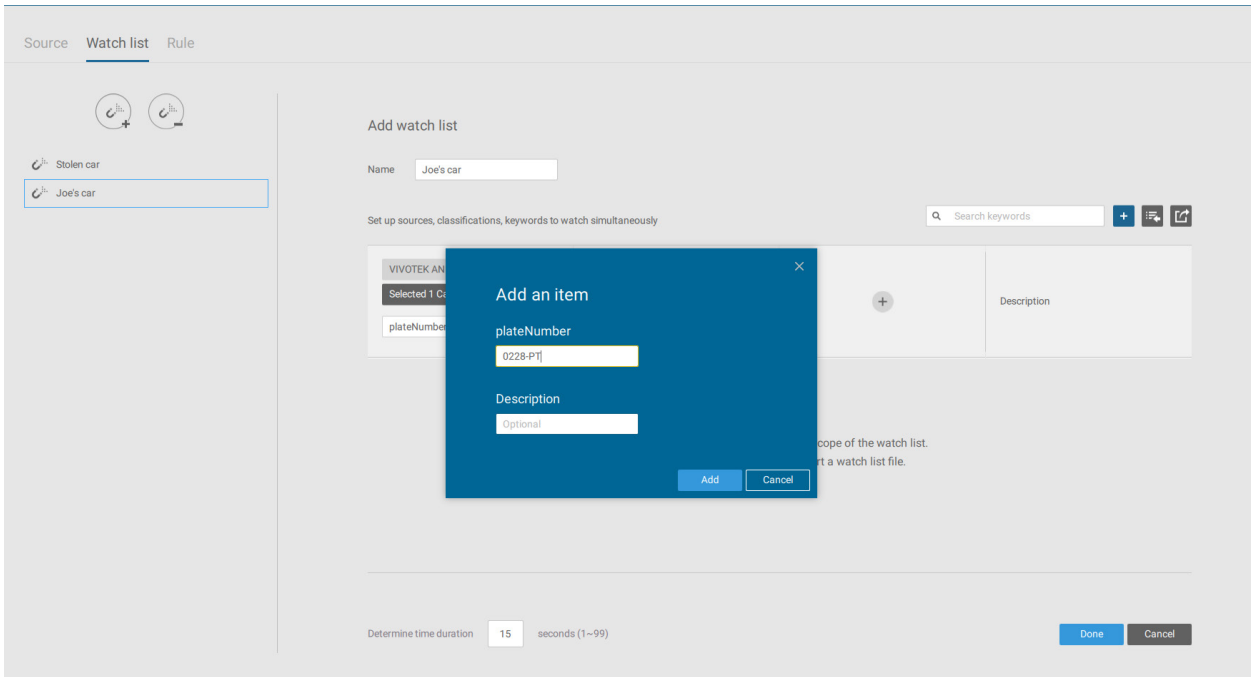

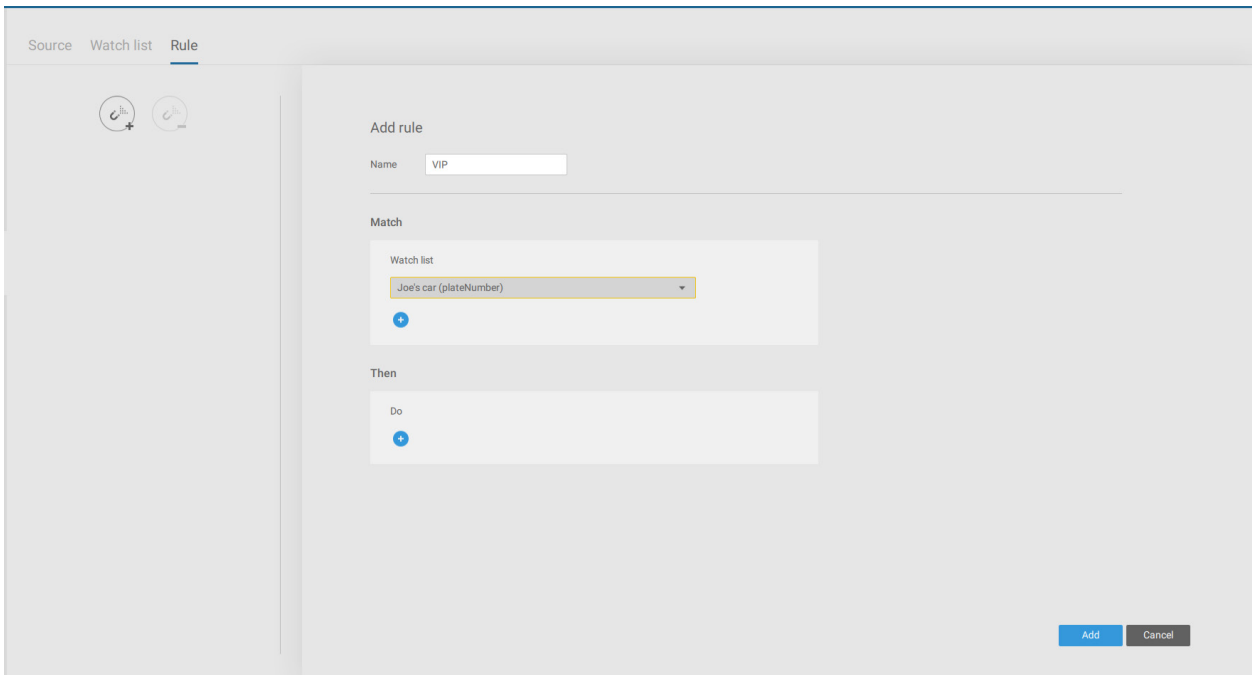

5. Click on the Rule tab. Click the Add rule button then enter a name for the rule. Select a Watch list you previously configured.

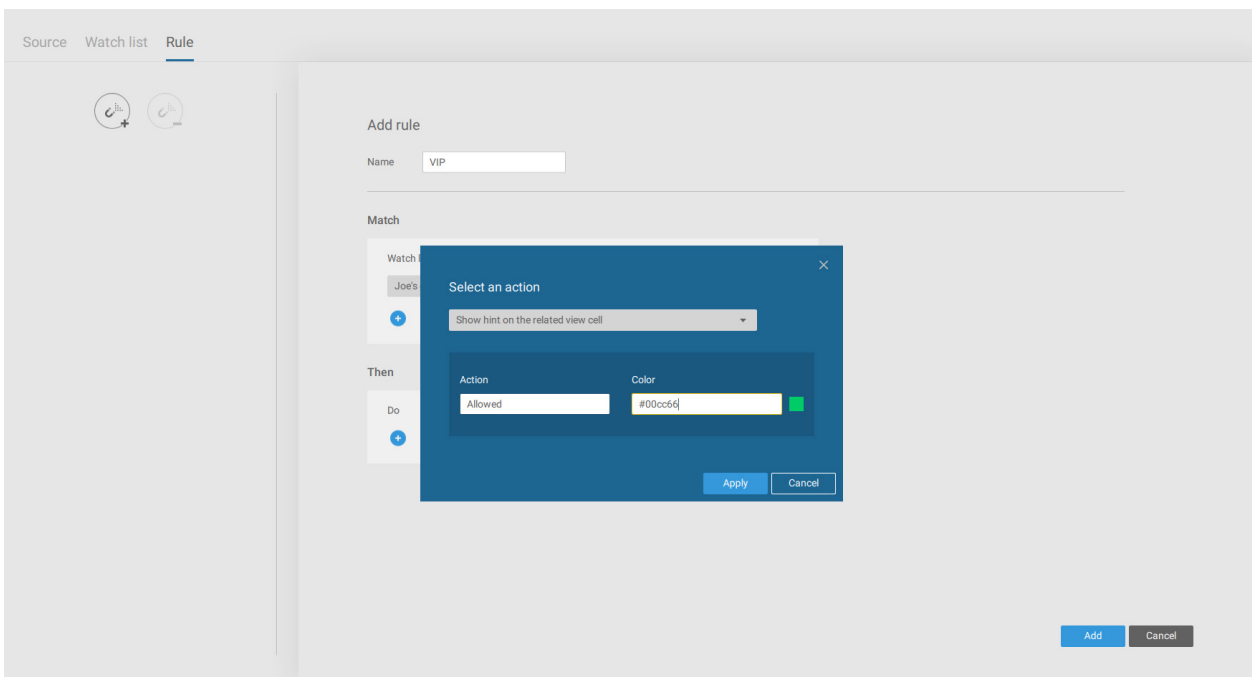

6. Select an action such as Show hint on the related view cell. Enter a word you want to show on the related view cell. Enter hex color code for the word displayed on view cell. Click Add to finish the configuration.



Source Watch list **Rule**

Add rule

Name

Match

Watch list

Then

Do

Show hint on the related view cell

Action
Allowed

Color
#00cc66



7. On the VSS view cell, the ALLOWED or DENIED rule message will display along with your watch list and other information.



Selecting data display options:

1. On the VSS live view, right-click on screen to display Data Magnet > Edit display data.
If Show data is selected, a portion of the view cell will be used to display the captured data.

There are two different ways to show data:

1. Right-click: [Data Magnet](#) > [Show data](#).
2. Right-click: [Display information](#) > [Edit display information](#) > [Data magnet data](#).

The display options are: with or without [Data overlay on screen](#). If the overlay is not enabled, the data will display on the right pane of the view cell.

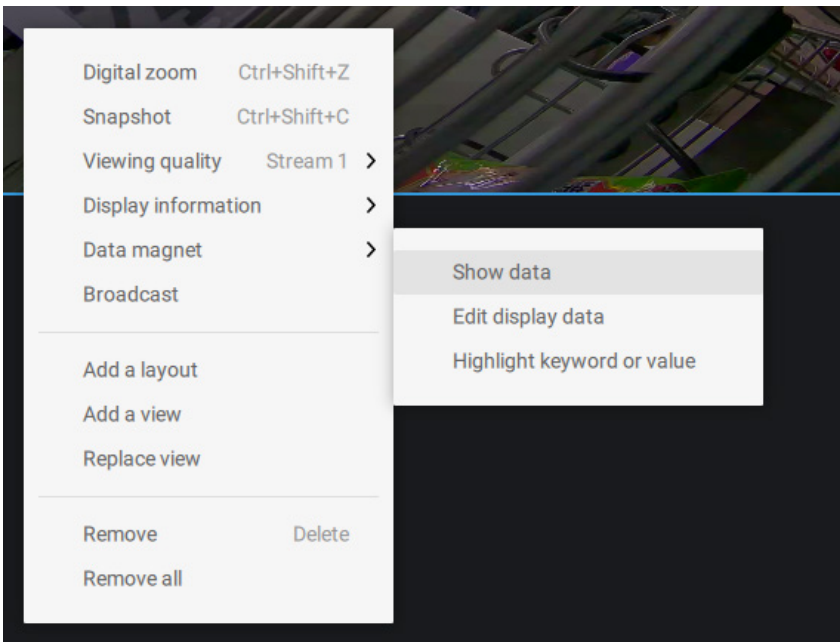

The data on the overlay can be configured to automatically disappear after a configurable time, when no new data is received (Hide data after idle _s).

2. On the Edit pane, select all or manually select multiple display elements.

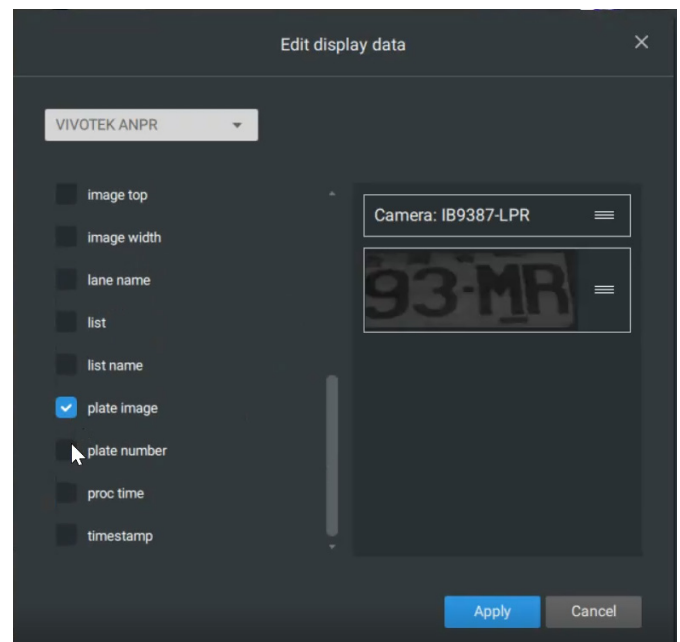
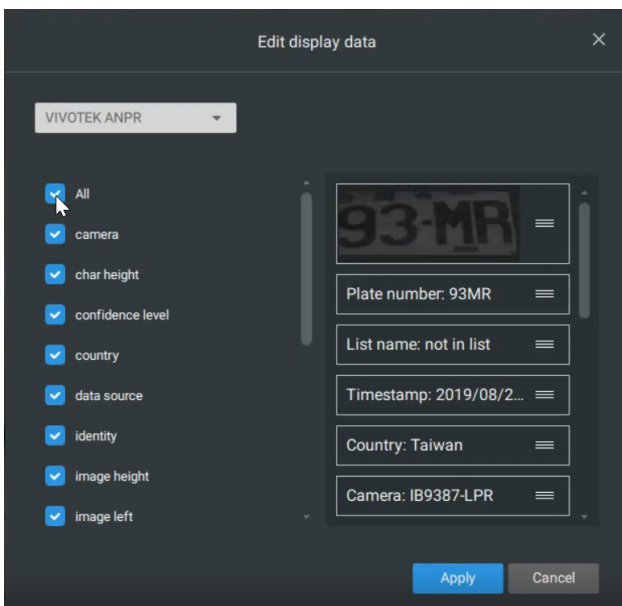

3. Click and drag individual elements to change their top-down positions on the screen. When done, click the Apply button.

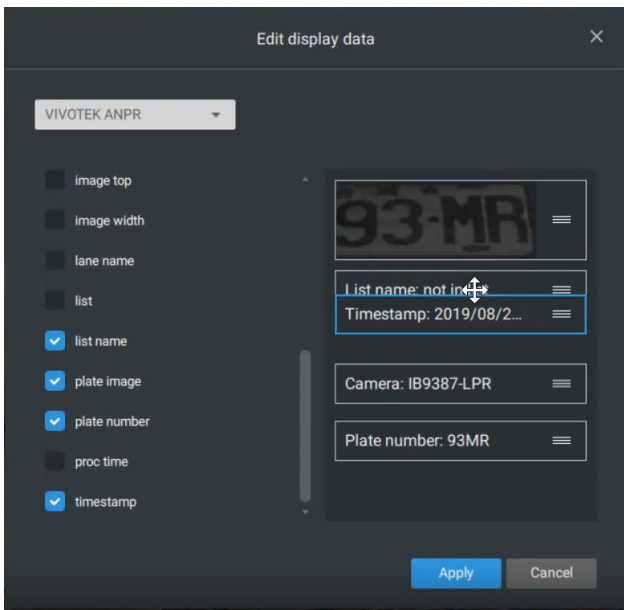

4. Click Highlight keyword or value. You can display information of unusual data, such as the specific numbers or characters of forbidden license plates. When such data is met, the occurrence will be highlighted in a bright yellow color.

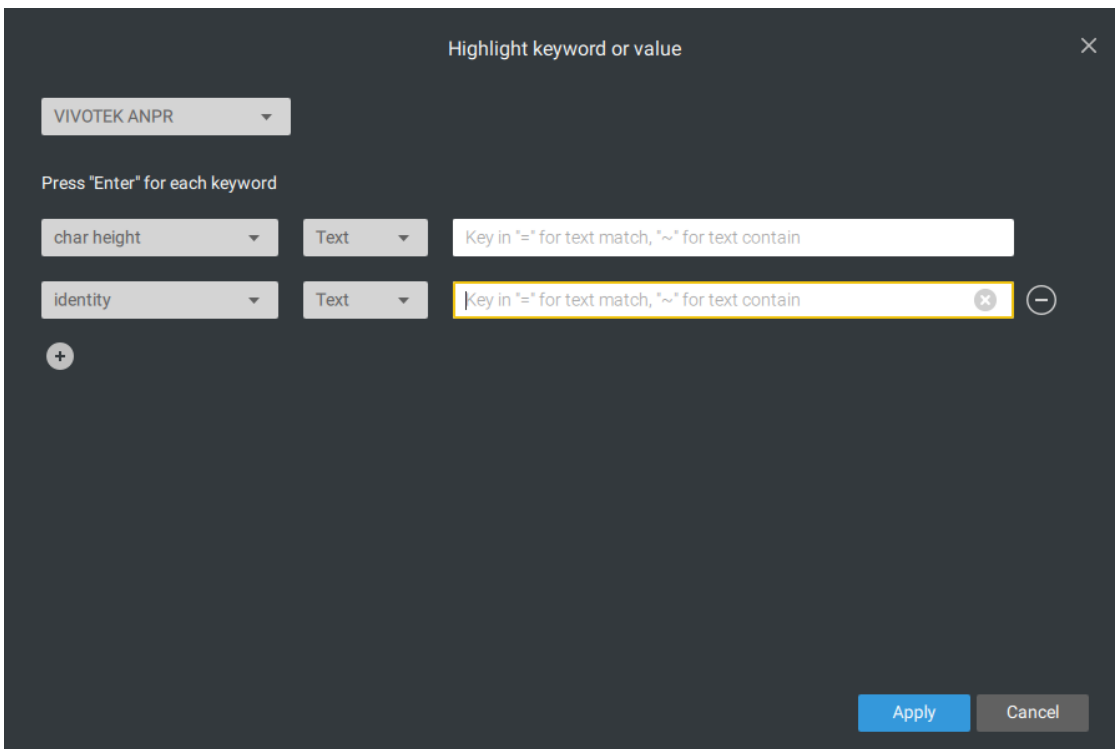

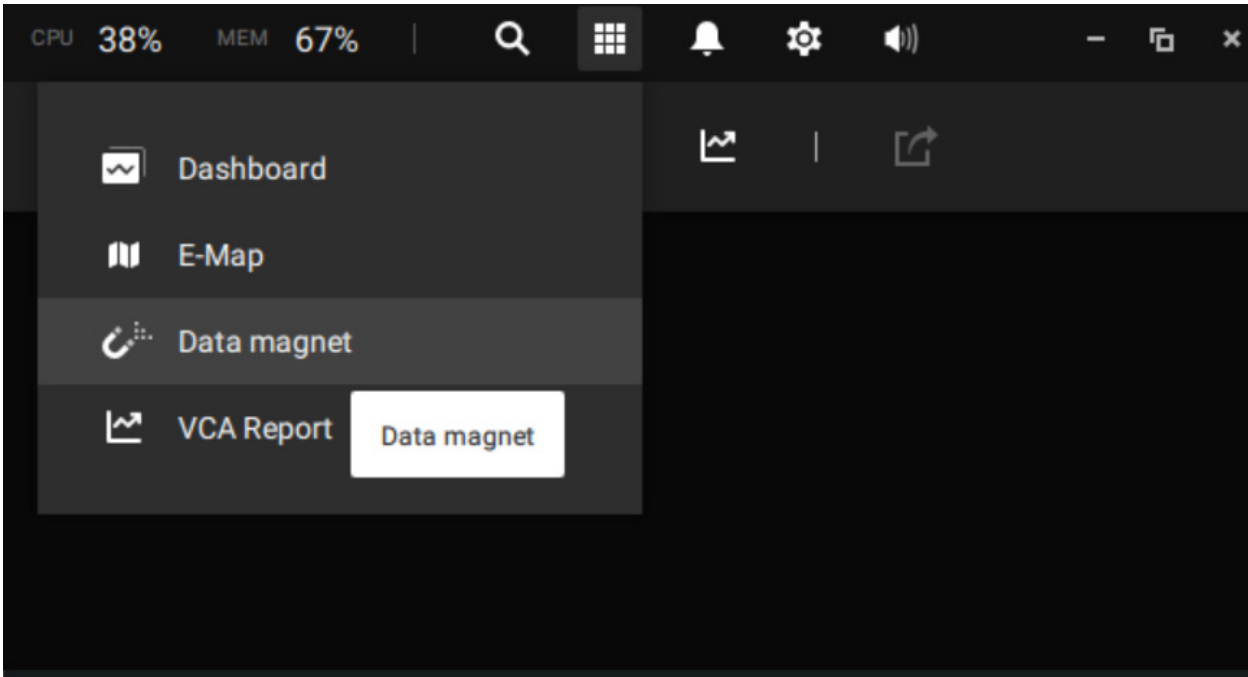

Searching for data and linked recordings:

1. On the VSS live view, click on the Applications tab.



2. On the Data Magnet window, select the LPR camera, and then begin with configuring the search conditions. Select the time span from the calendar. Select to display character height, country, data source, identity, image height, lane name, list name, or enter a plate number. You can select multiple filtering conditions.
3. Click the Search button. The search results will display. Single-click to display the related video. You can also review the video in a full-screen mode.

You can click and drag the display names of individual columns to switch their positions on the screen. The changes to layout are stored on the client computer. After you re-arrange the order of columns in search results, the display order will also be applied to the exported CSV file.

4. You can select and export a license plate capture using the Export function. Click on the  export button. A folder button  will display. Click on it to access the exported file.

The target directory will open. Open the exported CSV file to view the search results.

You can also open a chart view by clicking the  Chart view button. The chart view can also be exported as a png file.

An evidence image will be available with the search result along with the plate picture.



Configuring Data Magnet alarms:

1. Enter Settings > Alarm > Add & Delete to create a new alarm setting. Click to select  External devices.
2. Select VIVOTEK ANPR as your triggering source. Select and create triggering conditions such as character height, image width, list, list name, country, etc. Use "=" for text matching, "~" for text containing, or approximately matching specific characters, and also ">," "<," ">=," "<=" for numbers larger or smaller than a preset value.
3. Continue to configure your triggering conditions. You can create multiple conditions.
4. Continue to configure the actions for a triggered alarm, such as sending live streaming.
5. When done, enter a name for the alarm and click the Add button to complete.
6. You can now receive alarm notifications triggered by license plate recognition via the Data Magnet.

Note that if you select "Include event-triggering camera" during the alarm configuration stage, the camera delivering the data source will be automatically selected.



Appendix G: Multi-factor Authentication for Access

Control

Via multiple data magnet sources, access authentication can be achieved for the following:

1. License plate recognition system, Face recognition system, 3. Access control system.

For example, in a parking lot, if someone wants to leave, the LPR system at the gate will recognize the license plate, and the face recognition will verify the driver's identity. If both recognition succeed, the gate will open allowing the driver to leave.

In an office, an access control system can be combined with Face recognition mechanism to avoid someone using someone else' card to cheat the attendance system.

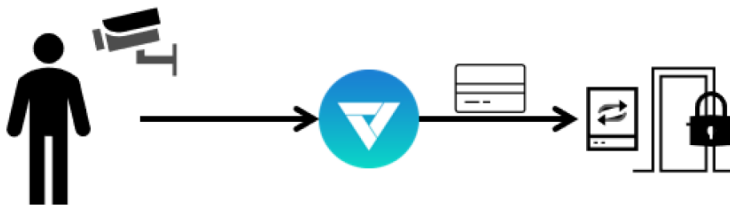

The scenario shows one holds an ID card and via the Face recognition system, his identity is verified as one employee in the database. VSS then acquires his ID card serial no., passes it on to an Wiegand converter. The Wiegand converter then passes it to the access control. In addition to the original ID card access control, multiple utilities can be combined into the access control mechanism.



To acquire data from multi-factor systems, we use the Watch list on Data Magnet.

1. Depending on your applications, configure multiple data magnet sources, so that data can be transferred and acquired by VSS.
2. Click and select Watch list in the Data Magnet window. Click the Add watch list button, and enter a name, e.g., Employee list. Select 2 or 3 pre-configured data sources, and enter the classification you would like to watch for the referential parameter in your Data Magnet json, e.g., name, ID.

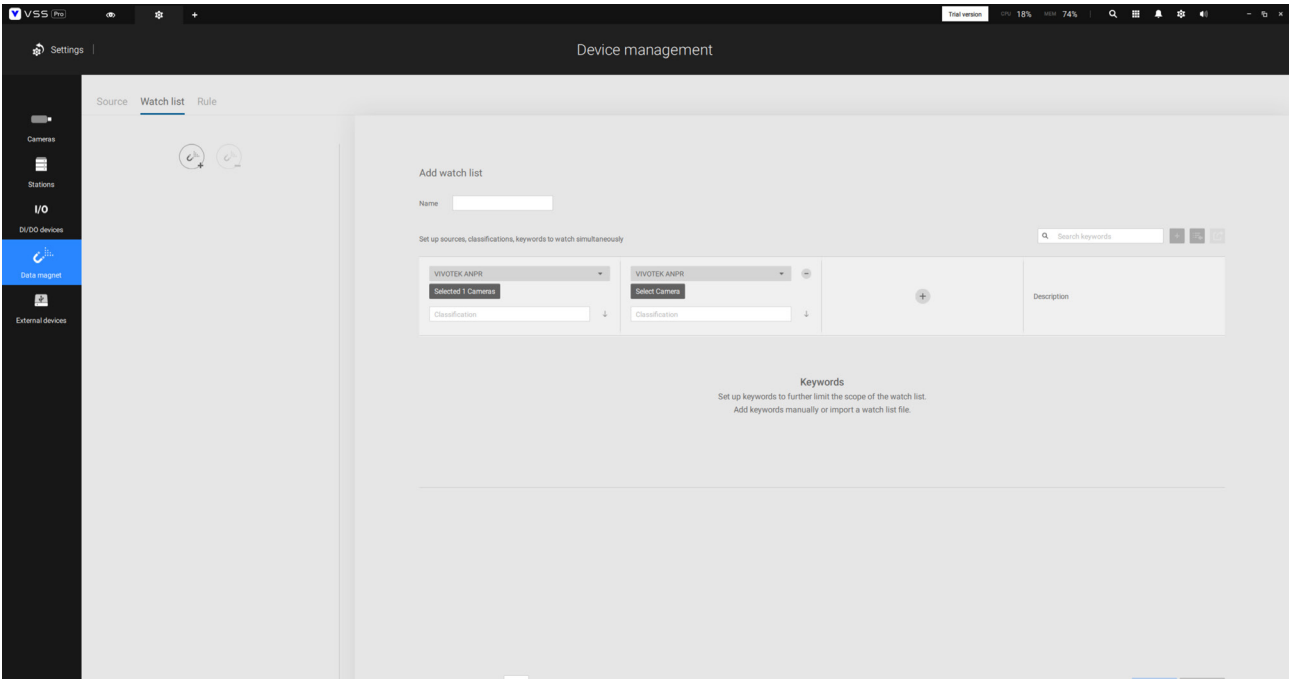

3. Click the Add item button and enter a name and employee ID such as one for an employee. Click Add to finish, and repeat the process for more items.

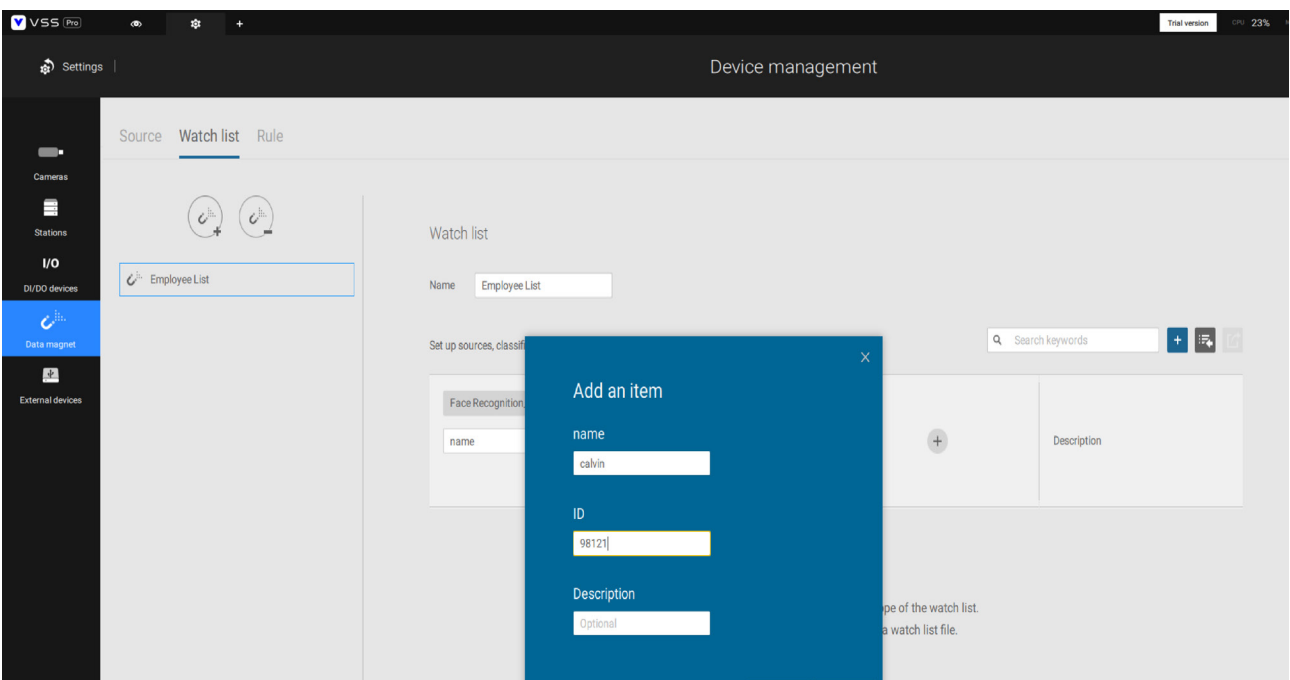

4. At the lower screen, enter the time threshold for receiving data from multiple sources. For example, If set to 15 seconds, VSS will need to receive within this time the facial recognition and the card ID no. from the access control reader. Both data will be verified and checked against the data on the watch list, e.g., name=Chris, ID=90223.

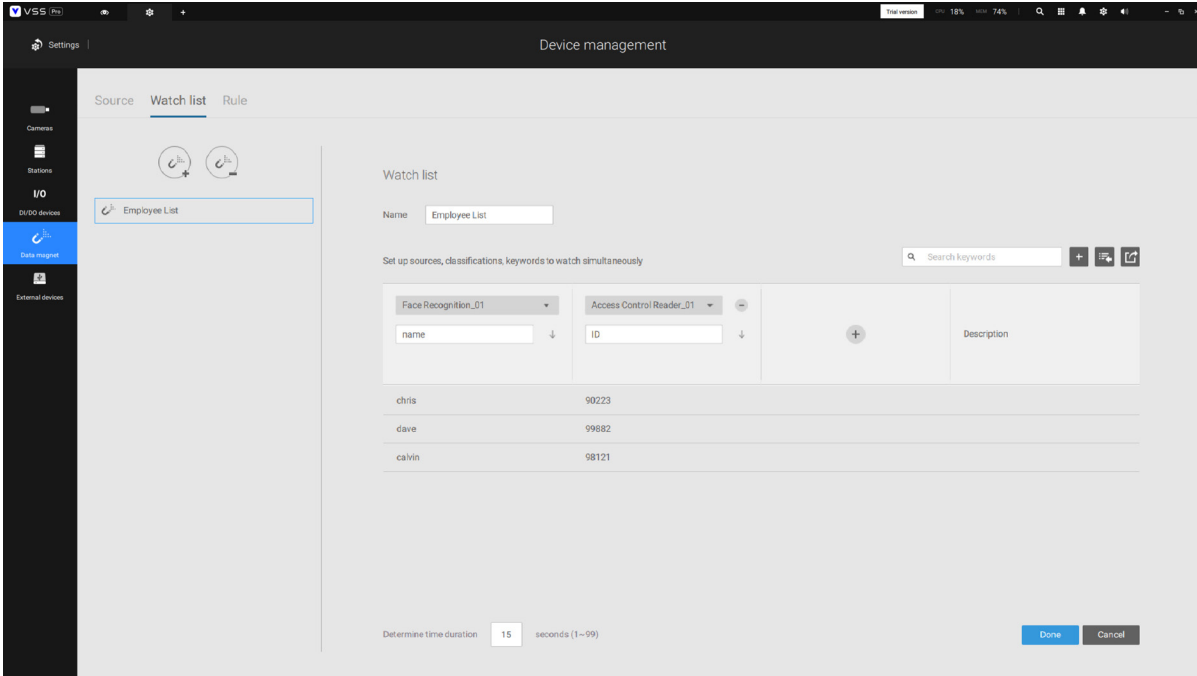

5. Click on the Rule tab. Click the Add rule button, and then enter a name for the rule. In the Match block, select a Watch list you previously configured. In the Then field, you can configure your rule action. There are 2 actions available:

1. Show hint on the related view cell.
2. Select data to send to Wiegand converter.

If you apply your rule to be an alarm management trigger, you can bypass the Then action settings.

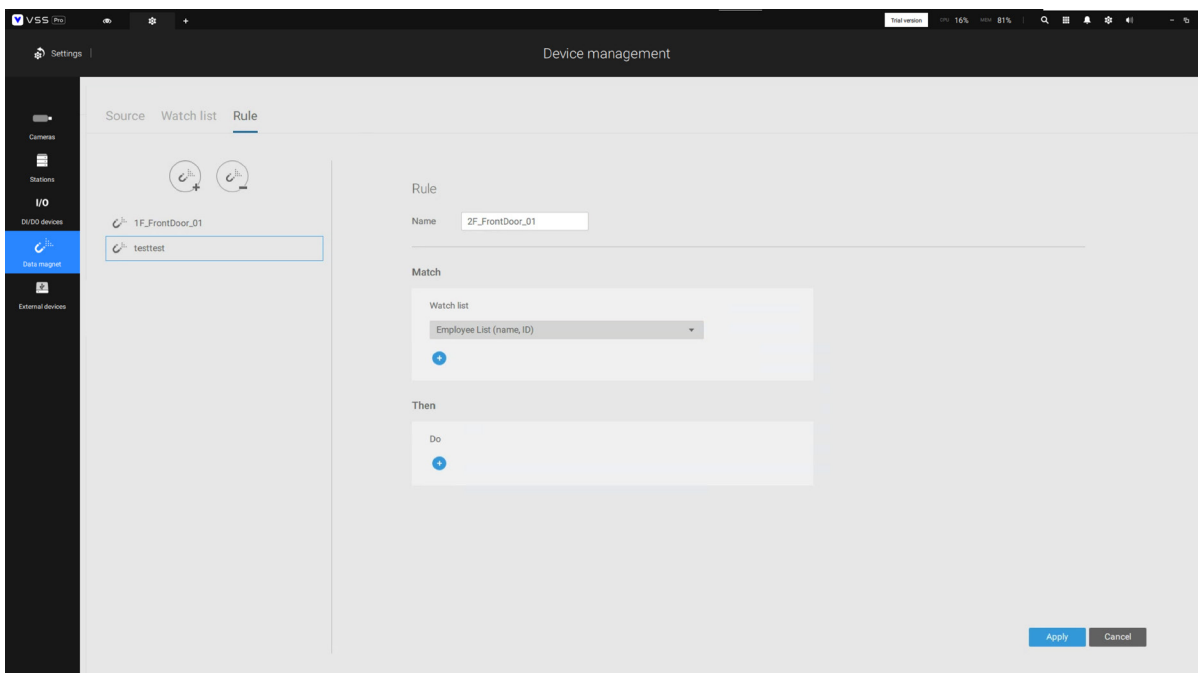

How to configure "Select data to send to Wiegand converter?"

VSS has incorporated the support for Wiegand converter AO-20W (<https://www.vivotek.com/AO-20W>)

The Wiegand converter can transfer the ID Badge card number through the Wiegand protocol to an access control system. The access control system then decides whether to open a gate or not. The VSS station sends an employee's card number to the Wiegand converter, the Wiegand converter then delivers it to an access control system.

To Select data to send to Wiegand converter, first select a watch list classification, and then select a Wiegand converter.

For example, a watch list's employee name=Chris and ID=90223 is verified, you can send the ID card number to the Wiegand converter. If a watch list's data is not the card number, but the data contains name=Chris, employee ID=90223, you can select "Map data to Wiegand card number." Via the Identity management process, the identity data (such as name) is transferred into a corresponding ID Badge Wiegand card number, and then is sent to a Wiegand converter.

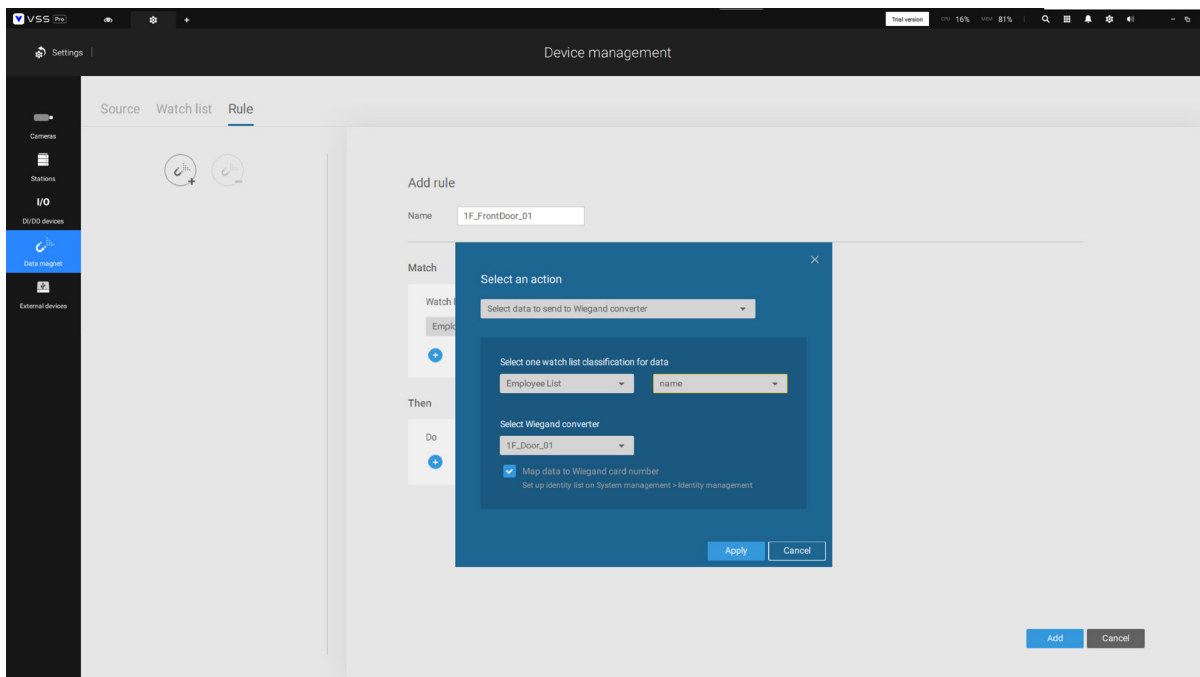

How to add a Wiegand converter to VSS?"

In Settings > External devices > Wiegand Converter, click the add Wiegand converter button. Enter the converter's IP, Port, Output format, and Output length. You can acquire the converter's data via a web console to it.

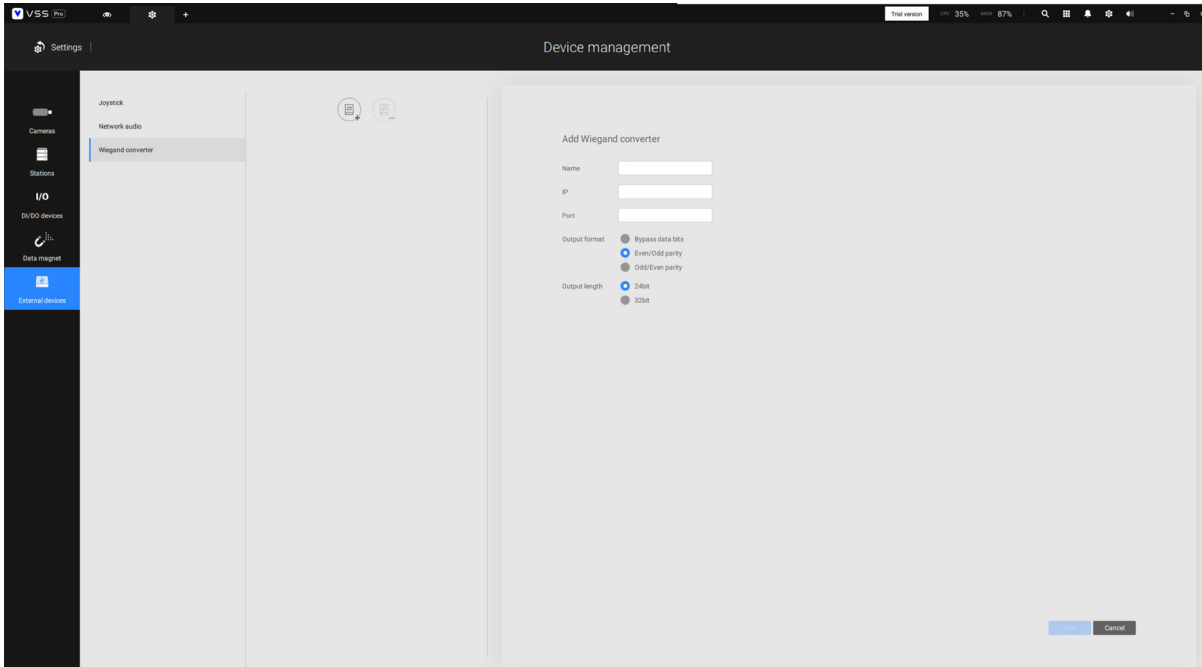

When adding is completed, enter a card number in the Card number field to test if the converter can successfully receive a card number.

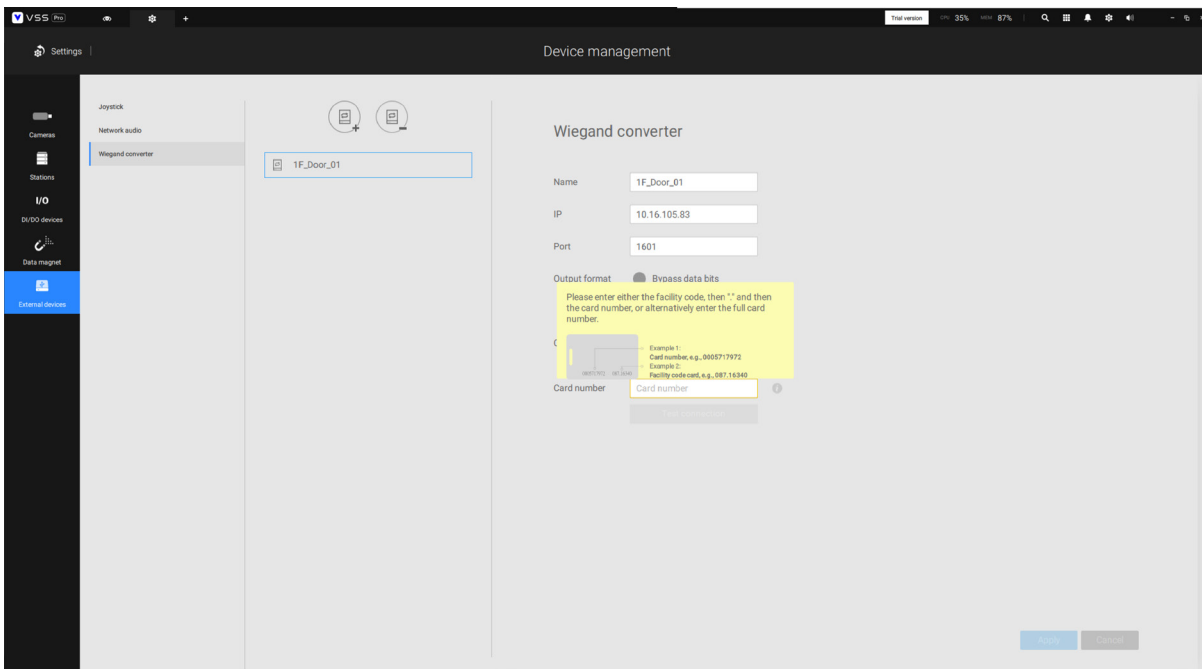

How to configure Identity management?"

In Settings > System > Identity Management, click the add an item button and enter the identity and card number.

Identity is the information such as name or employee ID or car license plate. The Card number is the ID Badge's Wiegand card number.

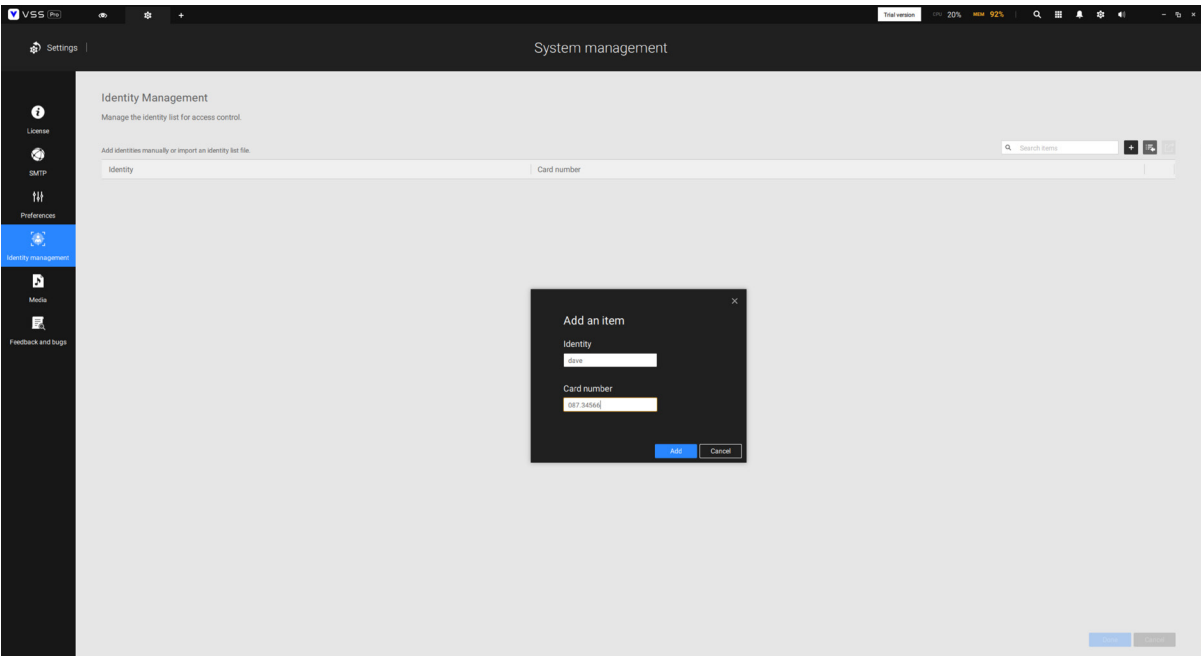
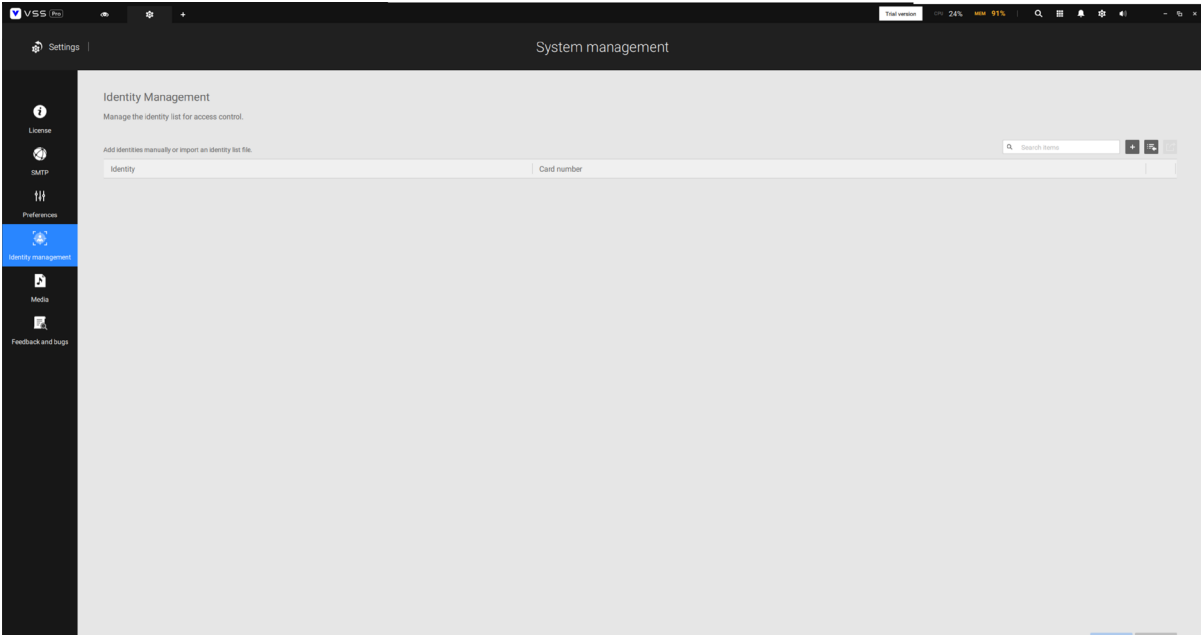

An identity table should look like this.

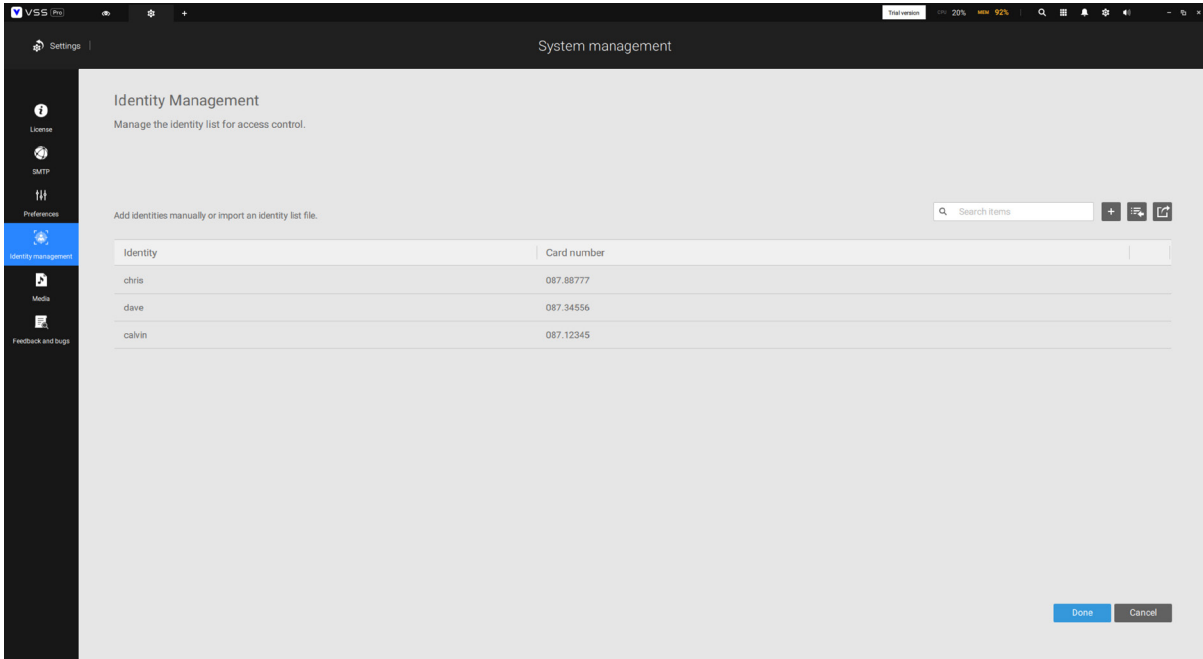

Appendix H: Troubleshooting - Beep Sounds

When you hear the NVR is beeping, you can tell from the following number of beep sounds to know what the issue may be:

Number of beeps	Description
1	Invalid password
4	<ul style="list-style-type: none">• Typically for development use• The beep code is generated when some of the Architectural Protocols are not available.
5	No console input/output device is found.
6	Flash update failed.
7	<ul style="list-style-type: none">• Typically for development use• The beep code is generated when the platform cannot be reset, because the reset protocol is not available.
8	The platform PCI resource requirements cannot be met.

