

HIKVISION

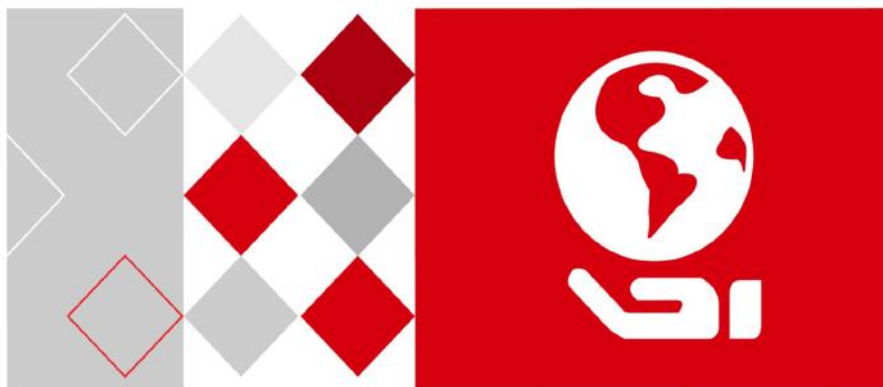

DS-D5032QE

User Manual

User Manual

COPYRIGHT ©2018 Hangzhou Hikvision Digital Technology Co., Ltd.

ALL RIGHTS RESERVED.

Any and all information, including, among others, wordings, pictures, graphs are the properties of Hangzhou Hikvision Digital Technology Co., Ltd. or its subsidiaries (hereinafter referred to be “Hikvision”). This user manual (hereinafter referred to be “the Manual”) cannot be reproduced, changed, translated, or distributed, partially or wholly, by any means, without the prior written permission of Hikvision. Unless otherwise stipulated, Hikvision does not make any warranties, guarantees or representations, express or implied, regarding to the Manual.

About this Manual

This Manual is applicable to the Monitor.

The Manual includes instructions for using and managing the product. Pictures, charts, images and all other information hereinafter are for description and explanation only. The information contained in the Manual is subject to change, without notice, due to firmware updates or other reasons. Please find the latest version in the company website (<http://overseas.hikvision.com/en/>).

Please use this user manual under the guidance of professionals.

Trademarks Acknowledgement

HIKVISION and other Hikvision’s trademarks and logos are the properties of Hikvision in various jurisdictions. Other trademarks and logos mentioned below are the properties of their respective owners.

Legal Disclaimer

TO THE MAXIMUM EXTENT PERMITTED BY APPLICABLE LAW, THE PRODUCT DESCRIBED, WITH ITS HARDWARE, SOFTWARE AND FIRMWARE, IS PROVIDED “AS IS”, WITH ALL FAULTS AND ERRORS, AND HIKVISION MAKES NO WARRANTIES, EXPRESS OR IMPLIED, INCLUDING WITHOUT LIMITATION, MERCHANTABILITY, SATISFACTORY QUALITY, FITNESS FOR A PARTICULAR PURPOSE, AND NON-INFRINGEMENT OF THIRD PARTY. IN NO EVENT WILL HIKVISION, ITS DIRECTORS, OFFICERS, EMPLOYEES, OR AGENTS BE LIABLE TO YOU FOR ANY SPECIAL, CONSEQUENTIAL, INCIDENTAL, OR INDIRECT DAMAGES, INCLUDING, AMONG OTHERS, DAMAGES FOR LOSS OF BUSINESS PROFITS, BUSINESS INTERRUPTION, OR LOSS OF DATA OR DOCUMENTATION, IN CONNECTION WITH THE USE OF THIS PRODUCT, EVEN IF HIKVISION HAS BEEN ADVISED OF THE POSSIBILITY OF SUCH DAMAGES.

REGARDING TO THE PRODUCT WITH INTERNET ACCESS, THE USE OF PRODUCT SHALL BE WHOLLY AT YOUR OWN RISKS. HIKVISION SHALL NOT TAKE ANY RESPONSIBILITIES FOR ABNORMAL OPERATION, PRIVACY LEAKAGE OR OTHER DAMAGES RESULTING FROM CYBER ATTACK, HACKER ATTACK, VIRUS INSPECTION, OR OTHER INTERNET SECURITY RISKS; HOWEVER, HIKVISION WILL PROVIDE TIMELY TECHNICAL SUPPORT IF REQUIRED.

SURVEILLANCE LAWS VARY BY JURISDICTION. PLEASE CHECK ALL RELEVANT LAWS IN YOUR JURISDICTION BEFORE USING THIS PRODUCT IN ORDER TO ENSURE THAT YOUR USE CONFORMS THE APPLICABLE LAW. HIKVISION SHALL NOT BE LIABLE IN THE EVENT THAT THIS PRODUCT IS USED WITH ILLEGITIMATE PURPOSES.

IN THE EVENT OF ANY CONFLICTS BETWEEN THIS MANUAL AND THE APPLICABLE LAW.

Regulatory Information

FCC Information

Please take attention that changes or modification not expressly approved by the party responsible for compliance could void the user's authority to operate the equipment.

FCC compliance: This equipment has been tested and found to comply with the limits for a Class A digital device, pursuant to part 15 of the FCC Rules. These limits are designed to provide reasonable protection against harmful interference when the equipment is operated in a commercial environment. This equipment generates, uses, and can radiate radio frequency energy and, if not installed and used in accordance with the instruction manual, may cause harmful interference to radio communications. Operation of this equipment in a residential area is likely to cause harmful interference in which case the user will be required to correct the interference at his own expense.

FCC Conditions

This device complies with part 15 of the FCC Rules. Operation is subject to the following two conditions:

1. This device may not cause harmful interference.
2. This device must accept any interference received, including interference that may cause undesired operation.

EU Conformity Statement



This product and - if applicable - the supplied accessories too are marked with "CE" and comply therefore with the applicable harmonized European standards listed under the EMC Directive 2014/30/EU, the LVD Directive 2014/35/EU, the RoHS Directive 2011/65/EU.



2012/19/EU (WEEE directive): Products marked with this symbol cannot be disposed of as unsorted municipal waste in the European Union. For proper recycling, return this product to your local supplier upon the purchase of equivalent new equipment, or dispose of it at designated collection points. For more information see: www.recyclethis.info



2006/66/EC (battery directive): This product contains a battery that cannot be disposed of as unsorted municipal waste in the European Union. See the product documentation for specific battery information. The battery is marked with this symbol, which may include lettering to indicate cadmium (Cd), lead (Pb), or mercury (Hg). For proper recycling, return the battery to your supplier or to a designated collection point. For more information see: www.recyclethis.info

Industry Canada ICES-003 Compliance

This device meets the CAN ICES-3 (A)/NMB-3(A) standards requirements.

 **WARNING**

To prevent injury, this apparatus must be securely attached to the floor/wall in accordance with the installation instructions.

Applicable Models

This manual is applicable to the model: LCD Monitor.

Symbol Conventions

The symbols that may be found in this document are defined as follows.



Symbol	Description
 NOTE	Provides additional information to emphasize or supplement important points of the main text.
 WARNING	Indicates a potentially hazardous situation, which if not avoided, could result in equipment damage, data loss, performance degradation, or unexpected results.
 DANGER	Indicates a hazard with a high level of risk, which if not avoided, will result in death or serious injury.

TABLE OF CONTENTS

- Safety instructions 5
 - Screen maintenance 8
- Operation Instructions 9
 - Control panel..... 9
 - Remote control..... 10
- Installation instructions 11
 - Control button and joint..... 12
 - How to adjust the settings..... 13
 - Adjust the image settings..... 14
- Technical support (common problems)..... 16
- Appendix..... 19
 - Specification..... 19
 - Comparison table of the preset frequencies of the original factory 20
 - Instructions of the joint pin 21

Safety instructions

Pixel feature

This liquid crystal display product has ultrahigh color resolution. While it's effective pixels are up to 99.999% or higher, it is still possible that a dark spot or a bright spot (red, green or blue) constantly appears on the screen. This is the structure property (within the general industrial standard) of the display rather than a fault.

Safety

Please read and understand all instructions before using the monitor safety . Damage resulting from nonobservance of the instructions is not covered by the warranty.

Be careful of electric shock and fire!

- Never make the monitor contact with rain or water. Never place a liquid container (e.g., a vase) near or on the monitor. Please disconnect the monitor's power immediately if a liquid is spilled on the monitor's surface or inside. Please contact the customer service center before using it again.
- Never put a monitor, remote controller, or battery near an open flame or other heat source (including direct sunlight). In order to avoid flame spread, always keep candles or other open flames away from monitors, remote controls, and batteries.



- Never insert any object into the ventilation slot or other openings on the monitor.
- Please make sure that the power line is not taut. The tightening of the power line will loose the power connections and produce sparks.

Beware of short circuit or fire!

- Do not expose the remote controller or battery in rain, water or overheated environment.
- Please avoid pulling the plug. Loose power plugs may spark or cause fire.

Watch out for personal injury or monitor damage!

- It is suggested that the monitor be carried by two people.
- When installing the monitor on the stand, please use only the chassis provided. Firmly fix the frame on the monitor. Put the monitor on a flat, flat surface that can withstand the total weight of the monitor and the chassis.
- When installing a monitor with wall mounting, please use only the wall mount bracket that can bear the weight of the monitor. Fix the wall mount mounting bracket on the wall that can withstand the total weight of the monitor and the wall mount bracket.

The company is not responsible for the accident, personal injury or loss caused by improper installation.

Be careful of hurting children!

Please follow the following precautions to avoid child injury due to monitor falling:

- Never place the monitor on a surface covered with a cloth or other material that can be pulled.
- Make sure that any part of the monitor is within the edge of the surface.
- When placing a monitor on a high furniture (such as a bookcase), the furniture and monitor must be fixed to the wall or the appropriate support.
- Tell children about the dangers of climbing furniture and touching monitors.

Beware of eating battery!

- The remote control of this product contains batteries. There is a risk that children might eat the batteries. Please keep them out of reach of children.

Watch out for overheating!

- Never install the monitor in the enclosed space. Always leave at least 4 inches or 10 centimeters of space around the monitor for ventilation. Make sure that curtains or other objects do not block the ventilation slot on the monitor.

Be careful! Don't break the monitor!

- Before you connect the monitor to the power outlet, make sure that the power voltage matches the value printed on the back of the monitor. If the voltage is different, don't connect the monitor to the power outlet.
- If the monitor is not used for a long time, please cut off the power supply.

Be careful of personal injury, fire or power line damage!

- Do not put the monitor or any object on the power line.
- As a disconnecting device, the power plug should be kept to operate conveniently.
- When the power line is disconnected, always hold the plug instead of pulling the cable.
- Before the thunderstorm comes, disconnect the monitor from the power outlet and the antenna. Never touch any part of a monitor, a power line, or an antenna in a thunderstorm.
- The wired network antenna connected to the equipment must be isolated from the protective grounding, otherwise it may cause fire and other dangers!

Watch out for hearing impairment!

- Avoid using headphones or earphones at high volume or for a long time.

Low temperature

- If the monitor is transported below 5° C, please open the package of the monitor. Wait for the monitor to adapt to the room temperature, and then connect the monitor to the power outlet.

Screen maintenance

Before using the monitor, please read and understand all the instructions. Damage resulting from nonobservance of the instructions is not covered by the warranty.

- Try to avoid still images. A still image means that an image stays on the screen for a long time. Still image may cause permanent damage to the monitor screen;
- the monitor screen to cause image blur, afterimage, local traces, and the display is not within the scope of warranty
- Don't display static images for more than 2 hours on the LCD monitor, because it will cause the screen image blur. In order to avoid this problem please reduce the brightness and contrast of the screen in the display of a still image.
- When you watch 4:3 programs for a long time, you leave different marks on the left and right sides of the screen and the edges of the image, so please don't use this mode for a long time.
- Image sticking may occur if playing video games or displaying still images for a long time. It is caused by screen burn. Please reduce brightness and contrast when appropriate.
- Pull out the monitor plug before cleaning.
- Use a soft dry cloth to wipe the monitor and frame. Do not use alcohol, chemicals or household cleaning agent cleaning monitor.
- Watch out for damage to monitor screen! Do not use any object to contact, push, rub or tap the screen.
- In order to avoid deformation and fading, please wipe water as soon as possible.

Operation Instructions

Control panel

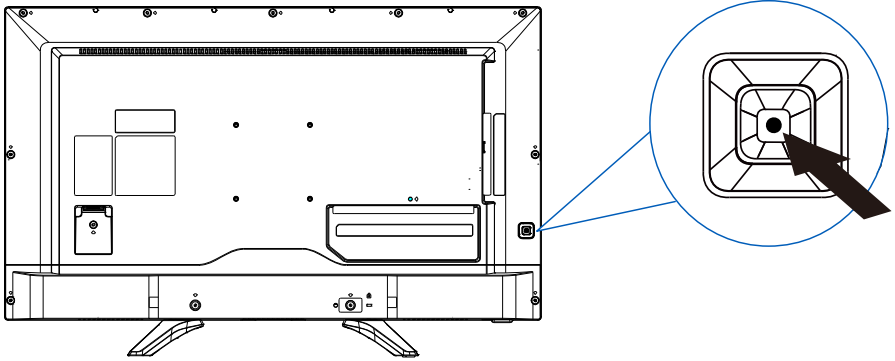

(The shape of the product will vary between models, please take the actual machine as the standard!)

Power/ Input	Press the Power key in the shutdown state. Short-press to select VGA/HDMI and long-press to shut it off in the power-on state.
-----------------	--

Remote control

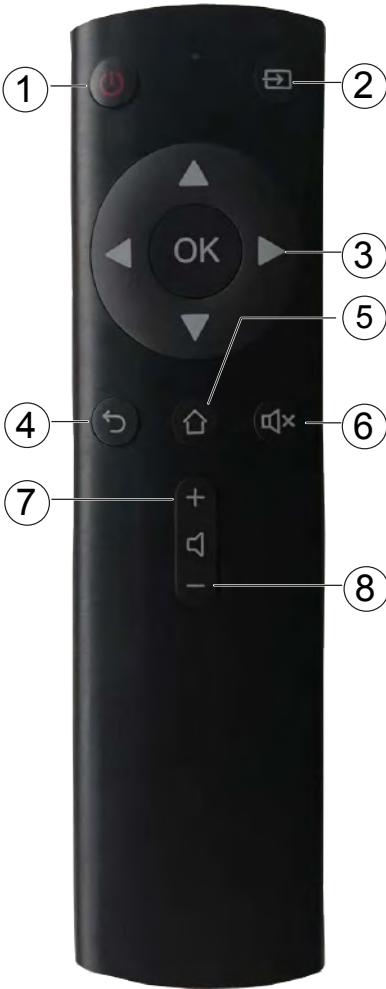

1. Standby-Power on
When the monitor boot, it can be switched to standby.
The monitor can be power on when it is in standby mode.
2. Signal source
Opens the signal source menu, select the connected device.
3. Button
Up, down, left and right operation key & confirmation key.
4. Return
Return to the previous menu or exit the application.
5. Homepage menu key
Enter the home page menu.
6. Mute
Mute/Unmute.
- 7/8. Volume key
Adjust the volume.

Installation instructions

Connect the base:

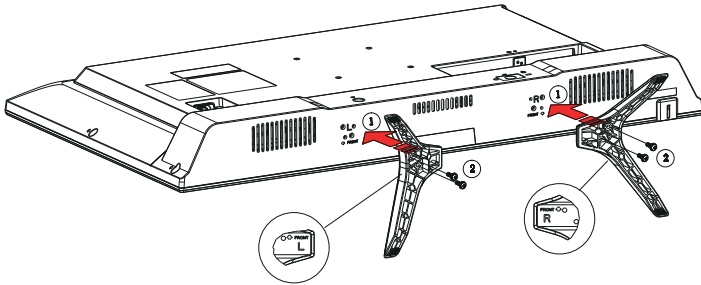

Remove the base:

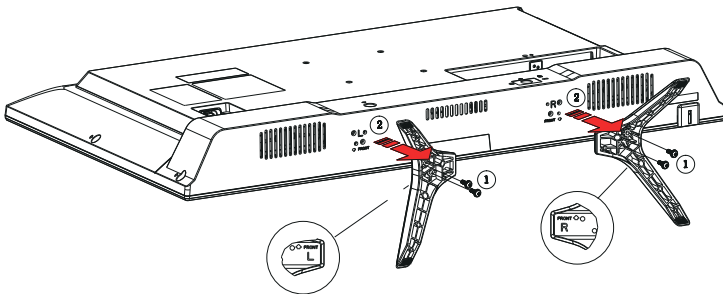

Power Cord

Power Supply:

1. Please use the power cord applicable to the local region.
2. The LCD is internally configured with a power board, capable of being used in regions with 100/120V AC or 220/240V AC voltage (It is not necessary to perform adjustments by yourself).

Control button and joint

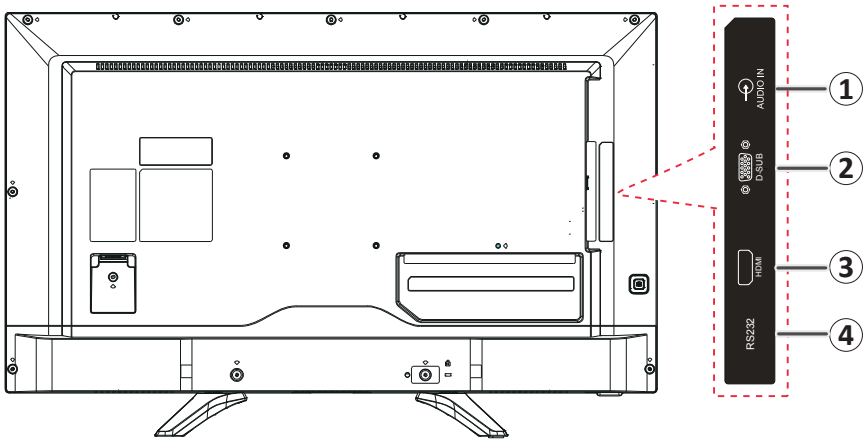

Signal wire

- **Connect the VGA wire:** Connect the 15 -pin **VGA** signal wire to the back of the display and the **VGA** port of the computer or other devices.
- **Connect the HDMI wire:** Connect the 19 -pin **HDMI** signal wire to the back of the display and the **HDMI** port of the computer or other devices.
- **Connect power cord:** Connect the power cord to the **AC jack** on the back of the display.

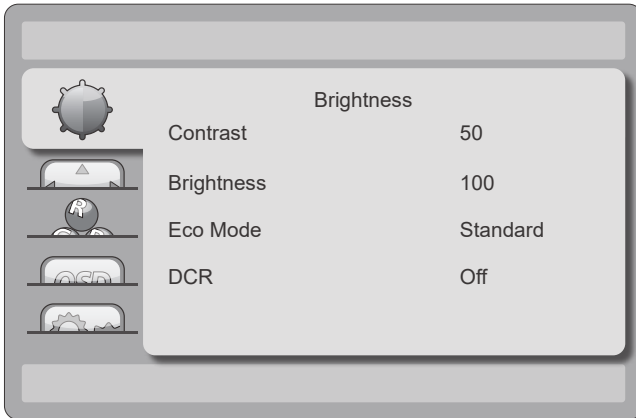

1.	Audio in
2.	D-SUB
3.	HDMI signal input
4.	RS232 (Serial port communication control)

How to adjust the settings



1. Press the button “



The image shows a screenshot of an OSD (On-Screen Display) menu. On the left side, there is a vertical list of icons: a gear, a left arrow, a right arrow, a globe, a DCR icon, and another gear. The right side of the screen displays a table of settings:

	Brightness	
Contrast		50
Brightness		100
Eco Mode		Standard
DCR		Off

Adjust the image settings

Description of the functions of control button:

Main menu item	Main menu picture	Sub-menu item	Sub-menu	Description
Brightness		Contrast	-	Comparison of digital register
		Brightness	-	Backlight adjustment
		Eco Mode	Standard	Standard mode
			Text	Text mode
			Internet	Internet mode
			Game	Game mode
			Movie	Movie mode
			Sports	Sports mode
		DCR	On	Enable the DCR functions
			Off	Disable the DCR functions
Image Setup		Clock		Adjust the image "Clock" to reduce the noises on the vertical line
		Phase		Adjust the image "Phase" to reduce the noises on the horizontal line
		H. Position		Adjust the horizontal position of the image
		V. Position		Adjust the vertical position of the image
		Image Ratio	Wide 4:3	Select the image ratio

Main menu item	Main menu picture	Sub-menu item	Sub-menu	Description	
Color Temp.		Warm		Called back from EEPROM “Warn” setup	
		Normal		Called back from EEPROM “Normal” setup	
		Cold		Called back from EEPROM “Cold” setup	
		User	Red		Red gain of the digital cache
			Green		Green gain of the digital cache
Blue			Blue gain of the digital cache		
OSD setup		H. Position	-	Adjust the horizontal direction of the OSD.	
		V. Position	-	Adjust the vertical direction of the OSD.	
		Timeout	-	Adjust the display time of the OSD.	
		Language	-	Select a language for the OSD.	
Extra		Input Select	Auto/ D-SUB/ HDMI	Select the input source.	
		DDC/CI	On or Off	“On/Off DDC/CI ” supporting functions	
		Reset	Yes or No	Reset the menu by default	
		Information	-	Display the information of the main image signal source	

Plug-and-play

Plug-and-play DDC2B function

This display is configured with the VESA DDC2B function in accordance with the “VESA DDC standard”. According to the different DDC use grades, the display can inform the host of its identification information and transmit other related information of the display function.

The DDC2B is a double data channel based on the IC communication protocol. The host can require the EDID information through the DDC2B.

In the case of no video input signal, the functions of this panel cannot be used. In order to normally operate the display, the video input signal is a must.

Technical support (common problems)

Problems	Feasible solution
“Plug-and-play” function does not work	<ul style="list-style-type: none">• Please check if the computer system is compatible with “Plug-and-play” function.• Please check if the display adapter is compatible with “Plug-and-play” function.
Fuzzy image	<ul style="list-style-type: none">• Please adjust the “Contrast” and “Brightness”.
Jitterbug or ripple	<ul style="list-style-type: none">• Remove electrical devices that can cause electric interference.
Lacking one of the elementary colors (red, green or blue)	<ul style="list-style-type: none">• Inspect the video connecting wire of the display, and determine if there is any pin bent.
Image deviation from the center of the display or size error	<ul style="list-style-type: none">• Please adjust the pixel (frequency), “Phase”, or press the shortcut key (automatic).

Problems	Feasible solution
Flawed image color (the white color does not look white)	<ul style="list-style-type: none"> • Please adjust the RGB color or select color temperature.
Poor brightness or contrast	<ul style="list-style-type: none"> • When the display fades in brightness and affects the display function after being used for a period of time, please hand the display to a qualified repair center for repair.
The display has horizontal or vertical interference	<ul style="list-style-type: none"> • Please adjust “Frequency” and “Phase” or execute the shortcut key (automatic button).

“Clock” (pixel frequency) can control the pixels scanned by a single horizontal scanner. In the case of frequency error, vertical strips appear on the display, and an abnormal image ratio will be caused.

“Phase” can be used to adjust the phase of the pixel frequency signal. In the case of correcting the wrong phase, horizontal interference will appear in the brighter image.

Error information and feasible solution

No signal

1. Please check if the signal wire is well connected. If the connector is loose, please fasten the screw on the joint.
2. Please check whether the connecting pin of the signal wire is damaged.

Does not support input signal

Incorrect display mode setup of the computer. Please refer to the display modes in the specification table to perform setting.

Appendix

Specification

LCD panel	Drive system	32" TFT color LCD
	Dimension	812 mm diagonal line
	Pixel distance	0.36375mm(H) × 0.36375mm(V)
Input	Video signal	Digital/analog
	Horizontal frequency	30kHz – 83kHz
	Vertical frequency	56 – 75Hz
Display color		16.7M
Maximum resolution		1920 x 1080@60Hz
Plug-and-play		DDC 1/2B/CI or VESA DDC2B™
Power consumption	Standby power consumption (standby)	< 0.5W
	Shutdown power consumption (shutdown)	< 0.5W
	Startup power consumption	54W (max.) 35W (classic)
Input joint		15-pin D-Sub, 19-pin HDMI
Input video		Digital/analog
Maximum display dimension		Horizontal 698.4 mm Vertical: 392.9 mm
Power Supply		100-240 VAC, 50/60Hz
Operating environmental conditions		Operating temperature: 0° to 40°C Storage temperature: -20° to 60°C Operating humidity: 10% to 85% Storage humidity: 5% to 80%
Dimension (W x H x D)		Without base: 726.49(W)x424.26(H) x79.8(D) mm With base: 726.49(W)x474.26(H)x79.8(D) mm
Weight (net weight)		5.09kg

Comparison table of the preset frequencies of the original factory

PC mode resolution

Standard	Resolution	Refresh rate
VGA	640 × 480	60Hz
VGA	640 × 480	67Hz
VGA	640 × 480	75Hz
WVGA	720 × 400	70Hz
SVGA	800 × 600	60Hz
SVGA	832 × 624	75Hz
XGA	1024 × 768	60Hz
WXGA	1152 × 870	75Hz
WXGA	1280 × 720	60Hz
SXGA	1280 × 1024	60Hz
WXGA	1440 × 900	60Hz
UXGA	1600 × 900	60Hz
UXGA	1680 × 1050	60Hz
HD1080	1920 × 1080	60Hz
WXGA	1366 × 768	60Hz

HDMI video mode resolution

Standard	Resolution	Refresh rate
1080 P 59.94/60Hz	1920 × 1080	60Hz
1080 P 50Hz	1920 × 1080	50Hz
1080 P 29.97/30Hz	1920 × 1080	30Hz
1080 P 25Hz	1920 × 1080	25Hz
1080 P 23.97/24Hz	1920 × 1080	24Hz
1080 I 59.94/60Hz	1920 × 1080	60Hz
1080 I 50Hz 16:9	1920 × 1080	50Hz
720 P 50Hz 16:9	1280 × 720	50Hz
720 P 59.94/60Hz	1280 × 720	60Hz
576 I 50Hz 4:3	720 × 576	50Hz
576 I 50Hz 16:9	720 × 576	50Hz
480 I 59.94/60Hz	720 × 480	60Hz
576 P 50Hz 4:3	720 × 576	50Hz
576 P 50Hz 16:9	720 × 576	50Hz
480 P 59.94/60Hz	720 × 480	60Hz
480 P 59.94/60Hz	720 × 480	60Hz

Instructions of the joint pin

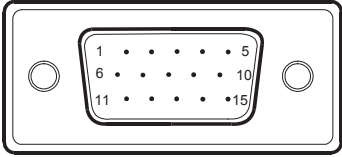

15-Pin colorful display signal wire

Pin No.	Function	Pin No.	Function
1.	Red	9.	+5V Power supply
2.	Green	10.	Grounded
3.	Blue	11.	Grounded
4.	Grounded	12.	DDC-sequence data
5.	Sensing wire	13.	Horizontal synchronization
6.	R-grounded	14.	Vertical synchronization
7.	G-grounded	15.	DDC-sequence clock
8.	B-grounded		



19-Pin colorful display signal wire

Pin No.	Function	Pin No.	Function
1.	TMDS data 2+	11.	TMDS clock cover
2.	TMDS data 2 cover	12.	TMDS clock
3.	TMDS data 2	13.	CEC
4.	TMDS data 1+	14.	Reserved (the device is not used)
5.	TMDS data 1 cover	15.	SCL
6.	TMDS data 1	16.	SDA
7.	TMDS data 0+	17.	DDC/CEC ground
8.	TMDS data 0 cover	18.	+5V Power supply
9.	TMDS data 0	19.	Hot-plug test
10.	TMDS clock +		



海康威视客户服务



海康威视官方网站

杭州海康威视数字技术股份有限公司
HANGZHOU HIKVISION DIGITAL TECHNOLOGY CO., LTD.

www.hikvision.com
服务热线：400-700-5998