

VIVOTEK

A Delta Group Company

RX9502 H.265 Video Receiver

User's Manual

H.265/H.264 • 32 CH • HDMI • ONVIF

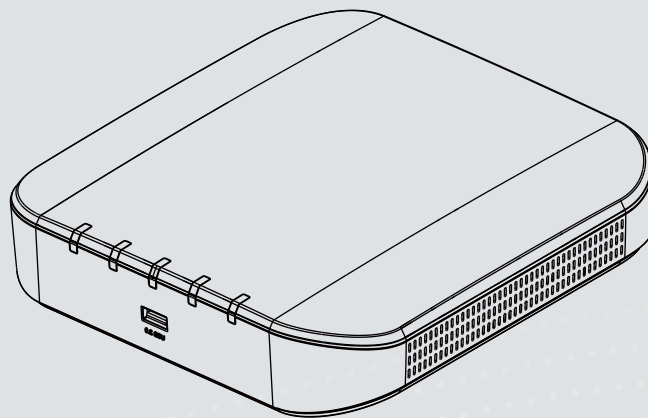

Rev. 1.0

Table of Contents

Chapter One Hardware Installation and Initial Configuration	7
Introducing the Network Video Recorder	7
Special Features	8
Safety	8
Chassis Dimensions	9
Physical Description	10
Topology	11
Hardware Installation	12
Interface Connections	13
Initial Configuration - via a Local Console	14
Initial Configuration - via a Web Console (Optional)	17
LED Indicators	19
Power Up and Power Down	20
Section One Management over a Local Console	21
Chapter Two Introduction to the Local Console Interface	21
2-1. How to Begin	23
2-2. Operation on a Camera View Cell	27
2-2-1. PTZ Panel	27
2-2-2. Digital Zoom Panel	31
2-2-3. Others	32
2-2-4. Right-click Commands	33
Chapter Three Configuration Using the Local Console	34
The Main Control Portal	34
3-1. Layout	34
3-2. Settings	35
3-2-1. Settings - Overview	35
3-2-2. Settings - Camera - Management	36
3-3-1. Settings—Camera—Media	44
3-3-2. Settings - System - Information	51
3-3-2. Settings - System - Maintenance	52
3-3-3. Settings - System - Display	53
3-4. Settings - User	54
3-4-1. Login / Logout	55
3-5. Settings - Network	56
Settings - Network - IP	56
Settings - DDNS	57
Settings - Service	58
3-6. HTTPS certificate	62
3-7. User	63
Settings—User-Login / Logout	65
3-8. Information	66
Section Two Management over a Web Console	67

Safety and Compatibility..... 70

Revision History

* Rev. 1.0: Initial release.



IMPORTANT:

Some low quality Ethernet cables with smaller core diameter can seriously reduce the transmission rate. Use CAT5e or CAT6 cables with a wire gauge of 24AWG for Receiver's uplink port. A thicker core 24 AWG network cable can offer less resistance than a 26 AWG or 28 AWG network cable.

Use shielded cables in high noise environments where cross talk and EMI can occur.

The product name tag and MAC address is here.

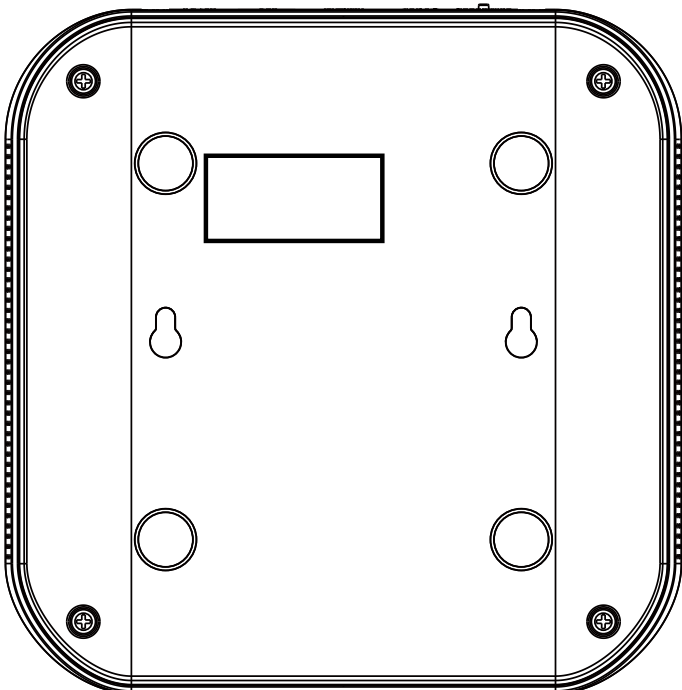

Technology License Notice



Notices from HEVC Advance:

THIS PRODUCT IS SOLD WITH A LIMITED LICENSE AND IS AUTHORIZED TO BE USED ONLY IN CONNECTION WITH HEVC CONTENT THAT MEETS EACH OF THE THREE FOLLOWING QUALIFICATIONS: (1) HEVC CONTENT ONLY FOR PERSONAL USE; (2) HEVC CONTENT THAT IS NOT OFFERED FOR SALE; AND (3) HEVC CONTENT THAT IS CREATED BY THE OWNER OF THE PRODUCT. THIS PRODUCT MAY NOT BE USED IN CONNECTION WITH HEVC ENCODED CONTENT CREATED BY A THIRD PARTY, WHICH THE USER HAS ORDERED OR PURCHASED FROM A THIRD PARTY, UNLESS THE USER IS SEPARATELY GRANTED RIGHTS TO USE THE PRODUCT WITH SUCH CONTENT BY A LICENSED SELLER OF THE CONTENT. YOUR USE OF THIS PRODUCT IN CONNECTION WITH HEVC ENCODED CONTENT IS DEEMED ACCEPTANCE OF THE LIMITED AUTHORITY TO USE AS NOTED ABOVE.

H.264

THIS PRODUCT IS LICENSED UNDER THE AVC PATENT PORTFOLIO LICENSE FOR THE PERSONAL AND NON-COMMERCIAL USE OF A CONSUMER TO (i) ENCODE VIDEO IN COMPLIANCE WITH THE AVC STANDARD ("AVC VIDEO") AND/OR (ii) DECODE AVC VIDEO THAT WAS ENCODED BY A CONSUMER ENGAGED IN A PERSONAL AND NON-COMMERCIAL ACTIVITY AND/OR WAS OBTAINED FROM A VIDEO PROVIDER LICENSED TO PROVIDE AVC VIDEO. NO LICENSE IS GRANTED OR SHALL BE IMPLIED FOR ANY OTHER USE. ADDITIONAL INFORMATION MAY BE OBTAINED FROM MPEG LA, L.L.C. SEE [HTTP://WWW.MPEGLA.COM](http://www.mpegla.com)



Read Before Use

The use of surveillance devices may be prohibited by law in your country. The Network Video Receiver is not only a high-performance web-ready camera but can also be part of a flexible surveillance system. It is the user's responsibility to ensure that the operation of such devices is legal before installing this unit for its intended use.

It is important to first verify that all contents received are complete according to the Package Contents listed below. Take note of the warnings in the Quick Installation Guide before the Network Video Receiver is installed; then carefully read and follow the instructions in the Installation chapter to avoid damage due to faulty assembly and installation. This also ensures the product is used properly as intended.

The Network Video Receiver is a network device and its use should be straightforward for those who have basic networking knowledge. It is designed for various applications including video sharing, general security/surveillance, etc. The Configuration chapter suggests ways to best utilize the Network Video Receiver and ensure proper operations. For creative and professional developers, the URL Commands of the Network Video Receiver section serves as a helpful reference to customizing existing homepages or integrating with the current web server.



NOTE:

The operating system and management software are installed on a flash memory mounted on the main board. Except for the plug-ins for the onscreen control, there is no need to install software.

Package Contents

<ul style="list-style-type: none"> ■ RX9502 ■ Power adapter 	<ul style="list-style-type: none"> ■ Mouse ■ Quick Installation Guide
-------------------------------------------------------------------------------------	-----------------------------------------------------------------------------------------------

Symbols and Statements in this Document



INFORMATION: provides important messages or advices that might help prevent inconvenient or problem situations.



NOTE: Notices provide guidance or advices that are related to the functional integrity of the machine.



Tips: Tips are useful information that helps enhance or facilitate an installation, function, or process.



WARNING! or IMPORTANT: These statements indicate situations that can be dangerous or hazardous to the machine or you.



Electrical Hazard: This statement appears when high voltage electrical hazards might occur to an operator.

Chapter One Hardware Installation and Initial Configuration

Introducing the Network Video Recorder

VIVOTEK's RX9502 is an H.265 Single-Channel Ultra-HD Video Receiver. Delivering high-quality and detailed images, it is equipped for up to 32-CH network cameras and a maximum network camera resolution of 8-Megapixels. The machine can drive an HD monitor directly via HDMI, and supports decode options of 4K 30 fps, four H.265 1080p 120 fps, nine H.265 720p 270 fps, or sixteen H.265 D1 480 fps. The machine offers a more cost-effective and PC alternative solution with no costly VMS client fee, no HDD noise and no failure issues. It is suitable for standalone viewers through local viewing. Secured and simplified IT management reduce the requirement for end user training, further reducing long-term costs.

Space-saving, Flexible Installation

Compact size with fanless design for any small scale video surveillance installation, the model is perfect for a single display application that requires space-saving solutions. For more flexible installation, it supports, wall or desktop mount options.

Various Split-window Layout & Fisheye Dewarp Support

The machine provides various split modes for layout display (1x1, 2x2, 3x3, 1P+3, 2P+3, 1M+5, 1P+6, 3V, 1M+12, 1M+31, 4x4) and supports VIVOTEK's fisheye camera Fisheye Dewarp function, which provides multiple de-warping modes to ensure the correct angle of video view and detailed information for flexible usage.

Special Features

● Runs on embedded Linux	● Fisheye Dewarp
● 1 x HDMI for local display up to 4K resolution	● Supports cameras of up to 20MP resolution
● Up to 32 Channel IP Camera Input	● ONVIF Compliance (Project Support Function)
● 1 x Gigabit RJ45 uplink Ethernet port;	● Supports Various Split-window Layout Display Modes
● 2 x USB Port (1 in Front / 1 USB 3.0 in Back)	● Snapshot / Export Media
● Size: 198 mm (W) x 200 mm (D) x 47 mm (H)	● PiP Video Control
● One Button Auto Setup	● Configuration Backup / Restore

- [Compatible with VIVOTEK VSS Central Management Software*](#)

Safety

- Connect the system to an earthed main power outlet.
- Never open the housing of the power supply unit.
- Install and operate the system only in a dry, weather-proof location.
- Observe the following safety factors:
 - Is there visible damage to the system or power cord?
 - Is the system operating correctly?
 - Has the system been exposed to rain or moisture?
 - Has the system been in a long storage under harsh conditions or exposed to unconfirming stress?
- The relevant electrical engineering regulations must be complied with at all times during the installation.
- Ensure that all maintenance and repair work is handled by qualified personnel such as electrical engineers or network specialists.
- Read this manual before installing or operating the system. The documentation contains important safety instructions about permitted uses.
- The rated AC input is: **100-240V~ 1A, 60-50Hz**; the max. consumption: **11W** (DC12V, 0.9A)
- If a fault occurs, disconnect the power cord from the power supply.
- Do not install the system close to heaters or other heat sources. Avoid locations with direct sunlight.
- All ventilation openings must not be blocked.
- Use only the cables shipped with system or use appropriate cables that can withstand electromagnetic interference.

Chassis Dimensions

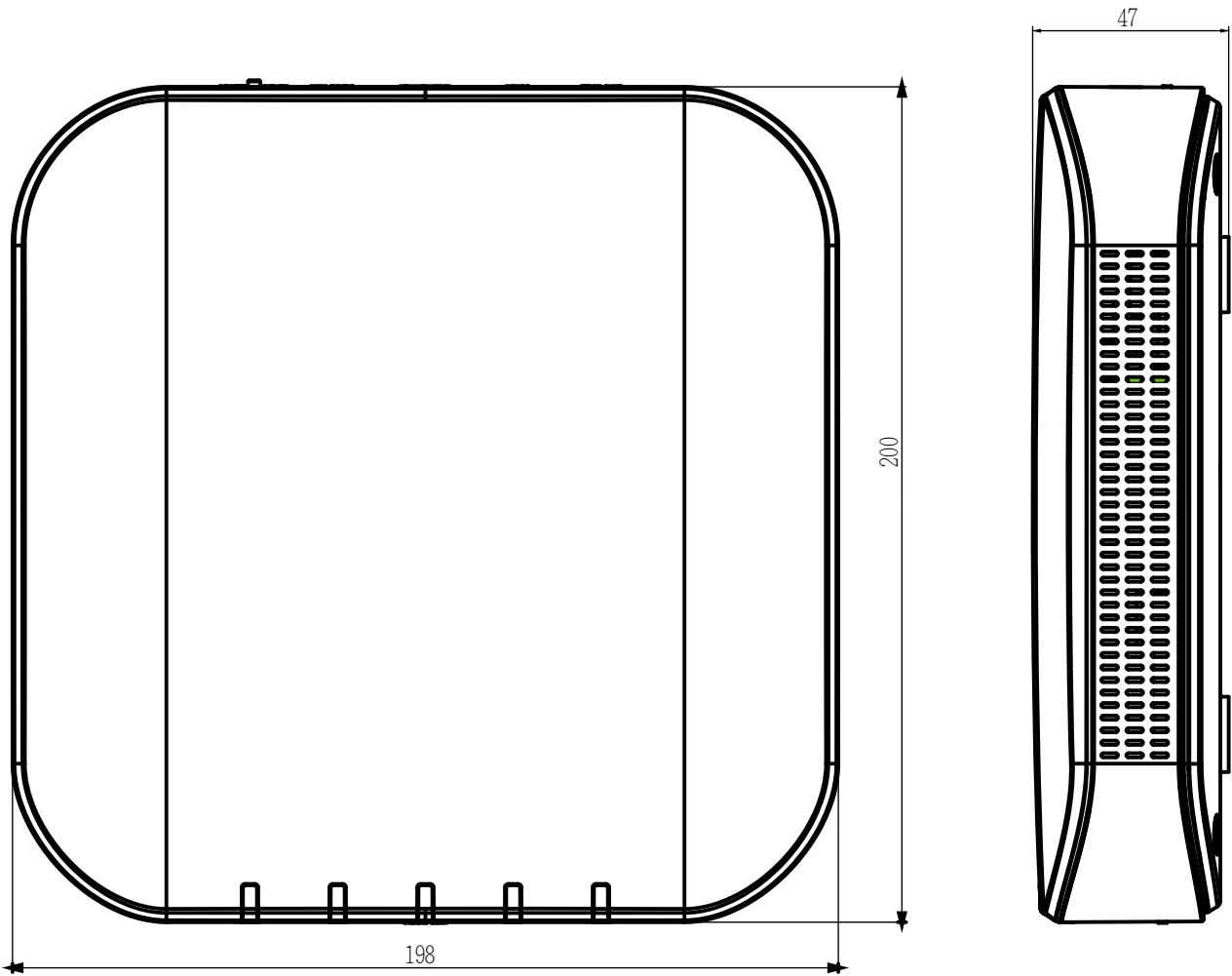

M4x10 for wall-mounting

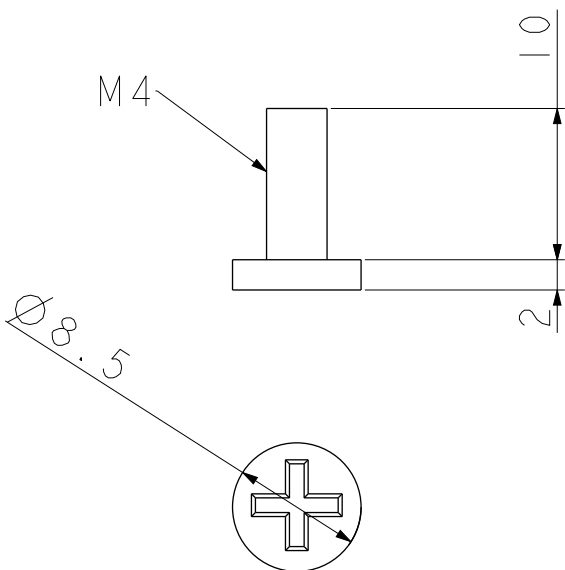

SCALE 2:1

1 Physical Description

● Front View

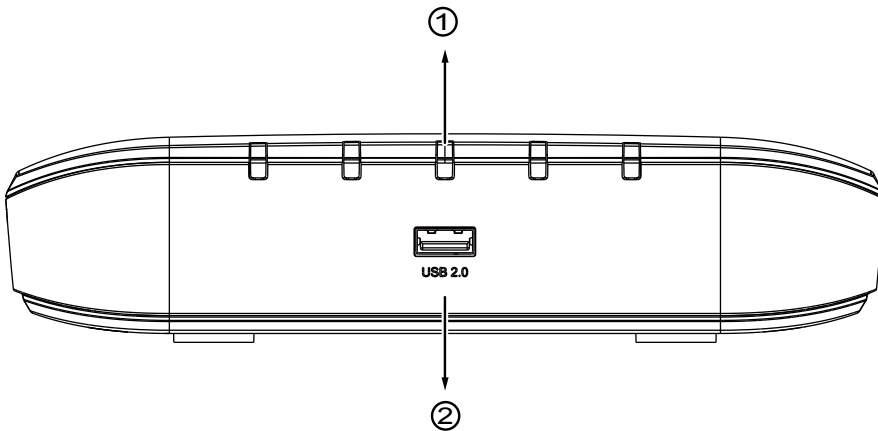

1	Activity LED: Please refer to page 19 for LED definitions.
2	USB 2.0 port

● Rear View

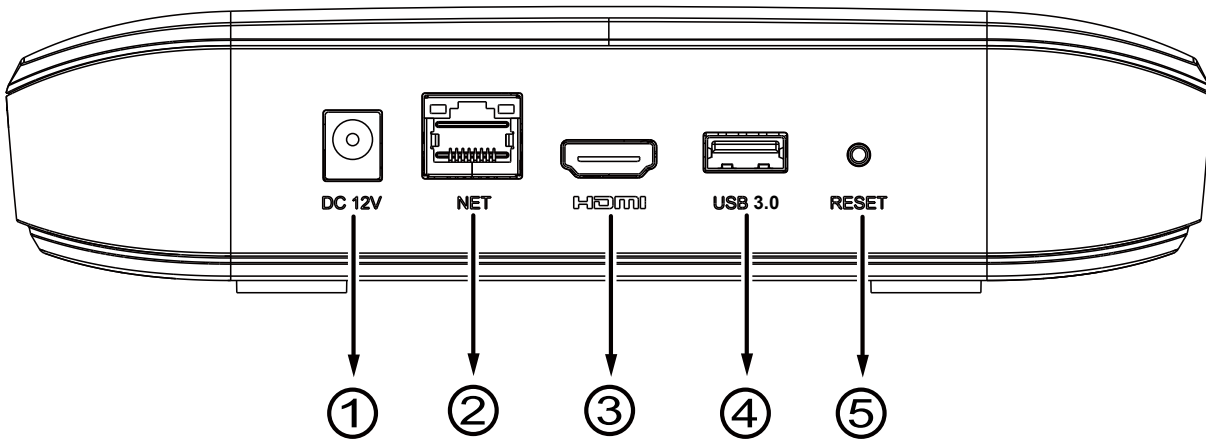

1	Power socket (DC12V, 1A)	4	USB 3.0 port
2	10/100/1000Mbps uplink port	5	Reset button
3	HDMI		

⚠ IMPORTANT:

It is important to leave a clearance of 10cm around the chassis. The clearance is required to ensure an adequate airflow through the chassis to ventilate heat.

To ensure normal operation, maintain ambient airflow. Do not block the airflow around chassis such as placing the system in a closed cabinet.

2 Topology

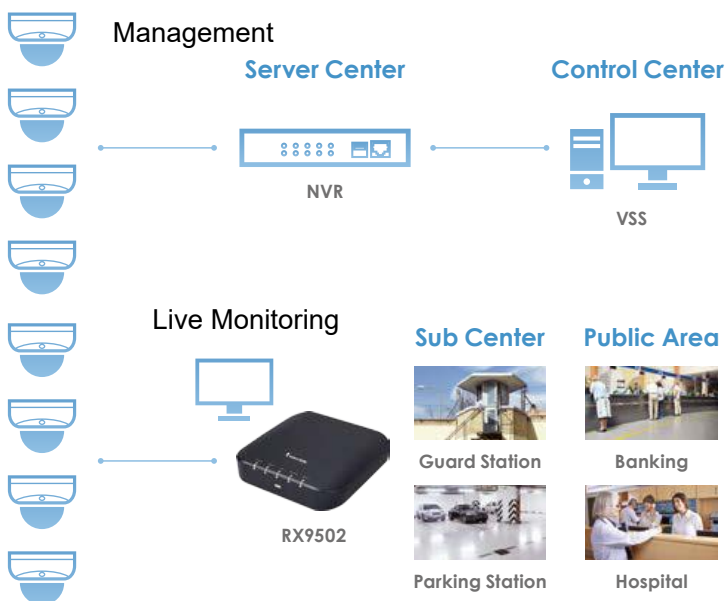
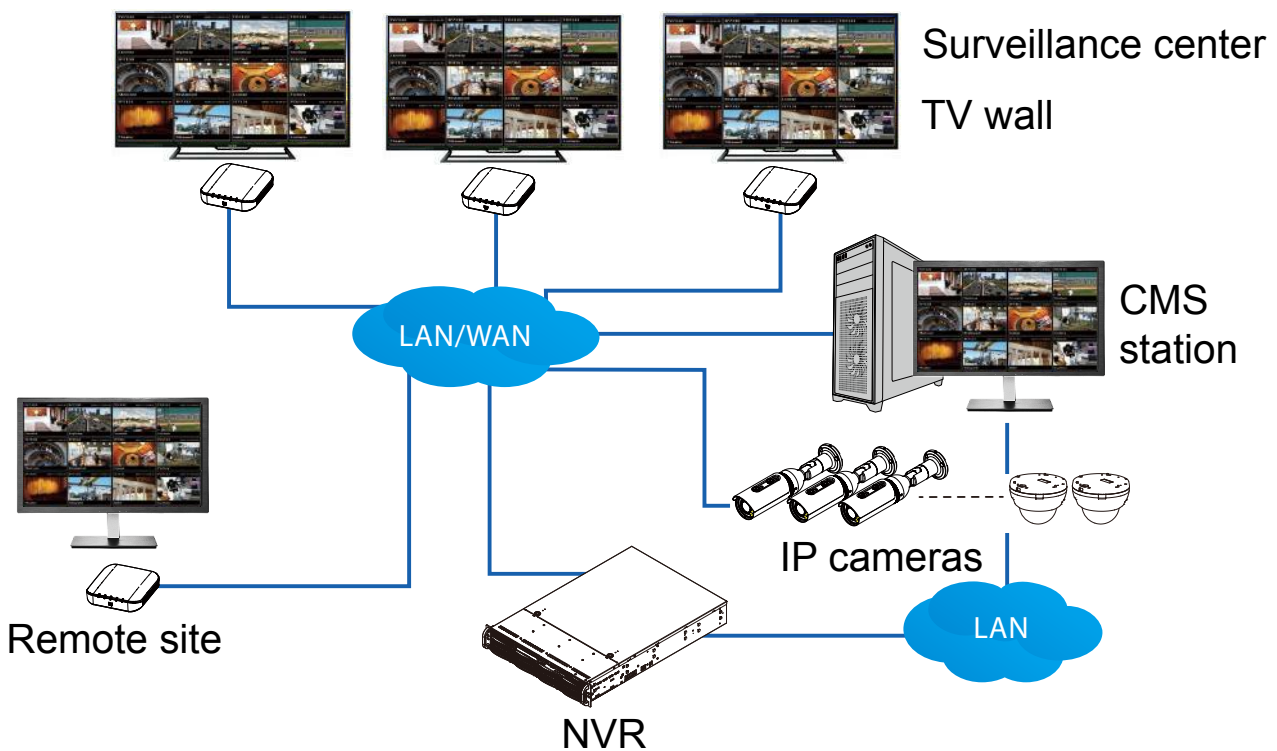

3 Hardware Installation

1. Connect a mouse and/or keyboard to the USB connectors at the front or the rear of the receiver.

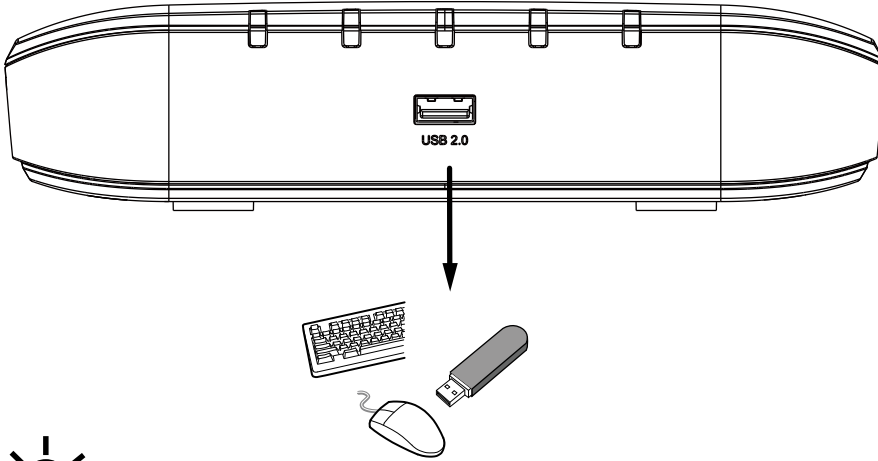

If you prefer to hang the Receiver on wall, drill and install two screws 104mm apart.

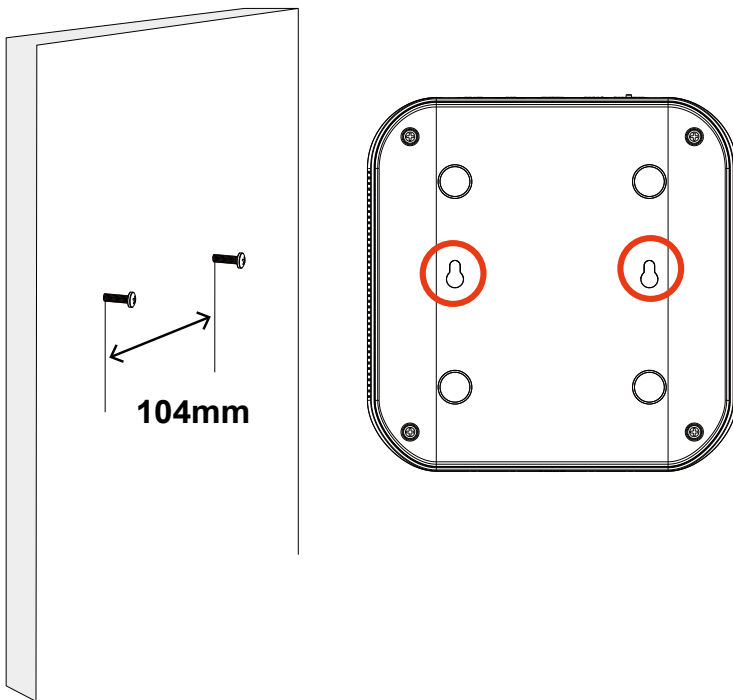

4 Interface Connections

1. Connect to a monitor using an HDMI cable.
2. Connect CAT5e or better-quality Ethernet cable to the network.
3. Connect USB devices such as mouse, keyboard, or USB thumb drive (formatted in FAT format), or UPS.
4. Connect the power adaptor to the power mains and the system.

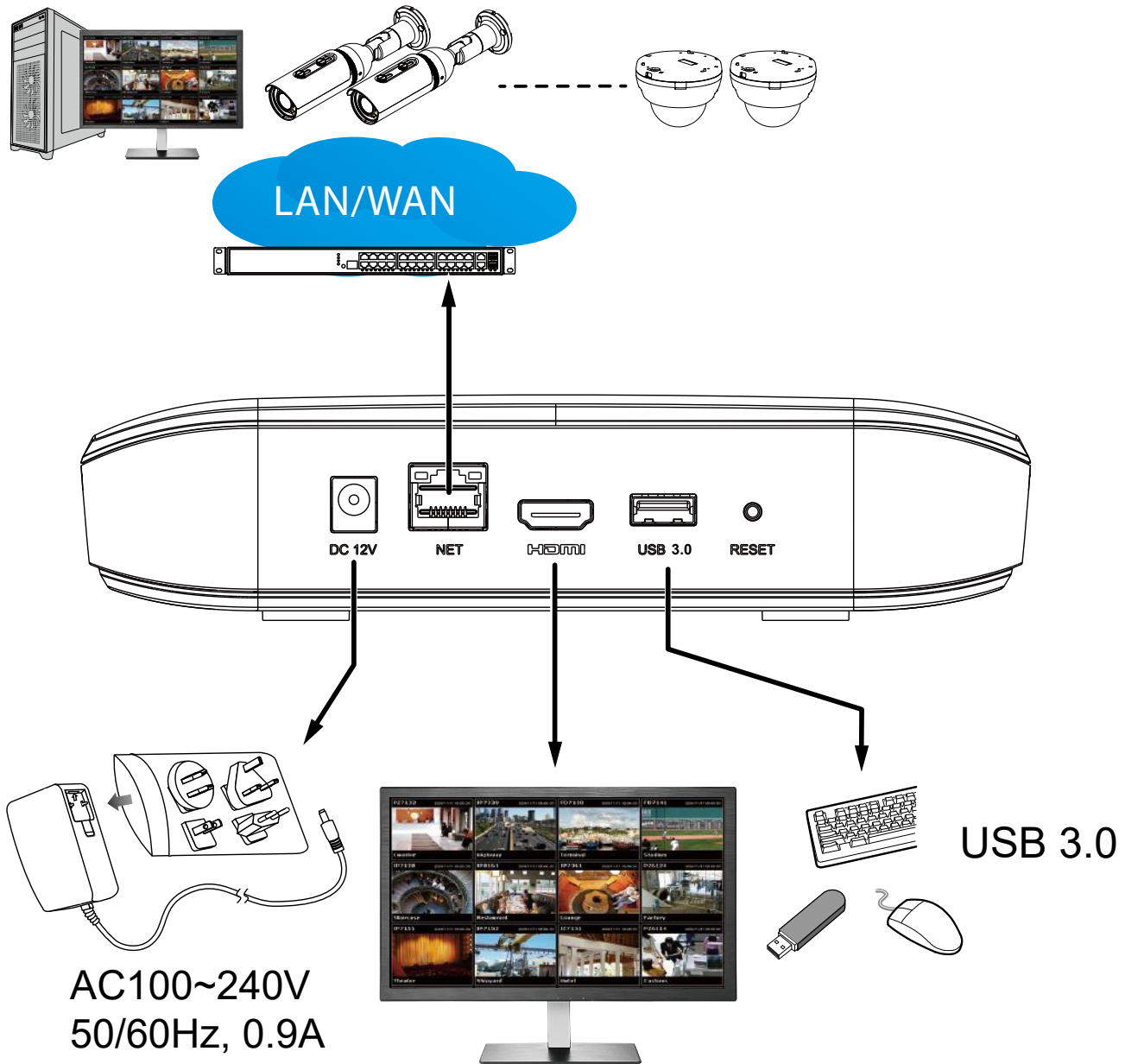

Pressing the Reset button for longer than 10 seconds will restore the factory defaults.

5 Initial Configuration - via a Local Console

A local console requires the following:

1. A monitor or TV is connected via an HDMI cable.
2. A mouse and/or a keyboard are connected to the system.
3. It is presumed that the system has not been configured yet. The Installation wizard only appears for an unconfigured machine or one that was restored to its default.

Follow the onscreen messages to complete the initial configuration:

1. When started for the first time, the system will prompt for the forceful configuration of a password. This ensures security from malicious network attack.

The applicable alpha-numeric characters are [0-9][a-z][A-Z][!][\$][%][-].[][@][^][_][~], with a max. length of 64 characters.

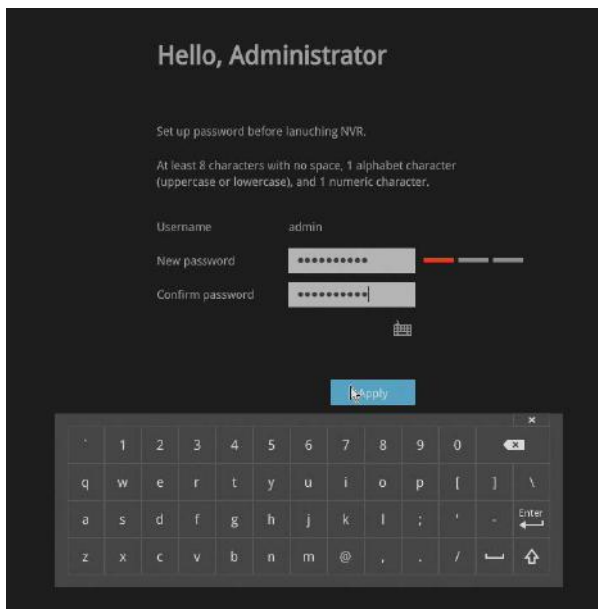

Click the **Apply** button when the new password is accepted.

2. Select the UI language, Time zone, and current date and time. Click on the **Continue** button to proceed.

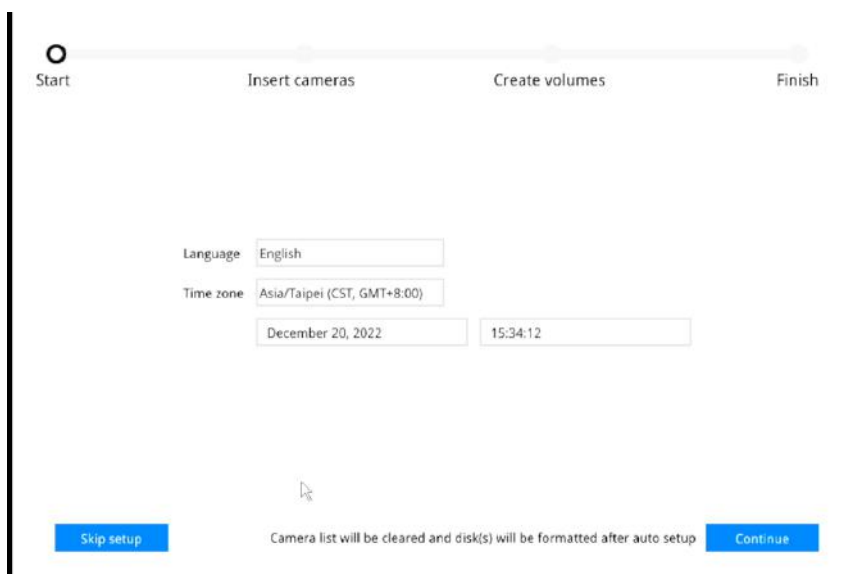

3. The system will then start to scan the local subnet for connected cameras.



4. All cameras detected on the network will be automatically listed. If necessary, deselect the cameras you want to exclude from the configuration.

Cameras properly installed in the same subnet should all be listed. If you cannot find a camera, examine its network connections or network configuration.

Unselect all	IP	MAC	Model	Port	Channel
<input type="checkbox"/>	192.168.51.159	00-02-d1-a3-d6-4e	SD9161-H-v2	80	1
<input type="checkbox"/>	192.168.51.101	00-02-d1-a4-37-28	IP9191-LPC-v2[9-50...	80	1
<input type="checkbox"/>	192.168.51.57	02-e7-68-43-c1-72	FD9391-EHTV-v2	80	1

[Skip camera insert](#)

Enter the credentials for each selected cameras on screen. Click **Finish** to proceed.

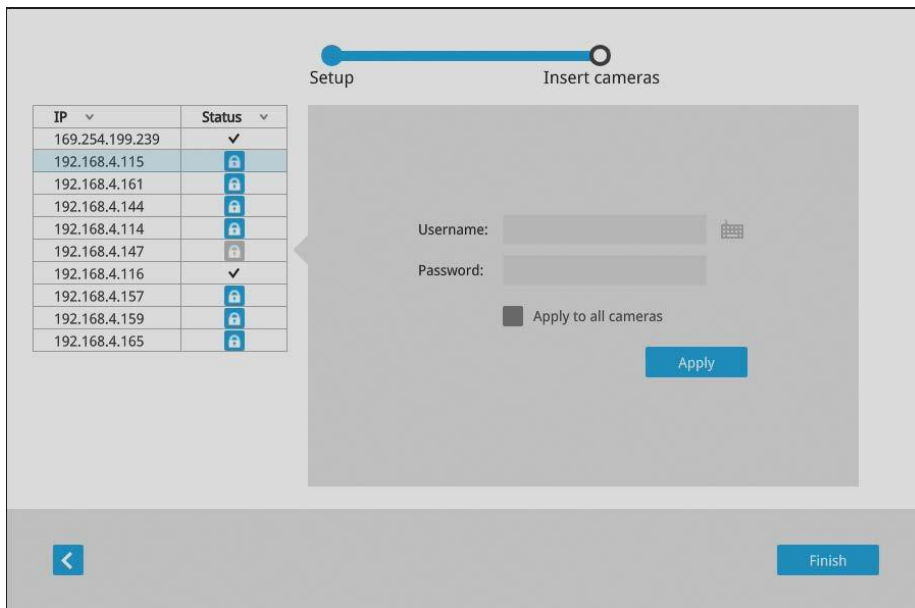

 **NOTE:**

1. The resolution and fps (frame rate per second) of stream 1 may vary depending on the specifications of different cameras.
2. Up to two clients viewing 2x 720P streams is acceptable. If more clients are simultaneously viewing more video streams, the machine can be stressed.

 **NOTE:**

Although the system supports MAC Binding, the system should be able to detect VIVOTEK's cameras within the network regardless of the presence of a DHCP server. Ideally, cameras and the Receiver should reside in the same subnet. If a camera's IP is changed for some reasons, the system should be able to detect its new IP.

6 Initial Configuration - via a Web Console (Optional)

1. Connect the power cord to start the Receiver. Wait for the system status LED to light green.
2. From a management computer, download and execute the **Shepherd** utility software. Follow the onscreen instructions to complete the installation.

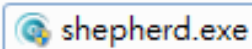

3. Start the Shepherd utility. The Shepherd utility will discover the Receiver located in the same subnet.

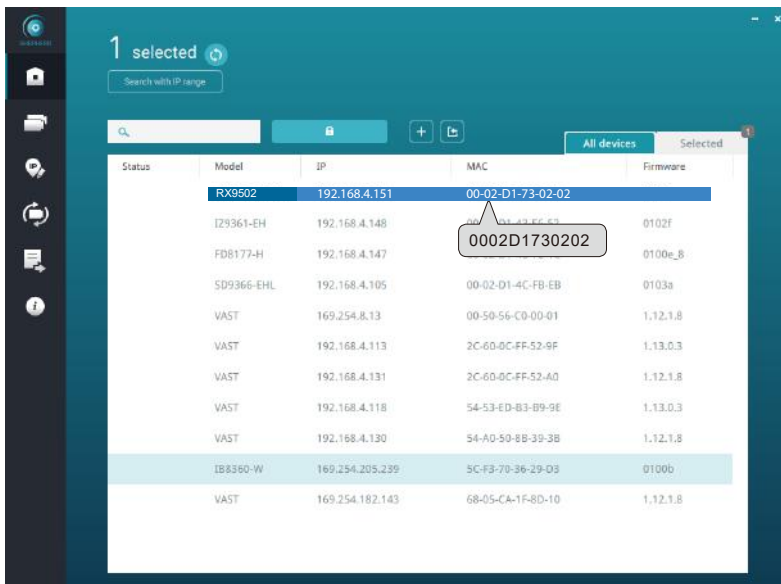

Status	Model	IP	MAC	Firmware
	RX9502	192.168.4.151	00-02-D1-73-02-02	
	I29361-EH	192.168.4.148	00-02-D1-73-02-02	0102f
	FDB177-H	192.168.4.147	0002D1730202	0100e_8
	SD9366-EHL	192.168.4.105	00-02-D1-4C-FB-EB	0103a
	VAST	169.254.8.13	00-50-56-C0-00-01	1.12.1.8
	VAST	192.168.4.113	2C-60-0C-FF-52-9F	1.13.0.3
	VAST	192.168.4.131	2C-60-0C-FF-52-A0	1.12.1.8
	VAST	192.168.4.118	54-53-ED-B3-B9-9E	1.13.0.3
	VAST	192.168.4.130	54-A0-50-8B-39-3B	1.12.1.8
	IB8360-W	169.254.205.239	5C-F3-70-36-29-D3	0100b
	VAST	169.254.182.143	68-05-CA-1F-8D-10	1.12.1.8

4. Double-click on the RX9502 entry to start a web session with the Receiver system.

5. If you have configured a user name and password on the local console, use them to log in. Ideally, the initial configuration is performed via the local console. Expand the menu on the right of the Login button. Select and click on the **Settings** button to begin your configuration.

If accessed for the first time and no password has been configured, enter **admin** and **admin** as user name and password.



6. Refer to the later discussions for the rest of the configuration procedure.

7

LED Indicators

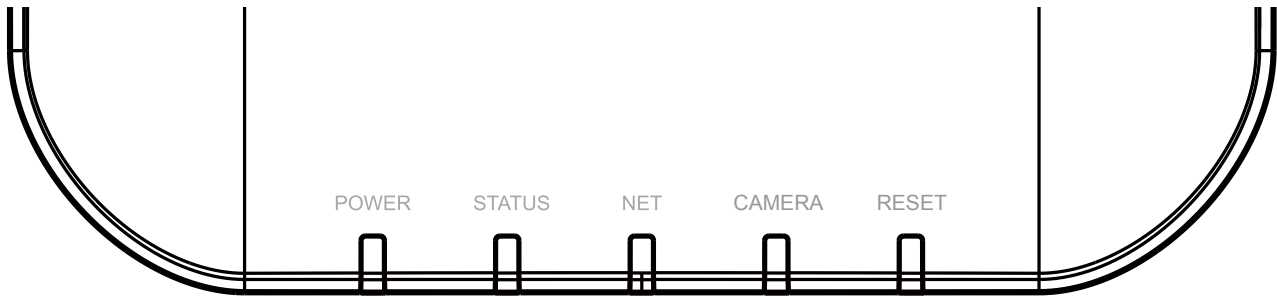

Name	Behavior	Definitions
1. Power	1 OFF	Powered down.
	2 Solid Green	Device is up and running.
2. Status	1 Green solid	System is ready.
	2 Blinking Red every 1 second	Firmware or device pack is being updated.
3. NET	1 OFF	The Ethernet port is disconnected.
	2 Orange blinking	Data is being transmitted and received.
4. Camera	1 Solid Green	All configured cameras are online.
	2 Solid Red	One or more configured cameras is disconnected.
	3 OFF	No camera is connected.
5. Reset	1 Blinking Blue	Reset or Restore to default is taking place.
	2 OFF	Normal status.

8 Power Up and Power Down

To power up and power down,

On the initial configuration:

Connect the power adapter between the system and power outlet.

After the initial connection,

Press the software power down button on the management session to power down. the system should start flushing the cached contents in system memory and gracefully shut down.

Once powered down, you need to re-connect the power cord to start the Receiver again.



Section One

Management over a Local Console

Chapter Two

Introduction to the Local Console Interface

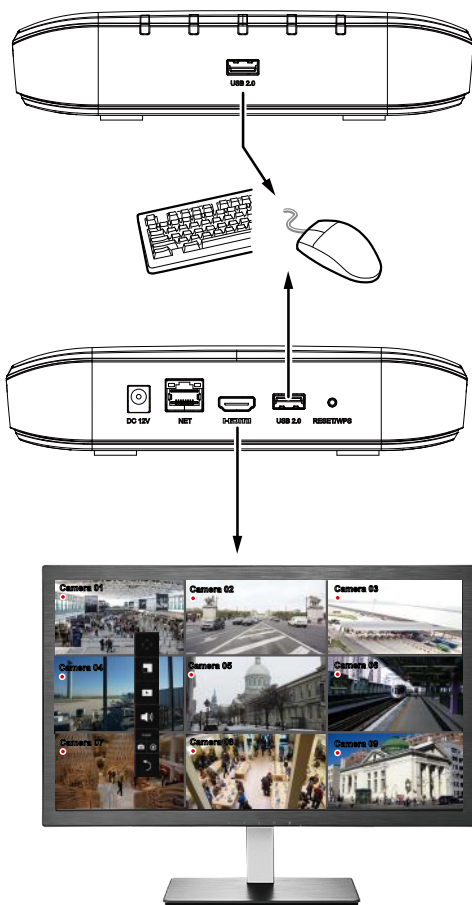

By default, a live view appears on an HDMI monitor. The interface architecture of the local console is illustrated as follows:

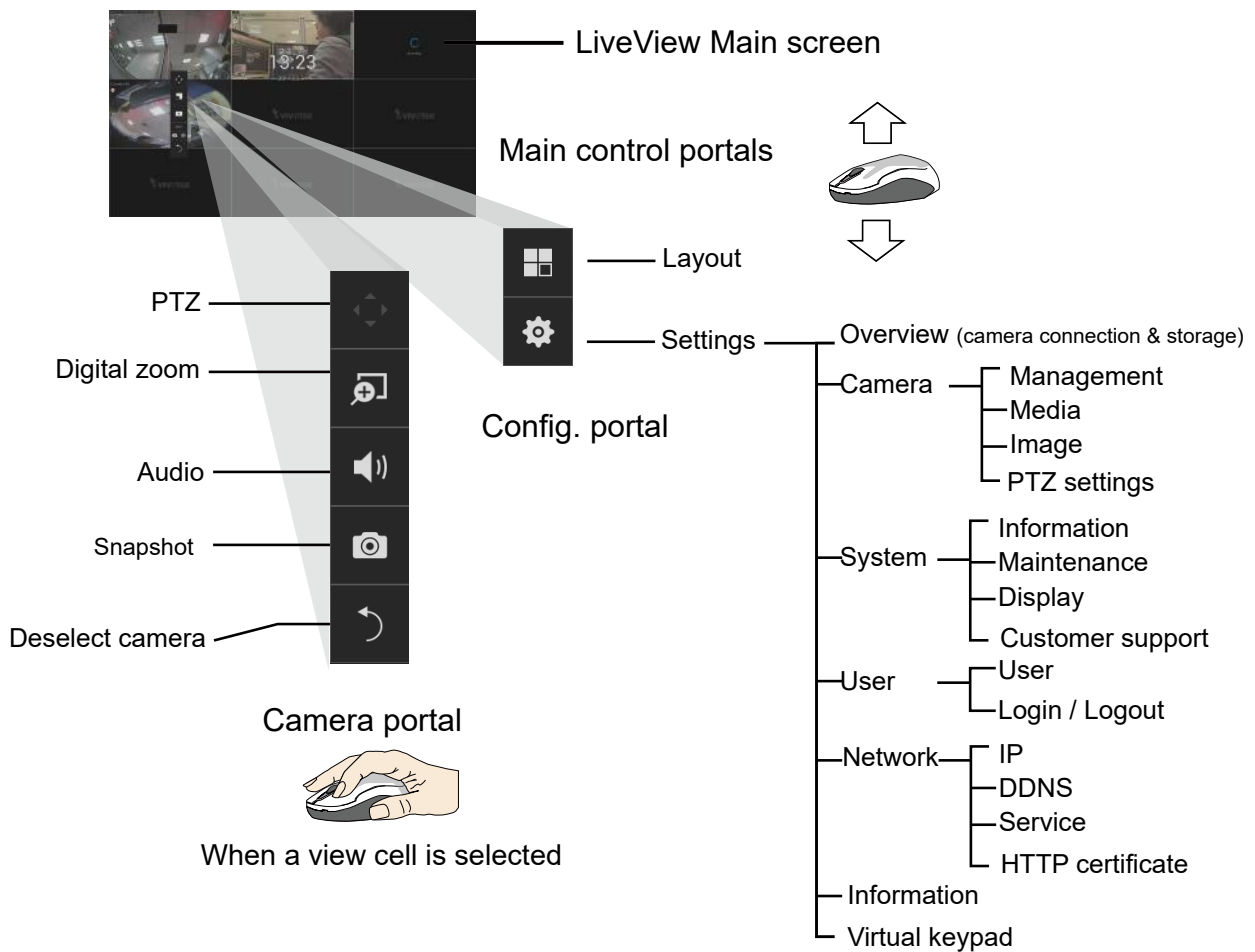

! IMPORTANT:

Due to the limitation of system resources, the fisheye dewarp (1R & 1P modes) can only take place on one view cell, for one fisheye camera.

2-1. How to Begin

1. How to access the Configuration Portal?

Make sure a mouse is attached to your Receiver. Move your mouse cursor, and the Configuration Portal will appear on screen. For all the configurable options available through this portal, please refer to Chapter 3 on page 34.

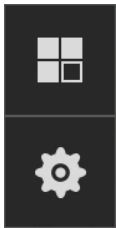

You can also hide these portal toolbar. Right-click on the LiveView screen to display the option.

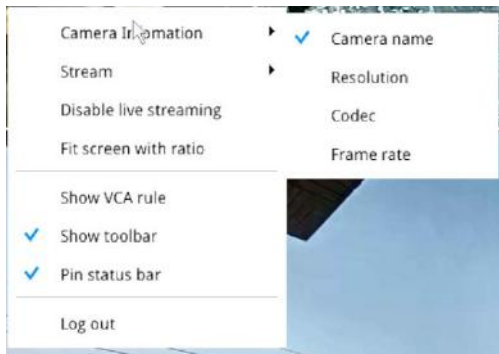

2. How to access the Camera Portal?

Single click to select a view cell, the Camera Portal will appear. The system automatically detects the characteristics of an individual camera when you select a view cell.

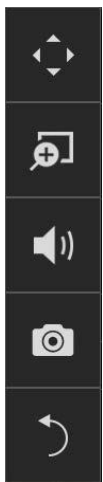

This portal appears with a camera that supports mechanical PTZ.

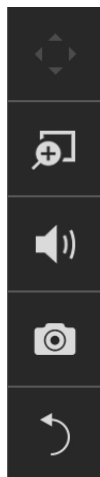

This portal appears with a camera that does not support mechanical PTZ.

Tips:

Here are some operation steps using the tool bar:

1. Single-click to select a view cell and bring out the tool bar.
2. Double-click to expand a view cell to the full view.
3. Double-click again to shrink the view cell to the original size.

PTZ control panel for ordinary PTZ type

PTZ control panel for joystick type PTZ

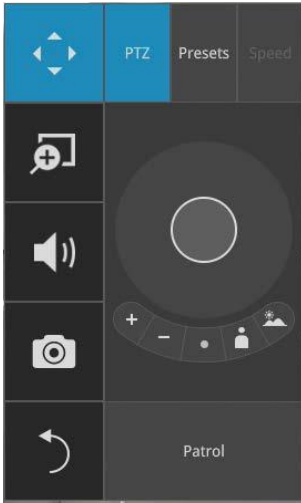

5. Why live view is unavailable?

The default live view receives a camera's stream #2. If a camera's stream #2 is configured using MPEG-4 as the video codec, the following message will prompt.

You can use the Shepherd utility to locate the camera and open a web console with the camera. Go to the **Configuration > Media > Video** window to configure the video codec of stream #2 into H.264 or H.265.

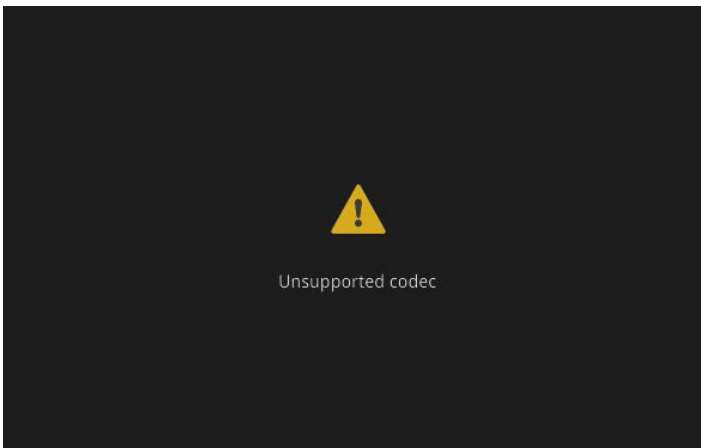



Media > Video

System

Media

Image

Video

Audio

Media profiles

Network

Security

PTZ

Event

Applications

Recording

Storage

Mode Stream

Video settings for stream 1

H.265

Resolution: 1920x1080

Maximum frame rate: 30 fps

Intra frame period: 1 S

Smart stream III

Dynamic intra frame period (Help)

Smart FPS

Smart codec:

Mode: Auto tracking

Quality priority: (Help)

Bit rate control

Constrained bit rate:

Fixed quality:

Quality: Good

Maximum bit rate: 8 Mbps

H.264

MJPEG

Video settings for stream 2

Video settings for stream 3

Save

Version: 1.2203.35.01b

6. How do I move to another layout page?

Move your cursor to the right hand side of your screen. The page turner buttons will appear as shown below.

For example, if you have 8 cameras placed on 2 2x2 layout pages, use these buttons to visit different pages.

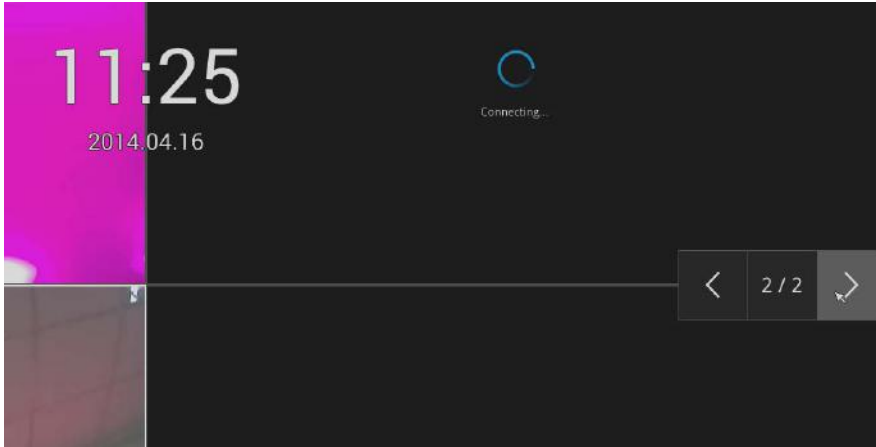

7. Why the onscreen tool bars disappear after some time?

The system comes with idle modes. Below are the applicable conditions:

1. **Live view**: if no management activities occur for 5 seconds, the tool bars disappear from screen. When in the idle mode, mouse cursor and tool bars will disappear. Moving the mouse cursor will re-activate the screen.
2. **Settings** page: If left unattended for 10 minutes, system will automatically log out. The system will prompt for user credentials if a user tries to access the Settings page again.

2-2. Operation on a Camera View Cell

The following apply when a camera view cell is selected.

2-2-1. PTZ Panel



Once you selected a camera, click on the PTZ button on a camera portal.

The PTZ panel will prompt. Below are the description of its functions:

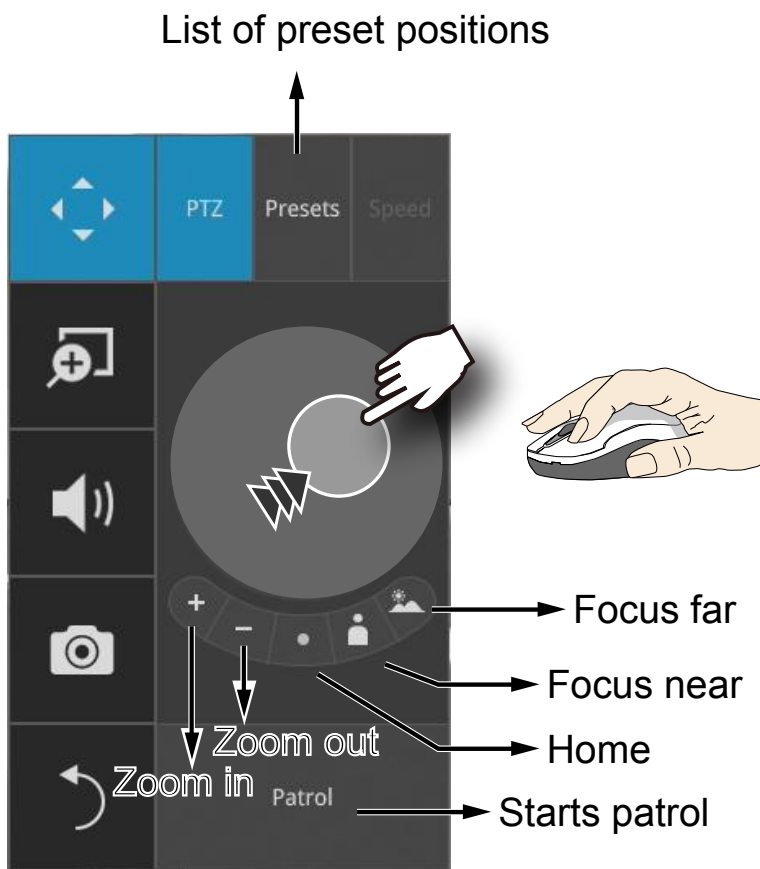

1. **PTZ** control: Click and drag the nudget in the center towards the direction you wish to move to.
2. **Focus**: Click on the Focus near and Focus far buttons to adjust camera focus.
3. **Home**: Click to move the camera lens towards the default home position.
4. **Zoom**: Use the Zoom in and Zoom out buttons to adjust the camera's zoom ratio.
5. **Presets**: If you configured preset positions, a list of preset positions will appear.
6. **Patrol**: If you configured preset positions into a patrolling tour, click on this button and the camera will proceed with patrolling through preset points.

Note that on a speed dome camera, the farther you pull the nugget away from the center, the faster the lens moves. This works like speed control.



This portal appears with a fisheye camera. The PiP and PTZ buttons will then be disabled for a fisheye camera.

 **IMPORTANT:**

Due to the limitation of system resources, the fisheye dewarp (1R & 1P) can only take place on one view cell, for one fisheye camera.

Joystick support



The joystick related operations are listed below:

1. **Pan:** Continuous move is supported. (joystick X-axis movement)
2. **Tilt:** Continuous move is supported. (joystick Y-axis movement)
3. **Zoom:** Continuous move is supported. To zoom in, move joystick Z-axis clockwise. To zoom out, move joystick Z-axis counter-clockwise.

The Receiver supports VIVOTEK's IPD-USB(3-axis, 12 buttons), AJ-001(3-axis, 8 buttons), and AJ-002 (3-axis , 29 buttons) joysticks.

The default button functionality are described below:

Button	Function	Note	Live	Setting	Playback
1	Pan		V	V	-
2	Patrol	Supports the first patrol	V	V	-
3	Stop		V	V	-
4	Home		V	V	-
5	Focus Near		V	V	-
6	Focus Far		V	V	-
7	Snapshot		V		V
8	Preset		V	V (PTZ setting/ Motion only)	-
9 ~ 17,19	Number 0~9		V	V (PTZ setting/ Motion only)	V
18	ESC		V	V	V
20	Enter		V	V (PTZ setting/ Motion only)	
21	Full screen	When a view cell is selected, also applies in the Playback. Press the second time to return to previous state.	V	-	V

22	Manual Recording	Press once to start manual recording. Press the second time to stop.	V	-	-
23	Change Layout	Consecutively changes layout	V	-	V
24	Rewind		-	-	V
25	Pause		-	-	V
26	Play		-	-	V
27	Speed Up		-	-	V
28	Slow down		-	-	V
29	Change focus view	In live view/playback layout, will move from top left to lower right, from view cell to view cell.	V	-	V

Multi-key Combinations

Button	Function	NOTE	Live	Setting	Playback
Number+ Enter	Turns a channel into full view (AJ002 only)	None responsive if unconfigured channel number is entered; e.g., 9+Enter on an 8-CH Receiver.	V	-	V
Preset+ Number + Enter	On a PTZ camera view cell, moves to a preset position (AJ002 only)	None responsive if unconfigured position number is entered	V	V (PTZ setting/ Motion only)	-
Preset + Number	On a PTZ camera view cell, moves to a preset position (AJ001)	None responsive if unconfigured position number is entered	V	V (PTZ setting/ Motion only)	-

2-2-2. Digital Zoom Panel



Digital zoom is a function that allows an operator to zoom in or zoom out on a live video.

When activated, a **Global view** window will appear at the lower right of the view cell as shown below. You can display only a portion of the complete video frame as an area of your interest. Using a click and drag on the **ROI** window, you can instantly move to other areas within the video frame. Use the zoom ratio pull bar at the bottom to change the zoom ratio. You may also move the ROI around by clicks and drags.

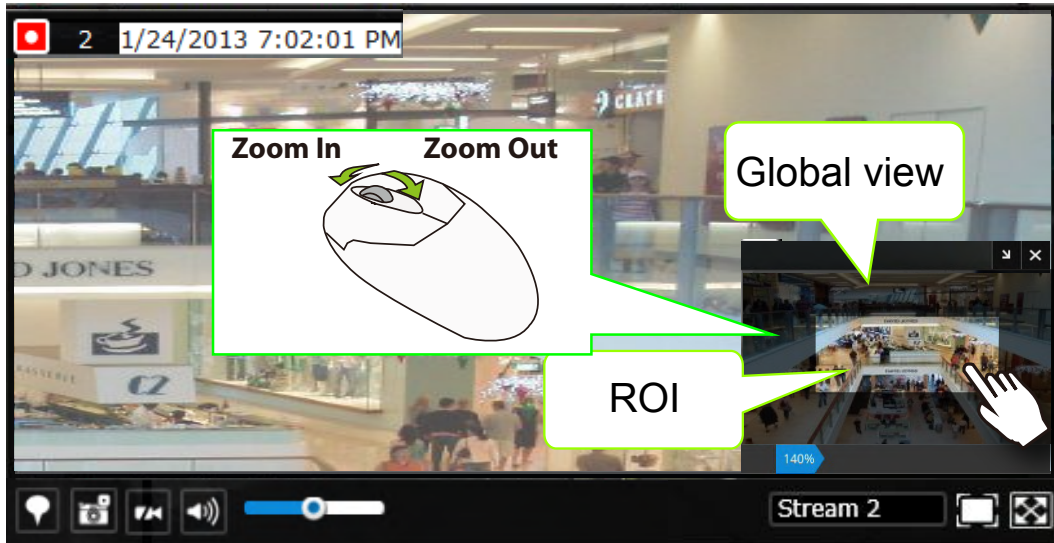

Note that not every camera supports the PiP function.

2-2-3. Others

1. **Snapshot** : is used to take a snapshot from the camera currently selected. Note that this function only saves the snapshot (in JPEG) to a USB thumb drive.

 **IMPPOINTANT:**

The USB thumb drive has to be one that is formatted in FAT format.

2. **Return** button : Click to return to the LiveView window.

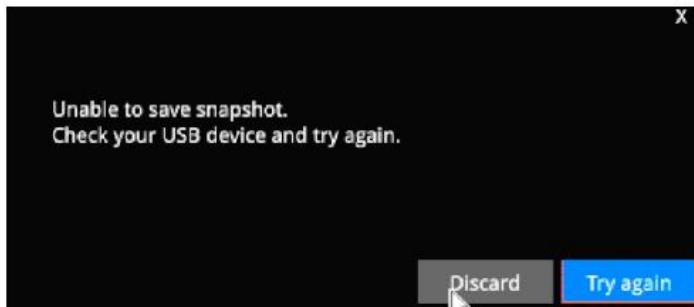

2-2-4. Right-click Commands

Left-click to select a camera. Right-click to display the selection menu.

1. **Camera information:** Click to display camera name, resolution, codec, or frame rate on the view cell. The information will display on the upper left corner of a view cell.
2. **Stream:** Default is enabled. The Auto adaptive stream automatically polls a video stream of a smaller resolution (changing the resolution of stream #2) in order to reduce the streaming efforts. For example, when a view cell is placed in a 3x3 monitor layout, it may not be necessary to stream the video in its full resolution. In a full view, the system displays a video in its full resolution. Due to the size of view cells on your monitor, when in a multi-cell layout, the system automatically polls the camera for a smaller resolution stream.

The Auto adaptive stream feature can be disabled if you prefer consistent display resolution.

3. **Disable live streaming:** Use this to disable the current live streaming.
4. **Fit screen with ratio:** The Receiver server automatically optimizes the display camera view cells. However, you can still select this option to display the camera's original aspect ratio: for example, the original video feed can be 4:3. Without the fit screen, every camera's image will be expanded to fill the view cell.
5. **Show VCA rule:** If you have configured the video analytics rules on the camera, enable this to display the VCA rules detection lines and zones.
6. **Show tool bar:** You can hide the tool bars by deselecting this option.
7. **Pin status bar:** You can hide the time stamp bars by deselecting this option.
8. **Log in:** Log in to enable system configuration.

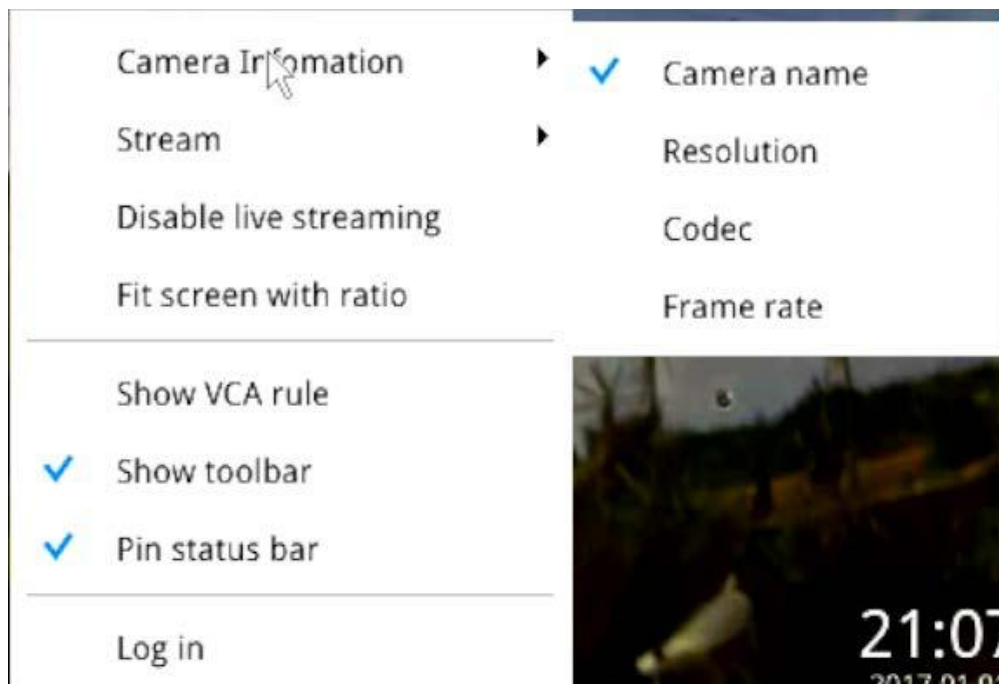

Chapter Three

Configuration Using the Local Console

The Main Control Portal

3-1. Layout



Move your mouse cursor across the screen to display the portal.

The first functional button is Layout. You can select the 1x1, 2x2, 3x3, 4x4, 1M+5, 1M+12, 1M+31, 1P+3, 1P+6, 2P+3, 3V layout as the screen display.

If you select the single view layout, the rotation button  will appear.

Click the rotation button below to let the system swap the display of different cameras by every 10 seconds. The rotation speed is configurable via Settings > System > Display.

3-2. Settings

3-2-1. Settings - Overview



Click the **Settings** button to start the camera and system settings window. A confirm box will prompt. Enter User name and Password to proceed.

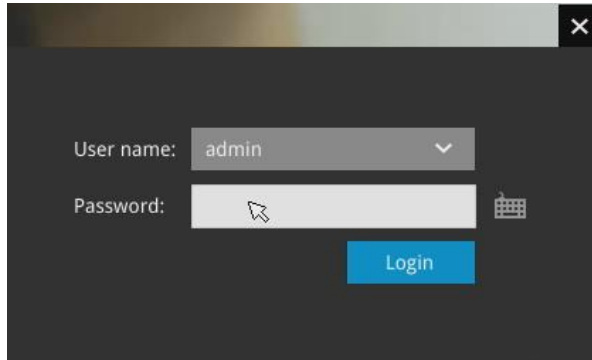

The system will default to the overview page displaying the camera connection statuses. An empty position will be left in blank, and a disconnected camera will be indicated as



The **Reboot**, and **Power-down** buttons are also available on this page.

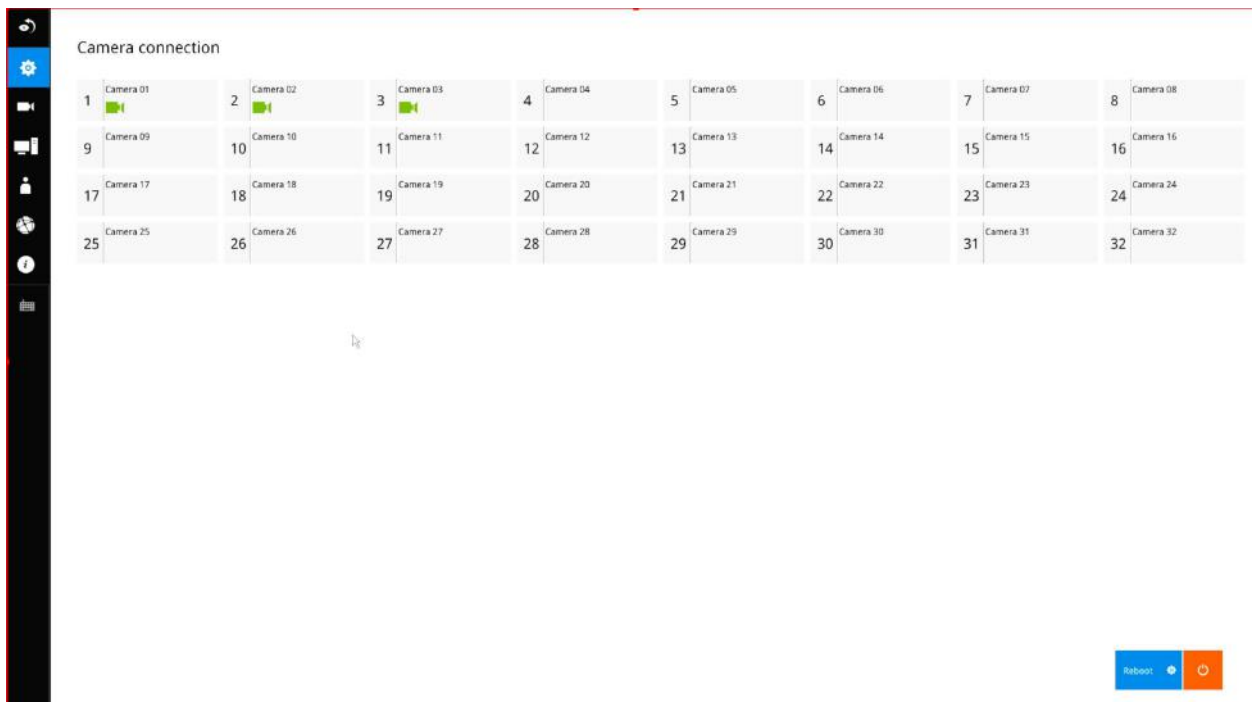

The Camera menu provides access to **Management**, **Media**, **Image**, **Motion detection**, and **PTZ settings** pages.

3-2-2. Settings - Camera - Management

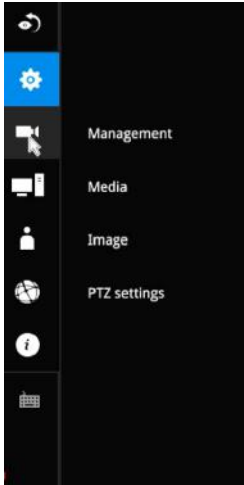

On the camera Management page, you can configure the following:

1. Recruit or disband cameras.
2. Assign User name and Password, or apply the credentials to all cameras in your configuration.
3. Change the Network settings.
4. Change the cameras' positions on the layout screen.

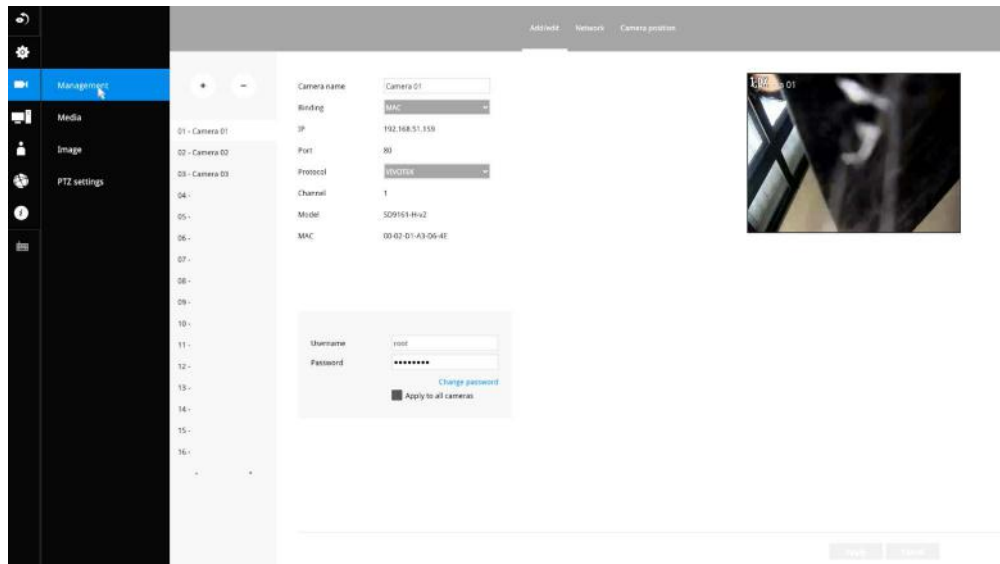

To recruit cameras:

1. Click on the Add  button. A list of cameras in the same subnet will appear.

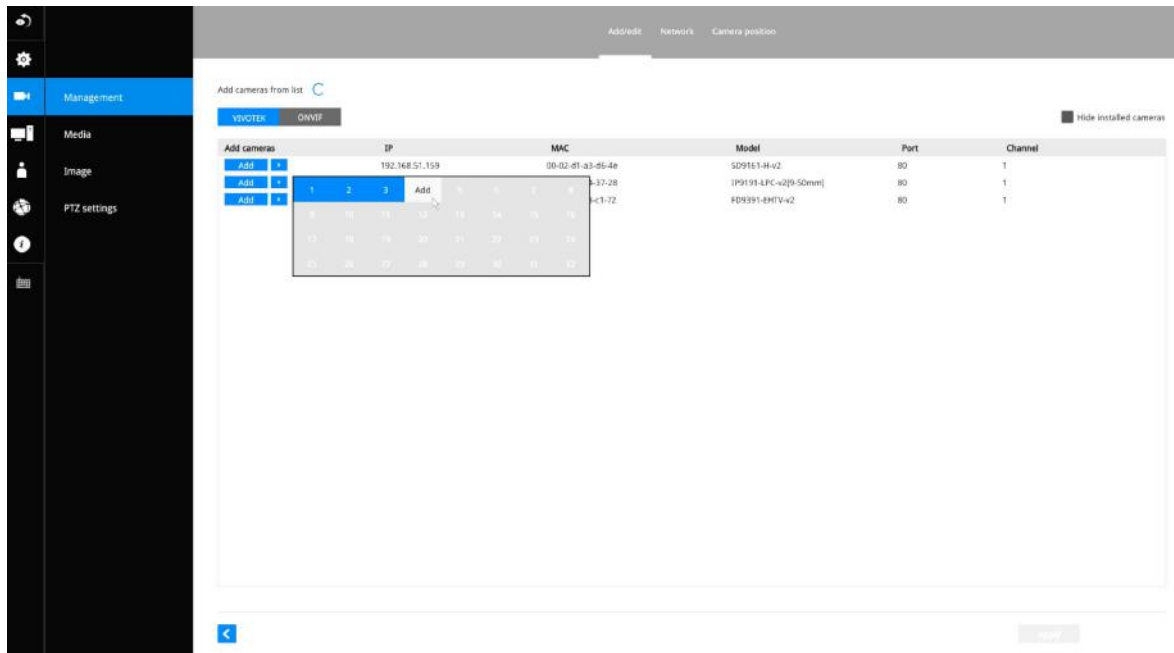

2. Click the **Add** button, the camera will be placed at an unoccupied position. You may also expand the menu on the side of the Add button to select a position number.
3. When a camera is added, it should appear on the graphical placement below.
4. Click the Apply button after you added cameras.
5. You may click the page back button  to return to the previous window.

To disband cameras:

1. Click on the **Remove**  button. A list of cameras in your configuration will appear.

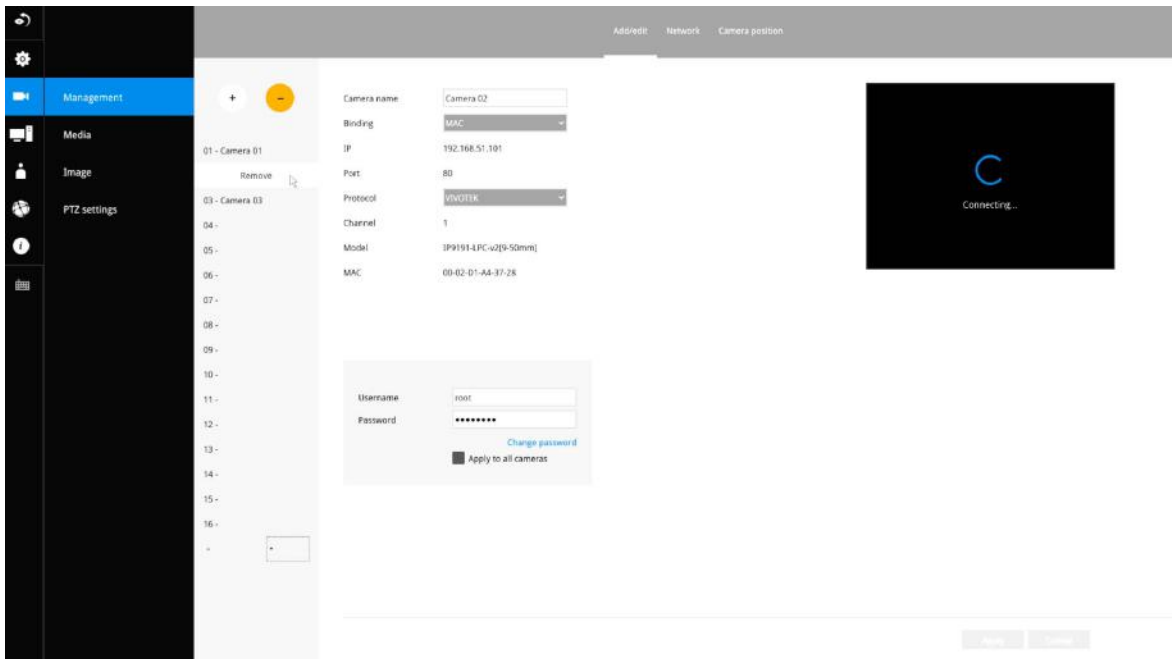

2. The **Remove** button will turn yellow . Mouse over to the camera you want to remove, and its entry will display the **Remove** message.
3. Click on the Remove message. The camera should then disappear from the camera list. The live stream coming from that camera will also be discontinued.

For legacy cameras, the receiver supports RTSP connections since firmware release revision 2.6.x.

To manually add a legacy camera,

1. Select an empty camera entry,
2. Click the Add button,
3. Select RTSP as the protocol.
4. The original rtsp address is: `rtsp://<ip address>:<rtsp port>/<access name>` for stream 1 to 3>. For example, when the access name for stream 1 is set to live.sdp: `rtsp://192.168.5.151:554/live.sdp`.

However, you only need to enter IP address and "live.sdp" in the URL field. The system automatically fills in the other parameters.

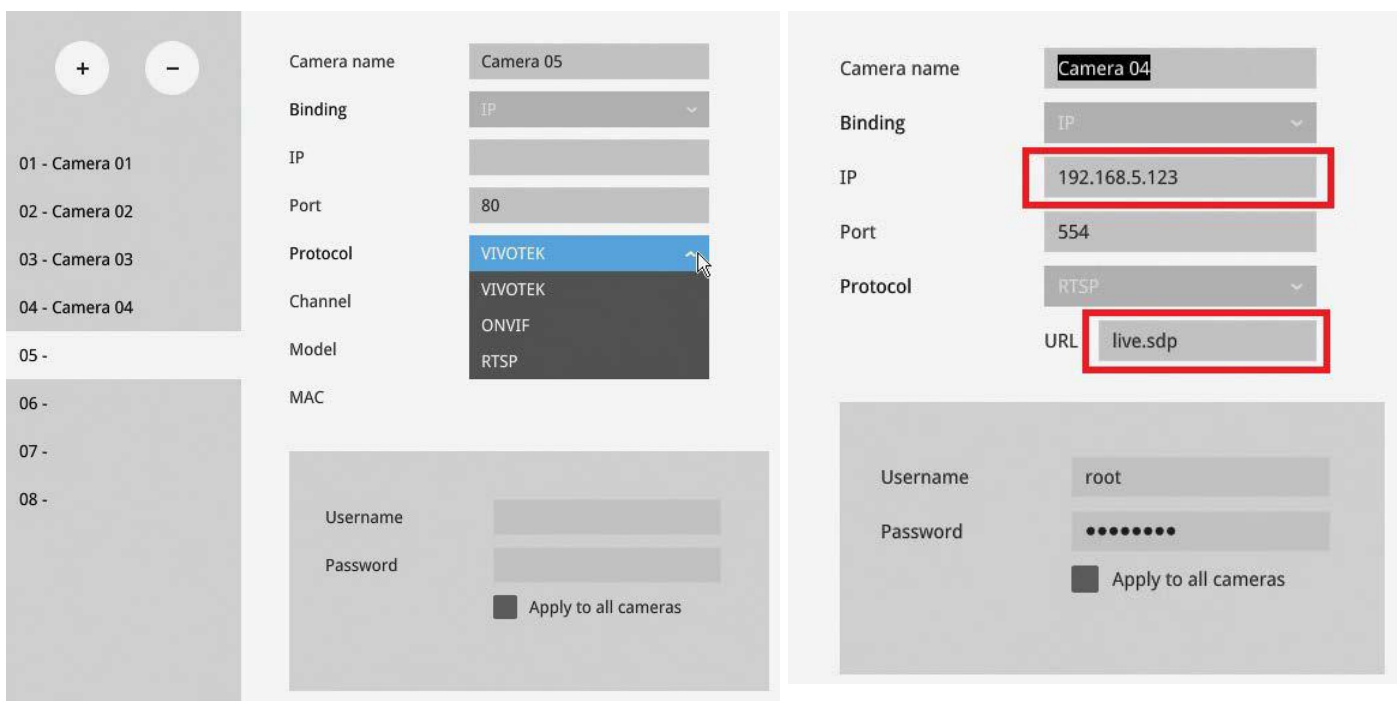

Note the following when using RTSP connections:

1. RTSP cameras do not support event recording in the Schedule settings.
2. RTSP cameras do not support FTP, Camera DO, and PTZ as the Alarm action.
3. RTSP cameras do not support camera's related settings such as Network, Video, Audio, and Display configurations.
4. RTSP cameras will be indicated by an RTSP tag in the device list.
5. RTSP cameras do not support Motion detection configuration.
6. RTSP cameras can not be selected as an alarm trigger.

In Media > Stream management page, the related Video, Audio, and stream configuration for RTSP cameras can not be edited. The RSTP cameras will be tagged.

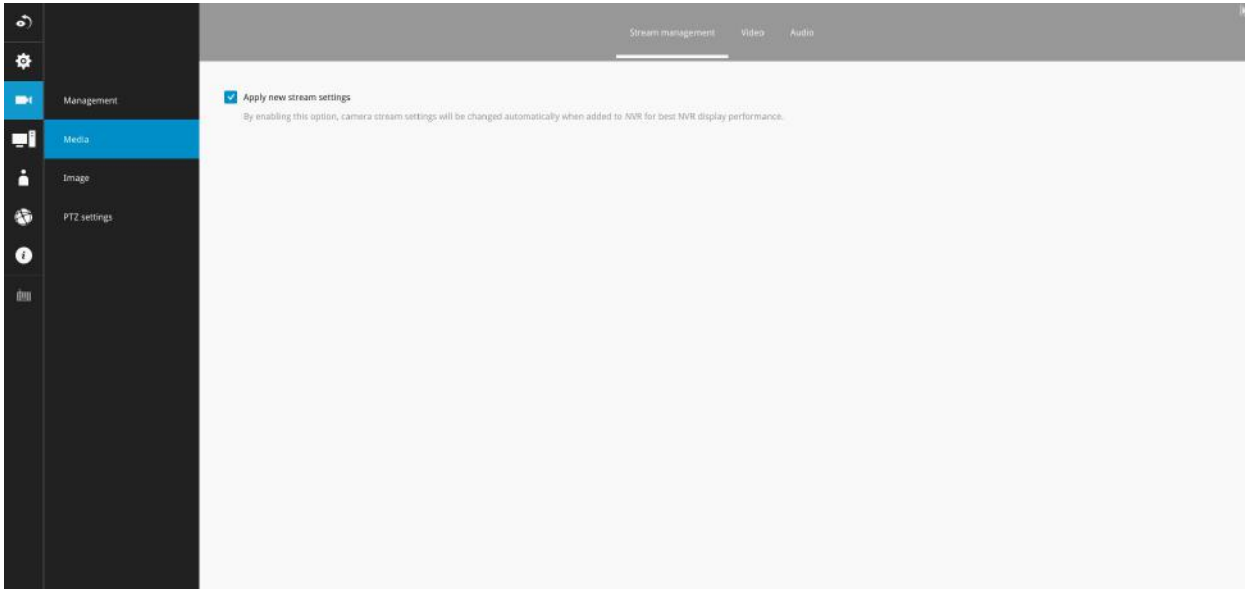

Network

On the Network tabbed window, you can configure the network type, IP address, and the connection ports for video streaming.

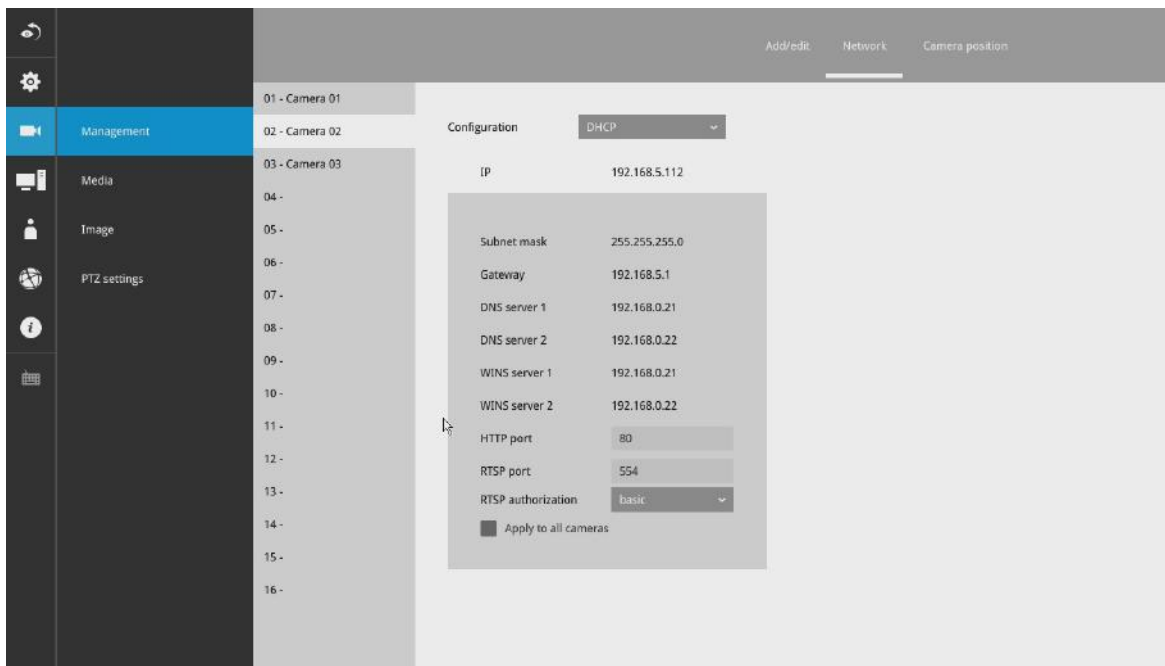

You can select DHCP as the method for cameras to acquire IP addresses, or you can manually configure static IPs for a single or all cameras. Using static IPs is recommended. Although the Receiver can remember the MAC addresses of cameras, if IPs are changed under the DHCP configuration, your Receiver may still fail to connect the cameras. Please consult your network administrator for details about network settings.

It is usually not necessary to change port numbers for the HTTP and RTSP ports unless there is a conflict in your network environment.

Camera position

To change a camera's position on the Liveview layout, click and drag a camera to an unpopulated position. Note that you cannot swap the positions of two cameras by dragging a camera onto a position already populated by the other. Also, the camera index number on the management list is not affected by the change of positions.

Click the **Apply** button for the configuration change to take effect. The position screen displays the current layout on the Liveview screen.

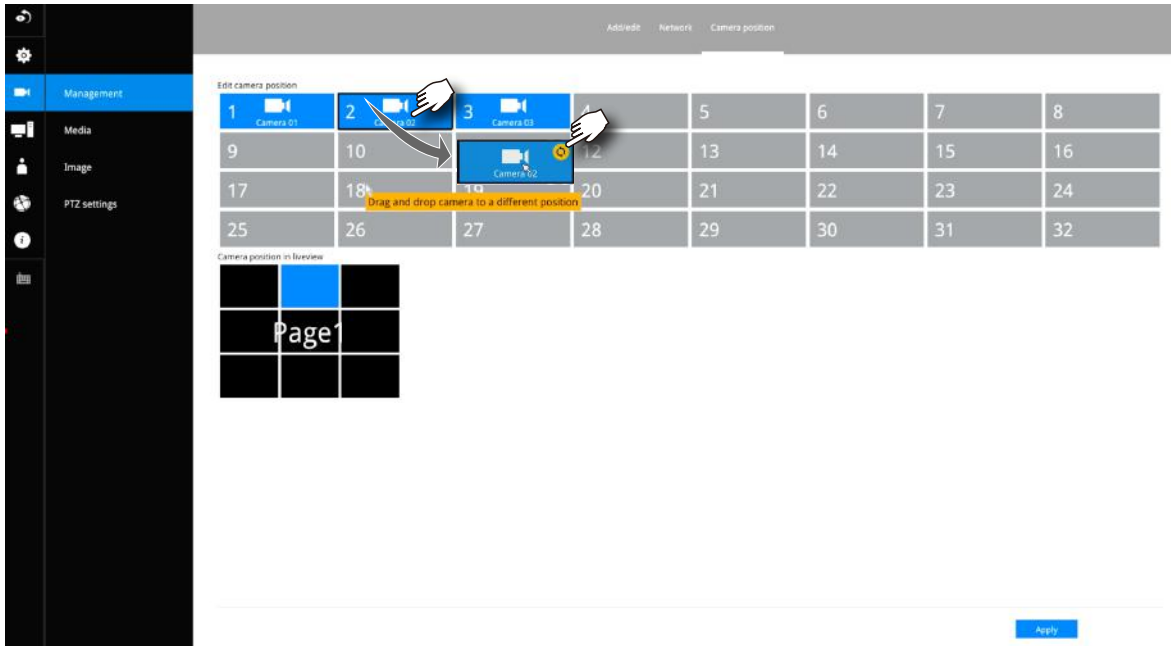

3-3-1. Settings–Camera–Media

The receiver automatically changes camera stream settings when cameras are added.

If users want to manually configure camera stream setting, they can disable this function. The default for the automatic configuration is,

- Main stream: H.265 1080p
- Sub stream: H.264 360p

The Main stream is set for higher video resolution & Network bandwidth use. The Sub stream requires lower video resolution & Network bandwidth. Users can not associate individual camera stream with either the Main or Sub stream.

- Main stream: the 1st stream of camera with H.265/1080p /4Mbps/max frame rate.
- Sub stream: the 2nd stream of camera with H.264/360P/1Mbps/max frame rate
- If the connected camera does not support the values described above, the Receiver will take the value close to the specifications (resolution/ bitrate)
- The Main stream is applied with 2x2 or other layout of a larger view cell.
- The Sub stream is applied with 3x3 or other layouts of a smaller view cell.

On a local console, the P (Panoramic or M (Middle) view cell will display the Main stream.

On a web console, the Main stream is displayed on a 1x1 layout. The Sub stream is displayed on other layouts.

For Playback:

Only the Main stream is selected for live display. The exported clip file should be the same as selected as the stream type. The Main stream will be the default.

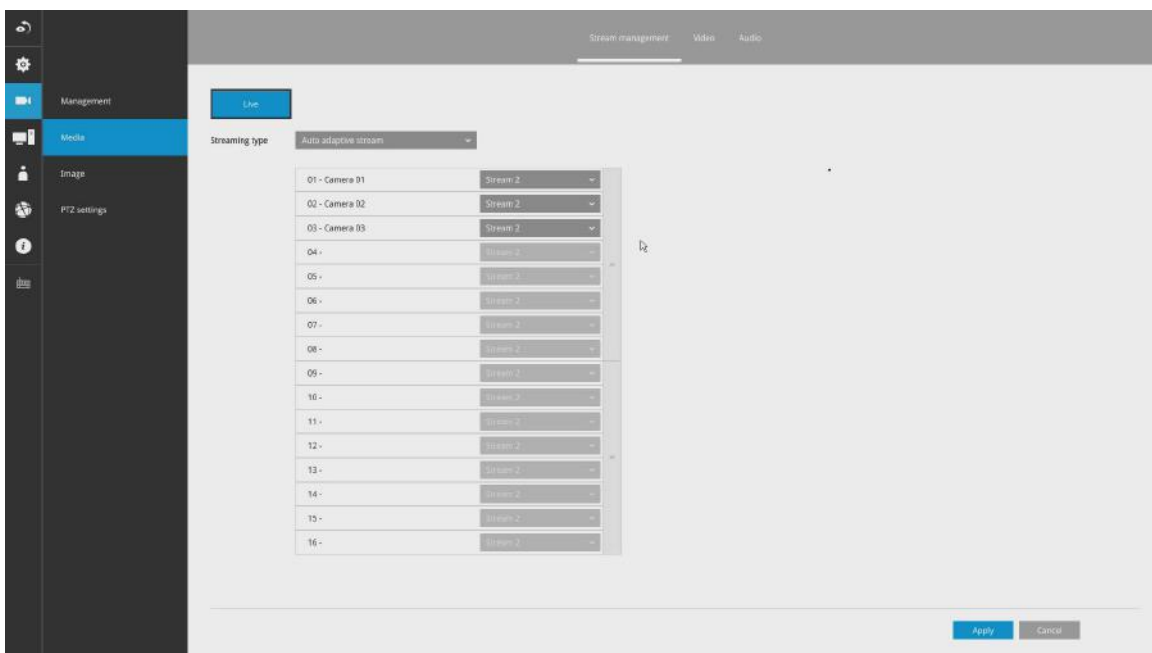

The receiver adaptively selects to display a video stream of a different resolution when it is displaying on a smaller view cell or a full screen.

Video

The Video window allows you to configure all video streams (the no. of stream available can be different for different models). You can configure the following:

1. Codec: video compression codec in H.264, MPEG-4, or MJPEG. Note that MPEG-4 is not supported for Liveview.
2. Frame size: video resolution. Note that due to the limited CPU resources, you may not be able to change the resolution to a very high value, e.g., 5MP in the 1920x1920 resolution.
3. Maximum frame rate: the highest frame rate.
4. Intra frame period: How often an I-frame will be inserted into the video stream.
5. Smart Stream II: Some newer camera models come with Smart Stream features. Please refer to the next page for detailed information.
6. Video quality: You may either select Constant bit rate or Fixed Quality as the defining rules for video transmission:

Constant bit rate	Places a packet size threshold on video frames; This guarantees the frame rate per second performance, yet image quality can be compromised if bandwidth is not sufficient in your network environment.
Fixed Quality	Guaranteed video quality, and to ensure image quality, some frames may be dropped when bandwidth is not sufficient.

When done with the configuration, click the **Apply** button.

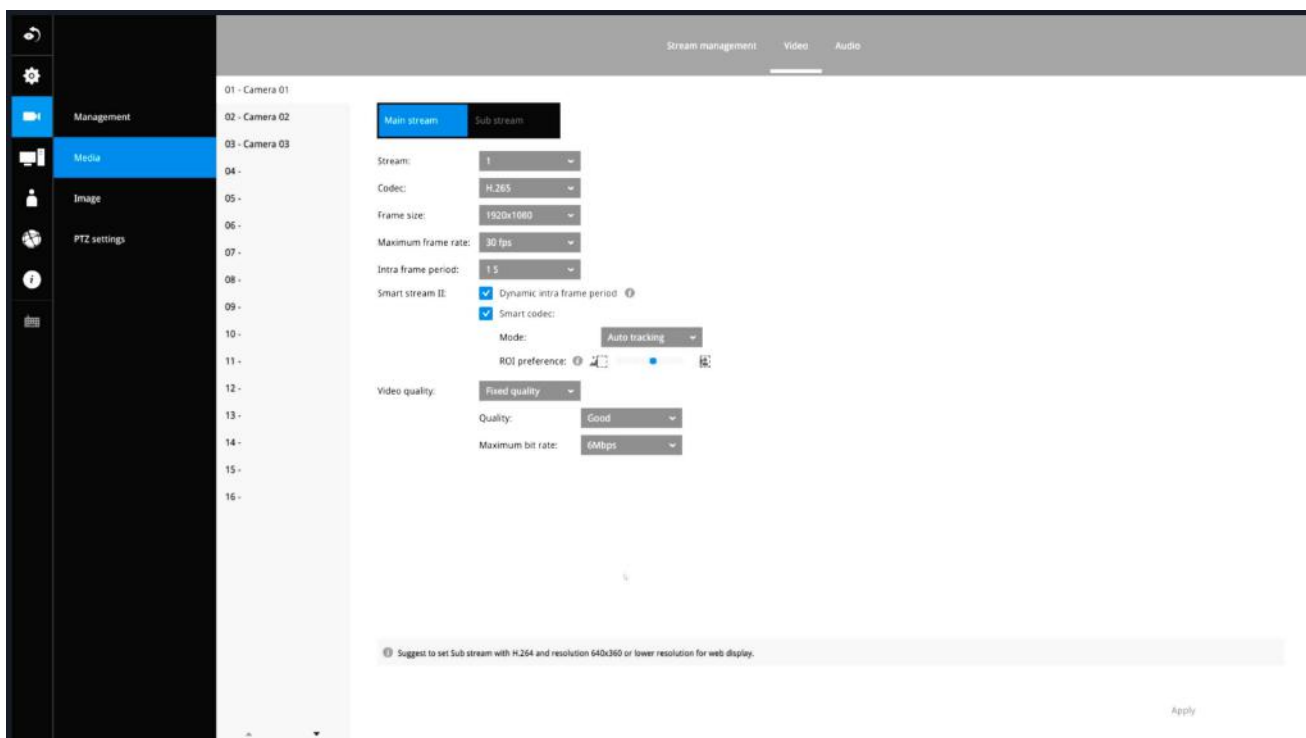

■ Dynamic Intra frame period

High quality motion codecs, such as H.265, utilize the redundancies between video frames to deliver video streams at a balance of quality and bit rate.

The encoding parameters are summarized and illustrated below. The **I-frames** are completely self-referential and they are largest in size. The **P-frames** are predicted frames. The encoder refers to the previous I- or P-frames for redundant image information.

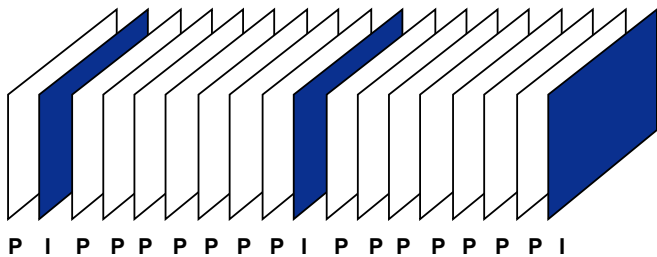

H.264/265 Frame Types

By dynamically prolonging the intervals for I-frames insertion to up to 10 seconds, the bit rates required for streaming a video can be tremendously reduced. When streaming a video of a static scene, the Dynamic Intra frame feature can save up to 53% of bandwidth. The amount of bandwidth thus saved is also determined by the activities in the field of view. If activities occur in the scene, firmware automatically shortens the I-frame insertion intervals in order to maintain image quality. In the low light or night conditions, the sizes of P-frames tend to be enlarged due to the noises, and hence the bandwidth saving effect is also reduced.

Streaming a typical 2MP scene normally requires 3~4Mb/s of bandwidth. With the Dynamic Intra frame function, the bandwidth for streaming a medium-traffic scene can be reduced to 2~3Mb/s, and during the no-traffic period of time, down to 500kb/s.

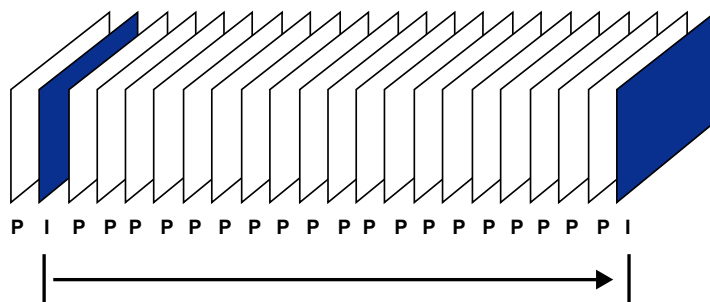

Static scene

Dynamic Intra Frame w/
static scenes

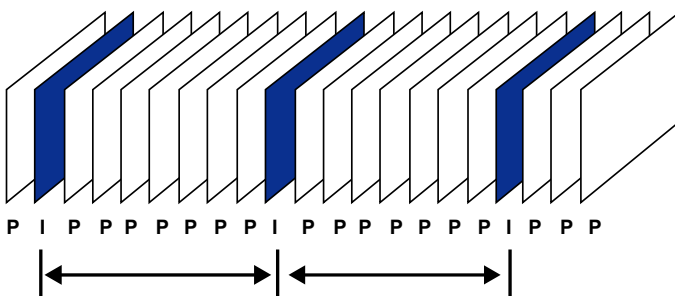

Activities

Dynamic Intra Frame w/
activities in scenes

- **Smart codec** effectively reduces the quality of the whole or the non-interested areas on a screen and therefore reduces the bandwidth consumed.

You can manually specify the video quality for the foreground and the background areas.

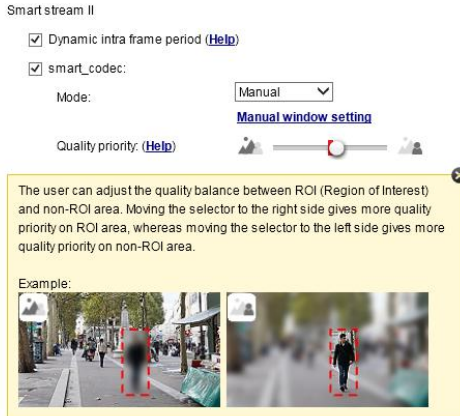

Slide bar to the right - higher quality in the ROI areas
 Slide bar to the left - higher quality in the non-ROI areas.

Select an operation mode if Smart codec is preferred.

- **Auto tracking:** The Auto mode configures the whole screen into the non-interested area. The video quality of part of the screen returns to normal when one or more objects move in that area. The remainder of the screen where there are no moving objects (no pixel changes) will still be transmitted in low-quality format.
- **Manual:** The Manual mode allows you to configure 3 ROI windows (Region of Interest, with Foreground quality) on the screen. Areas not included in any ROI windows will be considered as the non-interested areas. The details in the ROI areas will be transmitted in a higher-quality video format.

As illustrated below, the upper screen may contain little details of your interest, while the sidewalk on the lower screen is included in an ROI window.

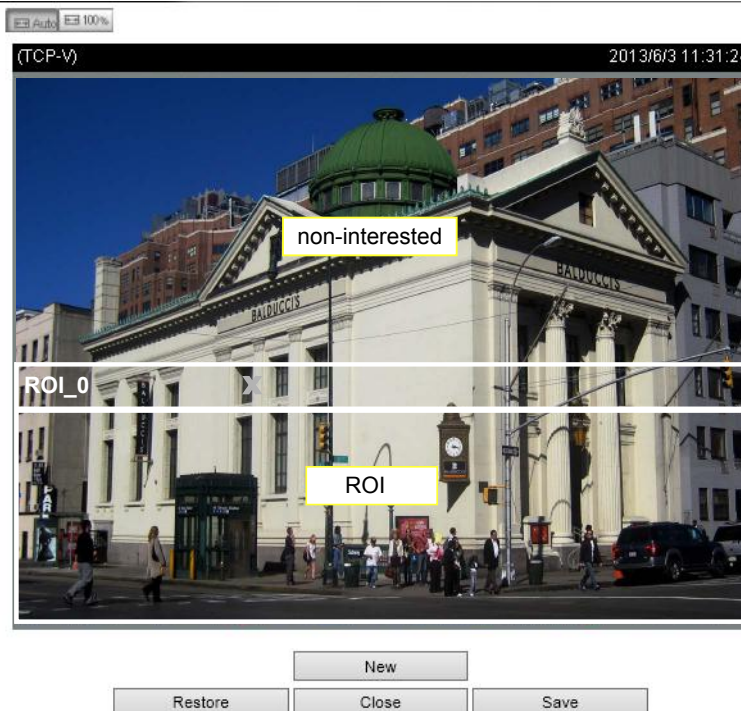

As the result, the lower screen is constantly displayed in high details, while the upper half is transmitted using a lower-quality format. Although the upper half is transmitted using a lower quality format, you still have an awareness of what is happening on the whole screen.



- **Hybrid:** The major difference between the “Manual” mode and the “Hybrid” mode is that:

In the “**Hybrid**” mode, any objects entering the non-interested area will restore the video quality of the moving objects and the area around them. The video quality of the associated non-interested area is immediately restored to normal to cover the moving objects.

In the “**Manual**” mode, the non-interested area is always transmitted using a low-quality format regardless of the activities inside.



- **Quality priority:** Use the slide bar to tune the quality contrast between the ROI and non-interested areas.

The farther the slide bar button is to the right, the higher the image quality of the ROI areas. On the contrary, the farther the slide bar button to the left, the higher the image quality of the non-interested area.

In this way, you may set up an ROI window as a privacy mask by covering a protected area using an ROI window, while the remaining screen become the non-interested area. You may then configure the non-interested area to have a high image quality, or vice versa.

You should also select the Maximum bit rate from the pull-down menu as the threshold to contain the bandwidth consumption for both the high- and low-quality video sections in a smart stream.

Audio

The Audio window allows you to configure all audio codec, sampling rate, and Microphone input gains. Depending on design of the camera models, some codecs may not be available. Also, there are cameras that come without embedded microphones.

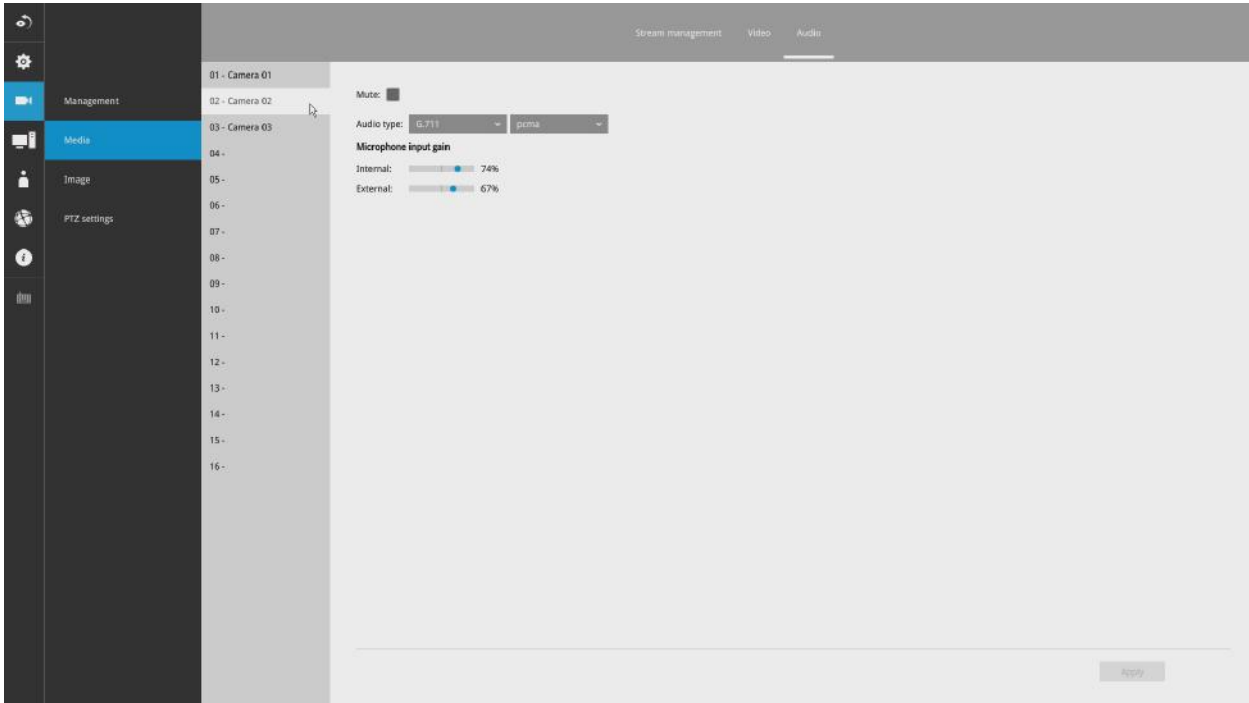

3-3-2. Settings - System - Information

On this window, you can configure the following:

1. Change the system name.
2. Select the UI text language.
3. Configure system time, time zone, and if you are connected to a DNS server where Auto Daylight Saving time can be applied, you can acquire the associated setting from a server within your network.
4. Click the **Apply** button for the configuration to take effect.

Note that if **NTP** time server configuration (Auto) is preferred, the system will automatically configure all cameras to be listening to the system, and therefore to the same time server.

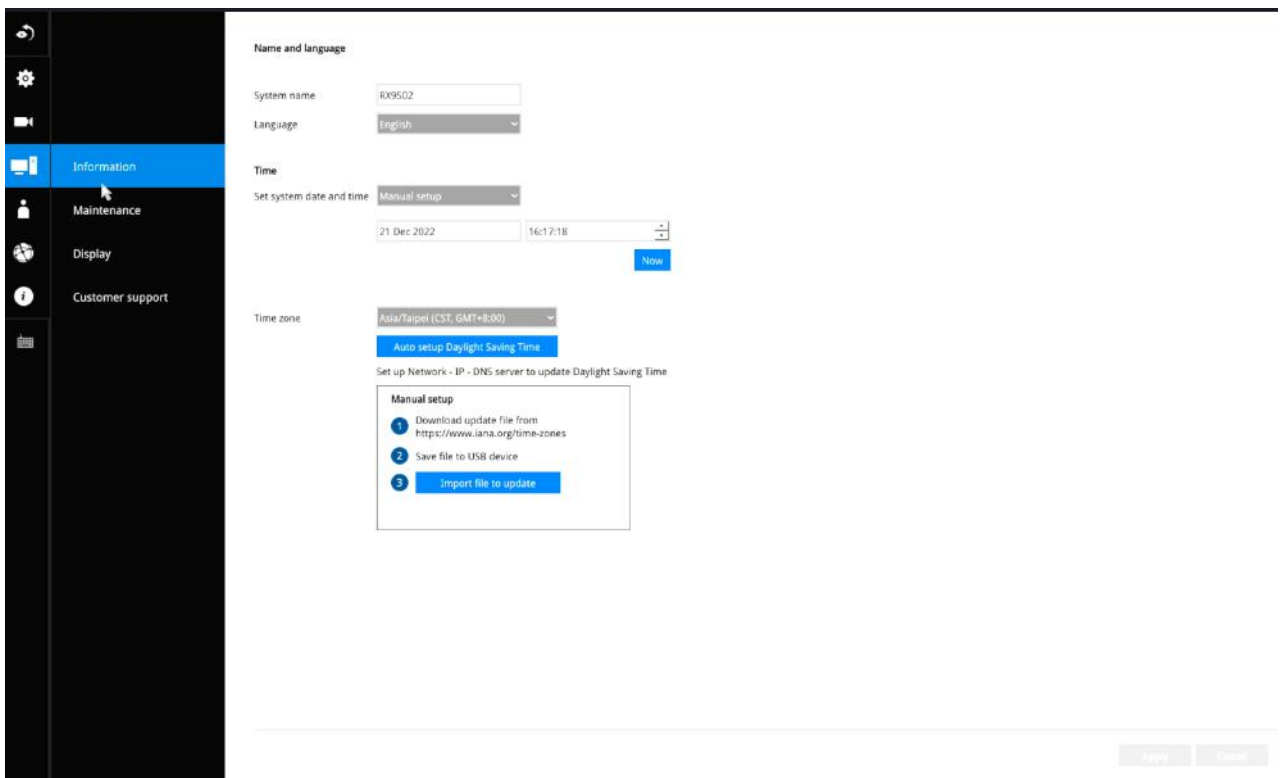

3-3-2. Settings - System - Maintenance

If the need arises for updating system firmware, acquire the update from VIVOTEK's technical support or download site. Locate the firmware binaries, and click the Import button. The upgrade should take several minutes to complete. Note that during the upgrade, the live display task will be interrupted.

On this window, you can perform 4 maintenance tasks:

1. **Update firmware** - Download firmware and save it to a USB drive in the FAT format, attach the USB device to the Receiver for firmware upgrade.
2. **Update device pack** - A device pack allows you to import associated configurations and parameters for new camera models so that these cameras can be integrated into your Receiver configuration. The information in the device pack is related to some tunable parameters.
3. **Backup** - You can backup your system configuration using the Backup function. Click Backup, a message window will prompt. Click Save to preserve your system configurations.

Select a location for your backup file, then click Save to complete the process. If you back up to a USB thumb drive, that thumb drive must be formatted using the FAT format.

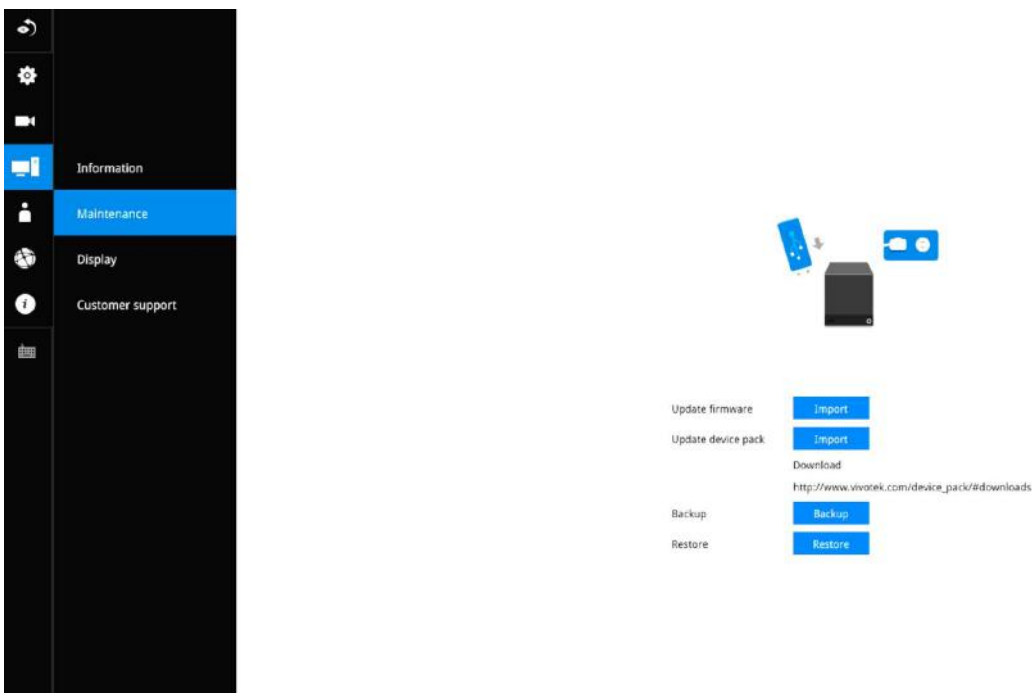

Note that the backup action does not involve the following:

1. Recorded videos and database,
 2. Alarm records, bookmarks, and bookmarked footages.
4. **Restore** - If you have a previously-saved profile, you can restore your previous configuration. Click the Restore button.

A file location window will prompt. Locate the backup file, and click Open. The Restore process will take several minutes to complete, and system operation will be interrupted during the process.

3-3-3. Settings - System - Display

On this page, you can configure the system to consecutively display (rotate) cameras' view cells on the Liveview window. For example, if you have 8 cameras in 2x2 layouts, the rotation can let you see the live views of all cameras by every few seconds.

You can also enable or disable the Alarm notification.

Output resolution: If your monitor or TV supports the 4K resolution, you can select the 4K resolution at the frame rate of 30fps. This setting depends on the maximum resolution of your display device.

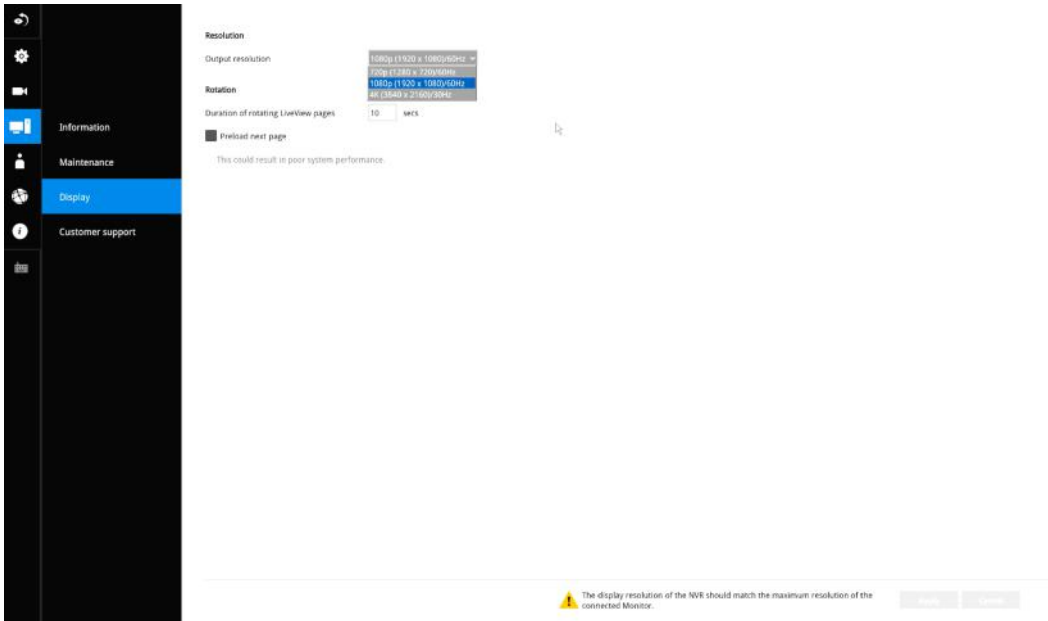

To enable the rotate function, click on the rotate button on the layout panel.

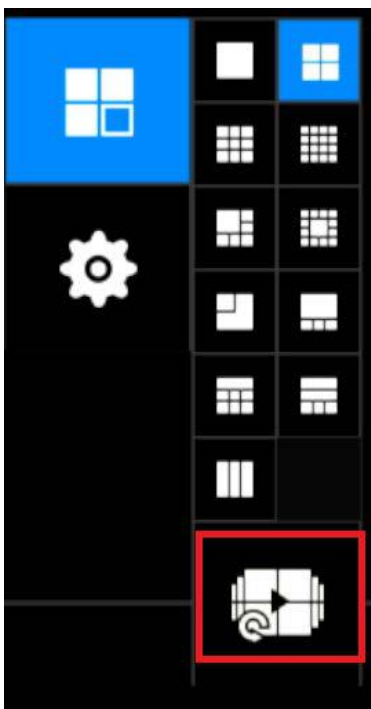

3-4. Settings - User

The User window allows you to change the administrator's password.

1. By default, there is only one user type: **Administrator**.
2. The administrator users can access all cameras recruited in the configuration.

You can create new users using the add button, and create credentials and designate the access rights to individual cameras.

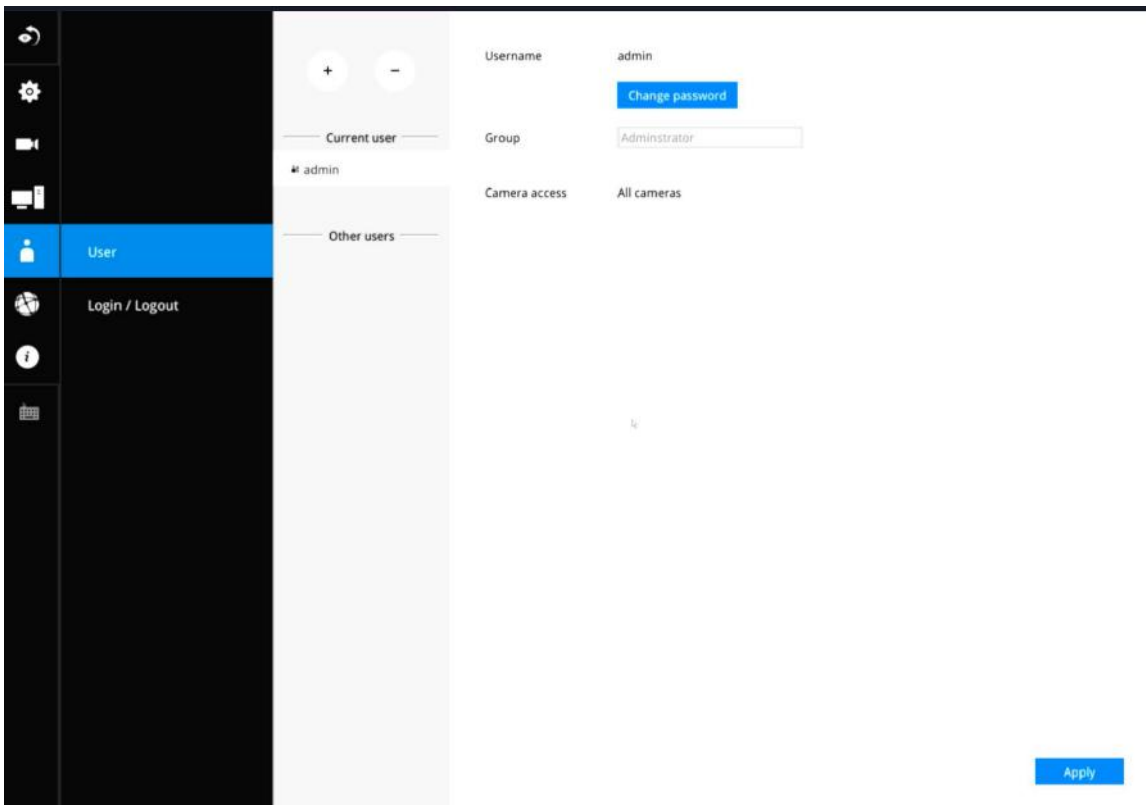

The max. number of characters for the administrator password is 64, with the combination of alphabetic and numeric characters including `[0-9][a-z][A-Z][_][][-].[,]@`.

IMPORTANT:

It is highly recommended to change the default password to prevent unauthorized access to the system.

3-4-1. Login / Logout

Login

1. **Login required to view live streaming:** If selected, users will be required to enter his/her credentials before displaying a live view. If not selected, the Receiver displays live view first. Login will be required when performing specific tasks, such as entering the Settings page.

Auto Logout should also be enabled when the receiver can be left unattended for an extended period of time. Default is 10 minutes.

Camera views will be available for users according to their privilege settings as designated in the User account configuration. Some camera views will be available for some users, while others are not.

2. **Move authorized cameras to the beginning of live view (regular users only):** For users who have access to specific cameras only, he will be required to enter his credentials before viewing a live view.

Logout

1. **Enable auto logout:** By default, a user is logged out automatically after being idle for 10 minutes. If not selected, the Receiver will not log out automatically. A user can only log out manually.

3-5. Settings - Network

Settings - Network - IP

DHCP: Default is selected, the server obtains an available dynamic IP address assigned by the DHCP server each time the system is connected to the LAN.

Manual setup: Select this option to manually assign a static IP address to the Network Camera.

Enter the Static IP, Subnet mask, Default router, and Primary DNS provided by your ISP.

Subnet mask: This is used to determine if the destination is in the same subnet. The default value is "255.255.255.0".

Default router: This is the gateway used to forward frames to destinations in a different subnet. Invalid router setting will fail the transmission to destinations in different subnet.

Primary DNS: The primary domain name server that translates hostnames into IP addresses.

Secondary DNS: Secondary domain name server that backups the Primary DNS.

When finished with the network settings, click on the **Apply** button.

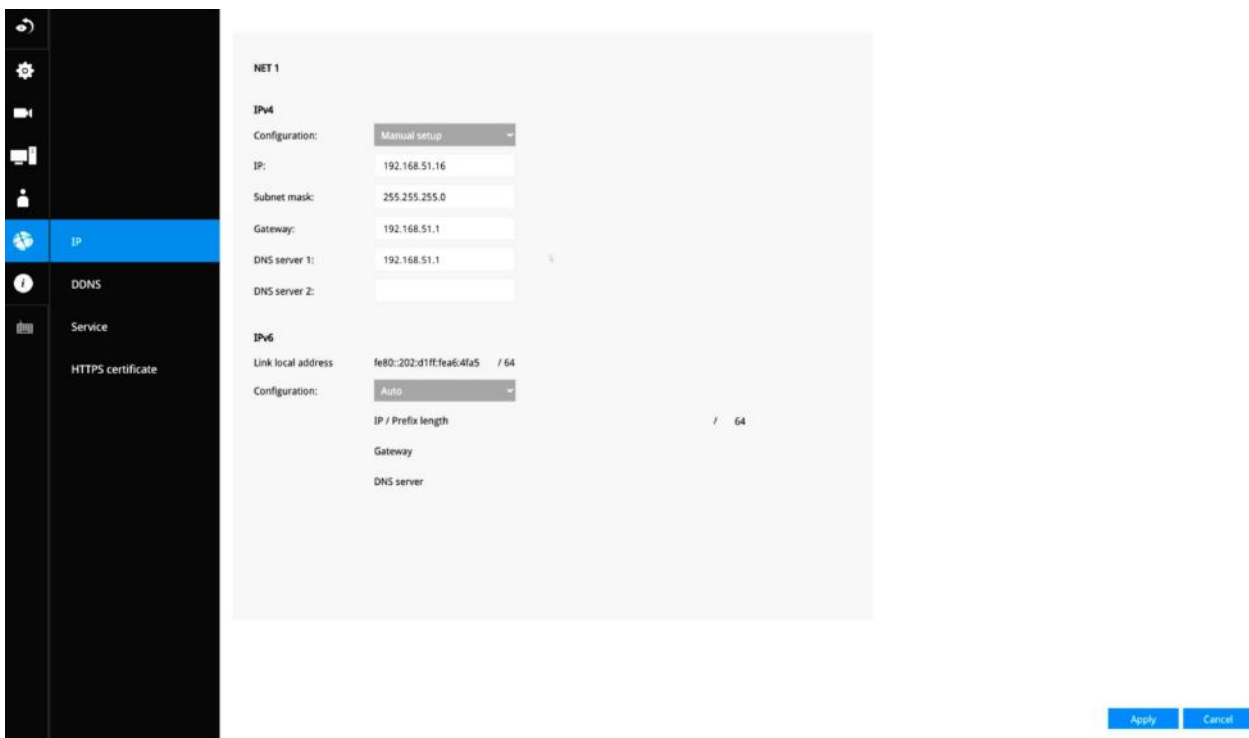

Settings - DDNS

VIVOTEK provides Dyndns.org, as a free DDNS dynamic domain name service for users who want access from the internet or a domain name service for the Receiver. VIVOTEK maintains a database of product MAC addresses for the service, and you can apply one domain name for each Receiver system.

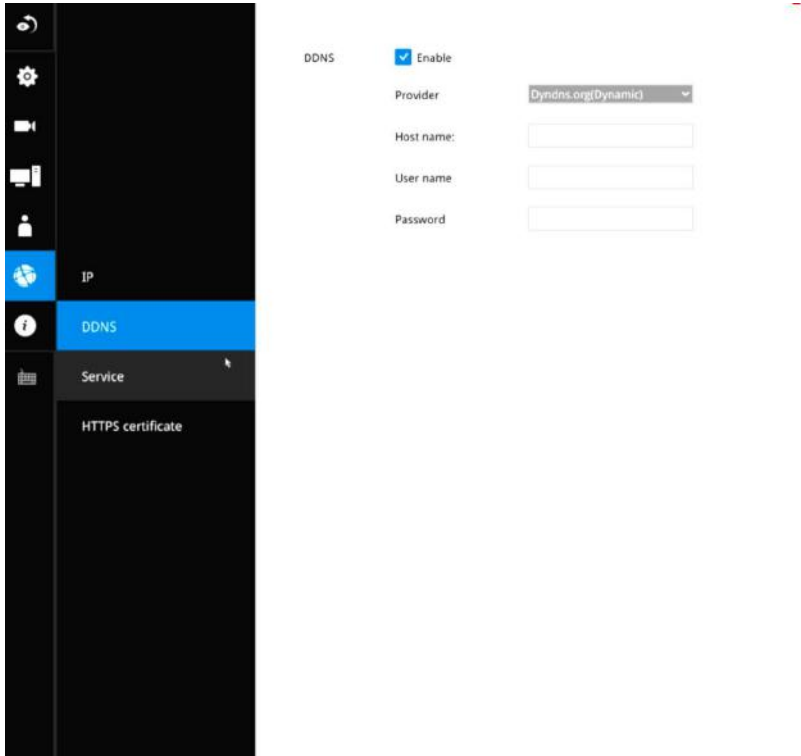

DDNS Enable: Select this checkbox to enable the DDNS setting.

Enter a Host name, Email address, and password twice, and then click **Apply** to proceed.

Make sure you have internet access.

Click the **Register** button. The terms of service agreement window is selected from a checkbox at the bottom. Click  to read the license agreement terms.

The acceptable characters for email address are: [0-9][a-z][A-Z][!][#]([\$][%]['[*][+][-]/][=?][^]_][\][{}][|][~][.]. Two successive periods, [..], are not acceptable. The address filed can accommodate up to 256 characters.

Use only alphabetic and numeric characters for the password. The maximum number of characters is 64.

When completed, a confirm message will prompt. You will also receive a confirm Email. You can now access your Receiver system using the xxx.Dyndns.org domain name address. Note that access from the Internet should be routed to the private IP assigned to your Receiver, using methodologies such as port forwarding, etc.

Settings - Service

By default, the Receiver service and video streaming are accessed via HTTP port 80 and RTSP port 554. You can designate a different port number if the need arises. Usually it is not necessary to change these ports. HTTPS encrypted connection is enabled by default.

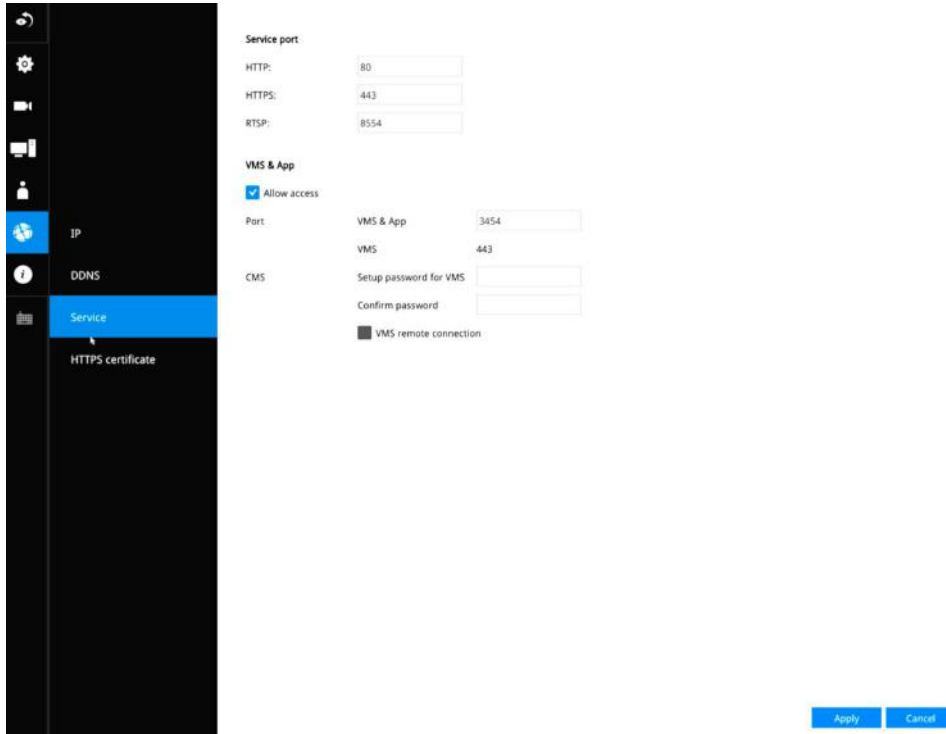

Instead of a web console, you can also access the Receiver and the subordinate cameras using VIVOTEK's **VSS** software. The Receiver can be managed as one of the sub-stations in a hierarchical device structure.

Set up a password for access from the VSS server before you can join the Receiver to a VSS centralized management configuration. For access from the iViewer, you log in using the same user name and password for the login to the Receiver.

Below is the screen showing the sub-station recruitment process from a VSS server.

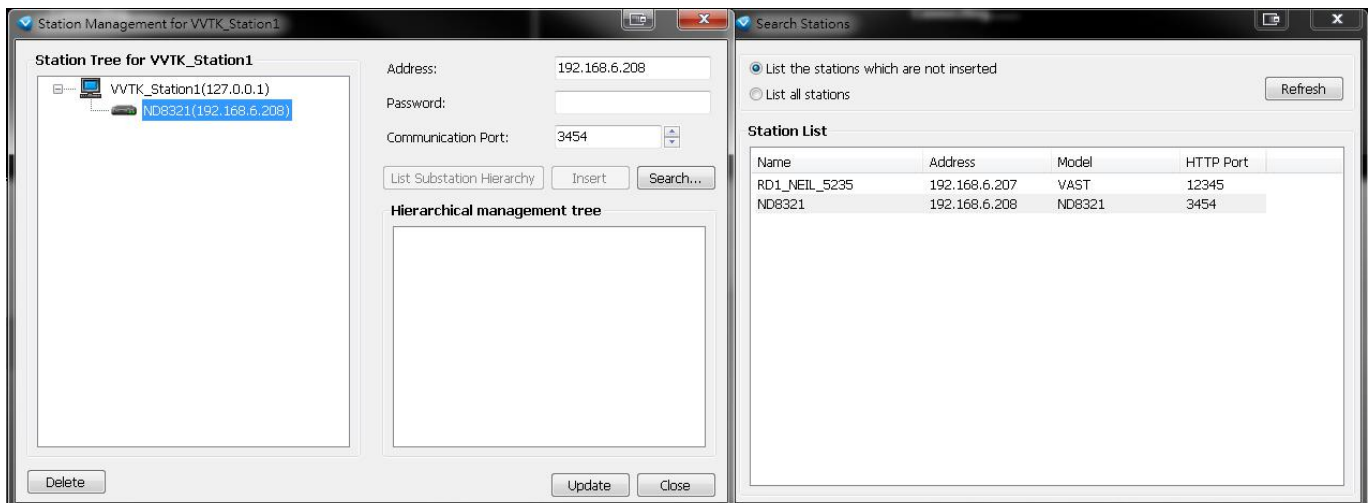

VSS auto connection

NAT-traversal with OpenVPN

You can select the "VSS Server with OpenVPN" option when installing the VSS server. A remote connection from Receiver via a 3G/4G/LTE network can be made through an OpenVPN tunnel. When the OpenVPN option is selected, an OpenVPN server will be installed with the VSS server.

HMAC authentication and TLS encryption over an encrypted UDP connection are made effortlessly using the traversal methodology.

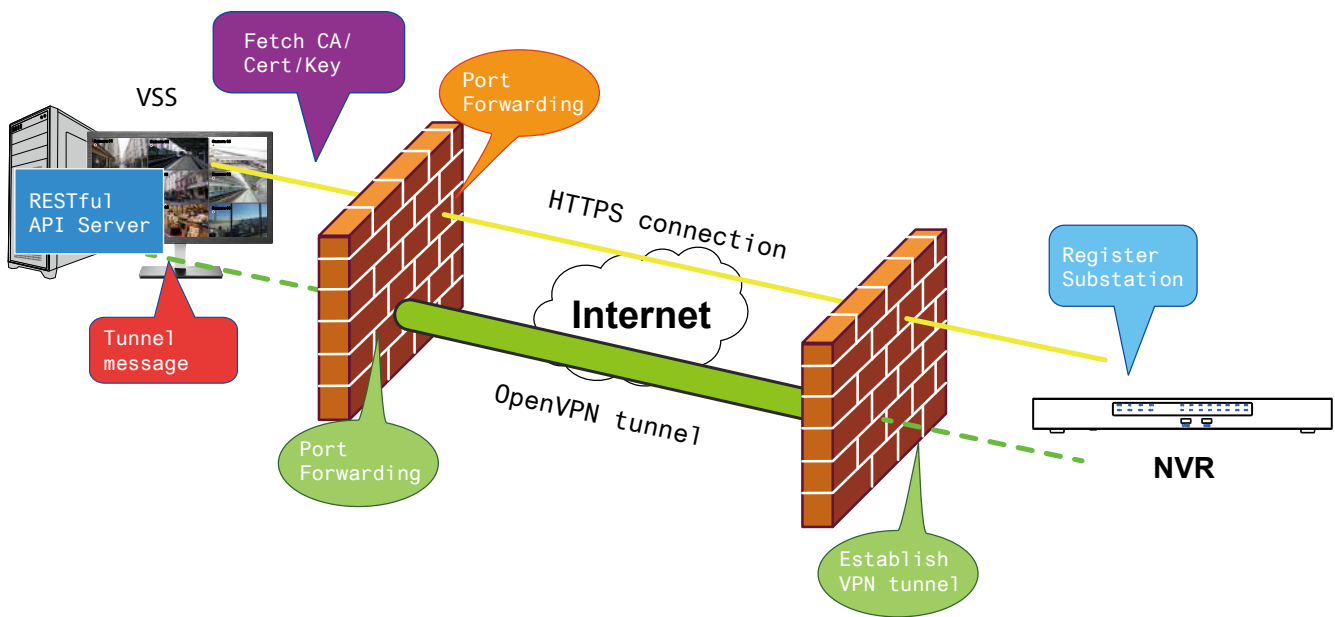

The sample installation screens are shown below:

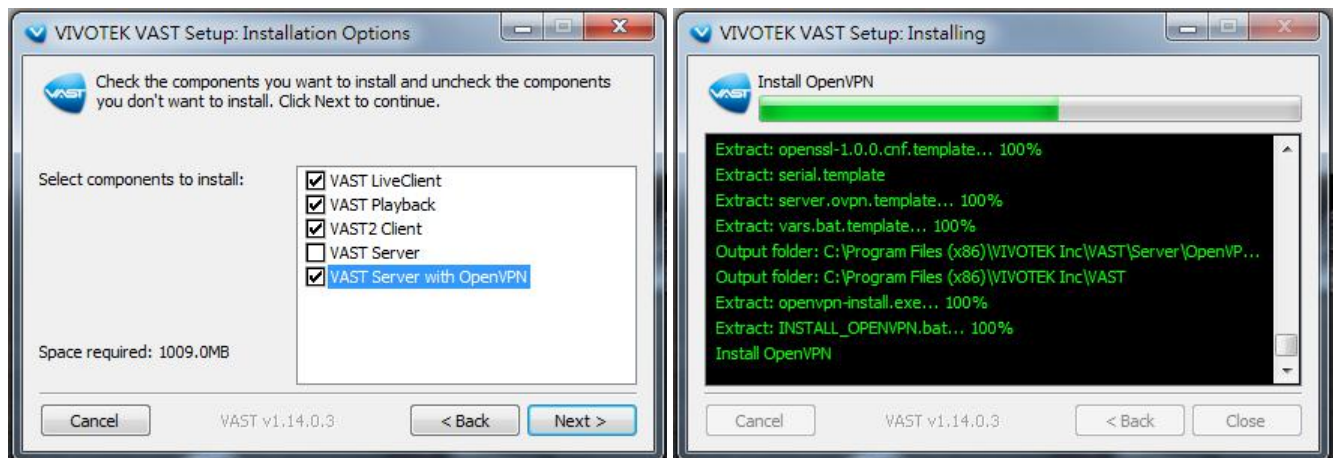

With a remote VSS instance that needs to access the Receiver via the Internet, you can enter its public IP address and credentials. The Receiver runs an Open VPN client that makes remote connection via the RESTful (Representational State Transfer) API (Application Programming Interface) service to a VPN server running on the remote site. The applicable service port number ranges from 1 to 65534. Default is 3443. The Receiver automatically registers with CA cert key and becomes with sub-station over a VPN tunnel. Once set, the VSS can automatically connects the Receiver.

A public IP or domain name must be configured on the VSS server for the access through the Internet. The IP or domain name can contain alpha-numeric characters [0-9][a-z][A-Z][-]. [-] can not be the beginning or the ending character.

Note that on the side of the VSS server making connection via the OpenVPN, the server/client configuration should be properly configured. On the mobile Receiver, a proper gateway setting should be made for VPN connection.

For the server configuration, the configuration file is placed in:

[C:\Program Files \(x86\)\VIVOTEK Inc\VSS\Server\OpenVPN\config\server\server.ovpn](C:\Program Files (x86)\VIVOTEK Inc\VSS\Server\OpenVPN\config\server\server.ovpn)

You can edit your VPN IP subnet parameters according to your network configuration. The contents of the editable text file looks like this:

```
port 3939
proto udp
dev tun
ca ca.crt
cert server.crt
key server.key
dh dh.pem
server 10.6.0.0 255.255.0.0
topology subnet
client-to-client
client-config-dir "C:\\Program Files (x86)\\VIVOTEK Inc\\VSS\\Server\\OpenVPN\\
ccd"
keepalive 10 30
cipher AES-256-CBC
max-clients 50000
persist-key
persist-tun
status openvpn-status.log
log-append openvpn.log
verb 3
mute 20
sndbuf 262144
rcvbuf 262144
tls-server
```

Note that the receiver and VSS server should have a similar time setting when exchanging certificate information. Otherwise, the mutual handshake authentication process may fail.

Enter the OpenVPN DNS domain name and the credentials on the Receiver network service configuration page.

A public IP or domain name must be configured on the VSS server for the access through the Internet. The IP or domain name can contain alpha-numeric characters [0-9][a-z][A-Z][-]. Hyphen [-] can not be the beginning or the ending character.

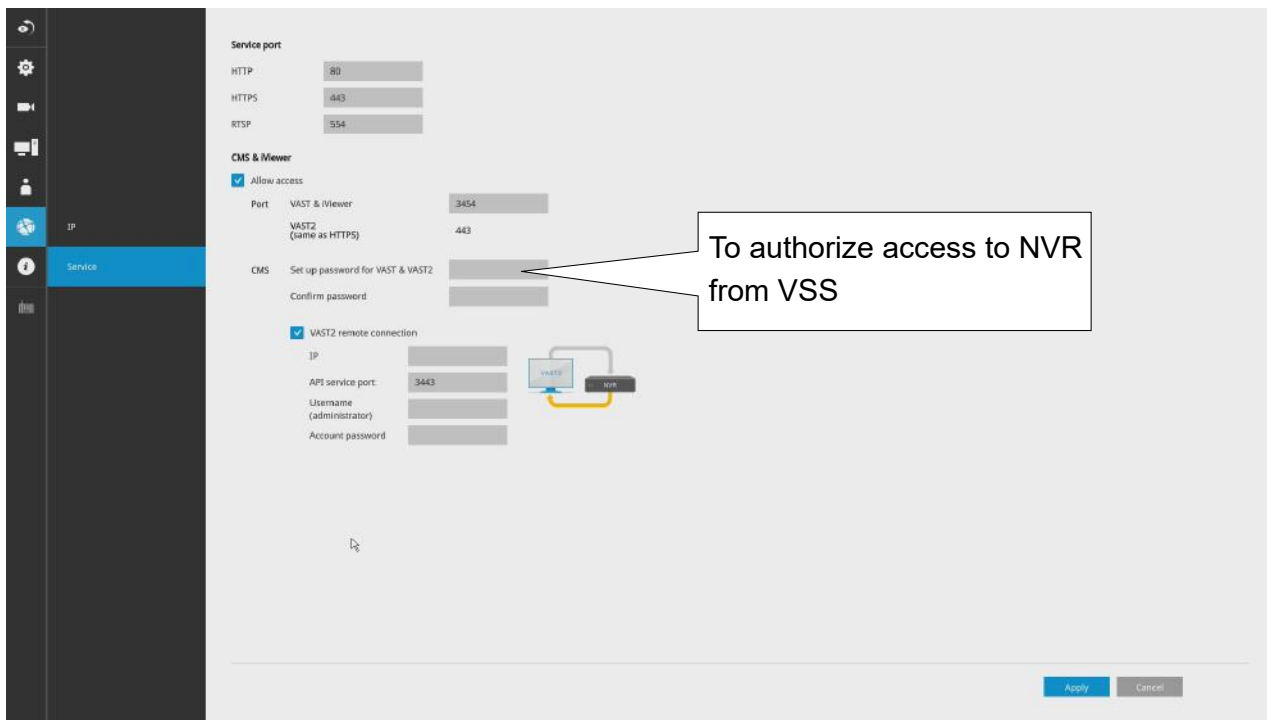

3-6. HTTPS certificate

This window allows the export, import, and to create an HTTPS certificate for secure connection to the receiver.

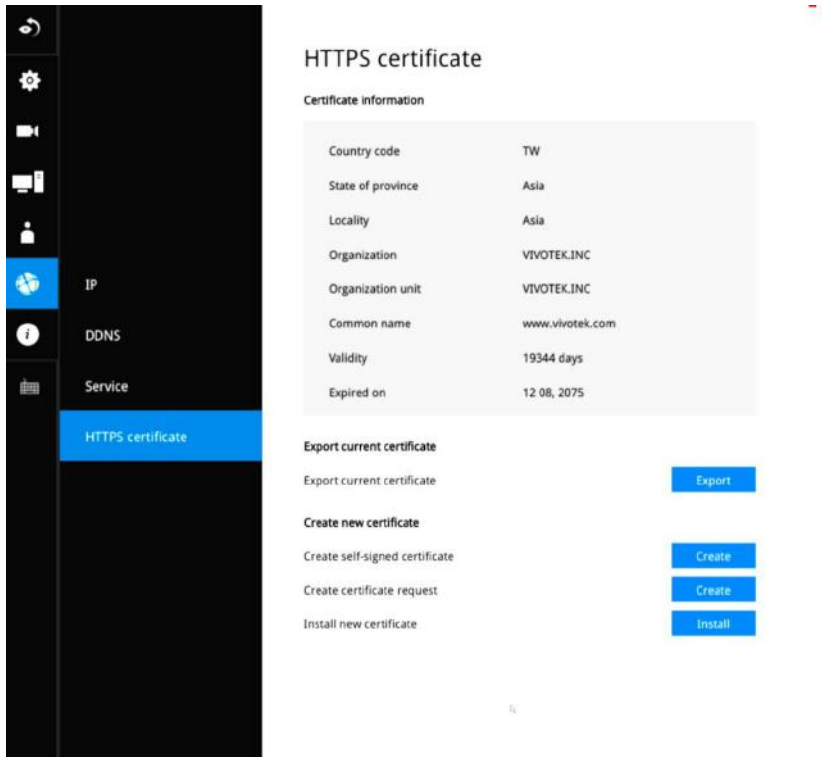

3-7. User

The User window allows you to create more users, to change user password, and place limitations on users' privileges and administration rights. Up to 16 users can be created, including the default administrator.

1. By default, there are two user groups: **Administrator** and **Regular user**.
2. The regular users cannot access the **Settings** window, meaning that regular users can not add or remove cameras, make changes to alarm, network, and all other system settings. When users try to access the Settings window, the login window prohibits regular users to log in. There is simply no regular user's name on the login window.
3. The administrator users can access all cameras recruited in the configuration; while the regular users can be configured to have access to some or all cameras.
4. The system blocks out the video feeds from users who are denied of the access to particular cameras.

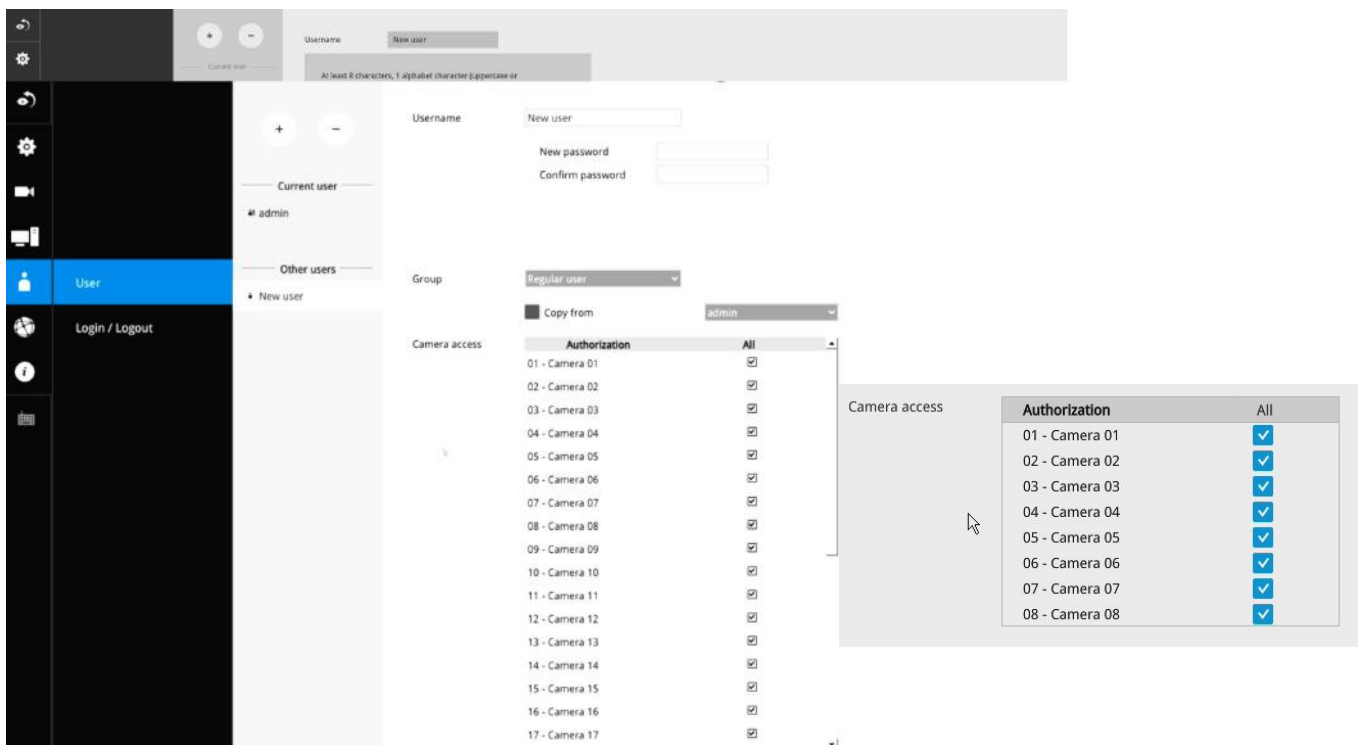

⚠ IMPORTANT:

The default administrator name and password are: admin and admin. It is highly recommended to change the default password to prevent unauthorized access to the system.

To create or edit users,

1. Select a User group by unfolding its pull-down menu. Select either an Administrator or regular user as the user group.

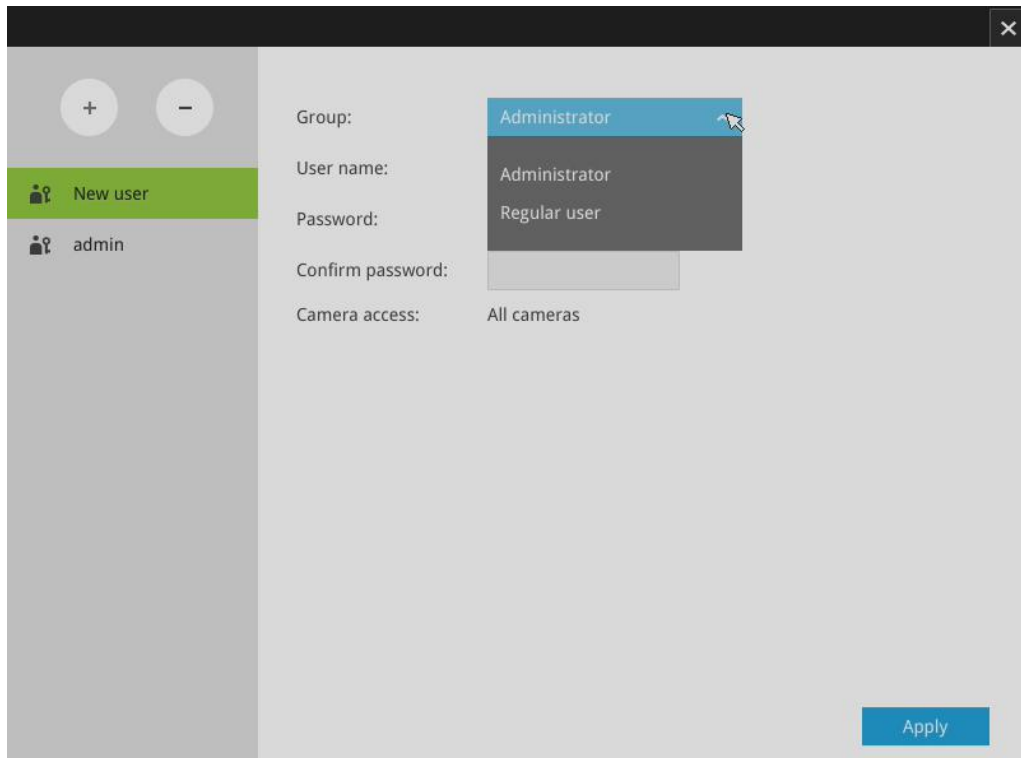

2. Enter the User name and password. The max. number of characters for a user name is 64, with alphabetic and numeric characters including [0-9][a-z][A-Z][_][!][-].[,][@]. The max. number for password is also 64.

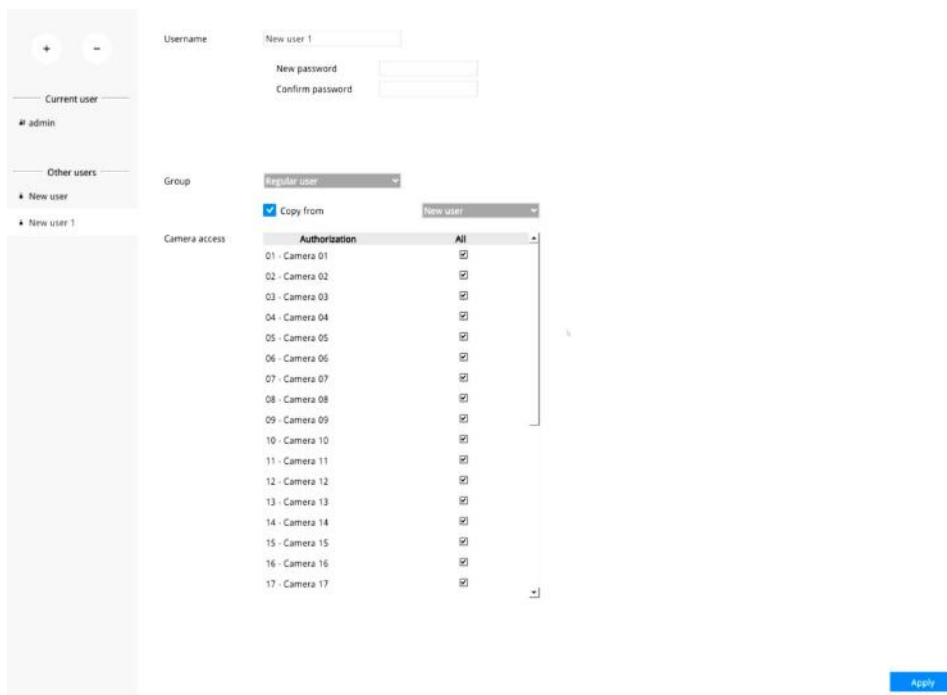

3. If you are creating a regular user with limited access to cameras, deselect the checkboxes by the cameras to deny the user access.
4. Click **Apply** to close the configuration window. Repeat the process to create more users.

Settings–User-Login / Logout

Login

1. **Login required to view live streaming:** If selected, users will be required to enter his/her credentials before displaying a live view. If not selected, the Receiver displays live view first. Login will be required when performing specific tasks, such as entering the Settings page.

Auto Logout should also be enabled when the Receiver can be left unattended for an extended period of time. Default is 10 minutes.

Camera views will be available for users according to their privilege settings as designated in the User account configuration. Some camera views will be available for some users, while others are not.

2. **Move authorized cameras to the beginning of live view (regular users only):** For users who have access to specific cameras only, he will be required to enter his credentials before viewing a live view.

Logout

1. **Enable auto logout:** By default, a user is logged out automatically after being idle for 10 minutes. If not selected, the Receiver will not log out automatically. A user can only log out manually.

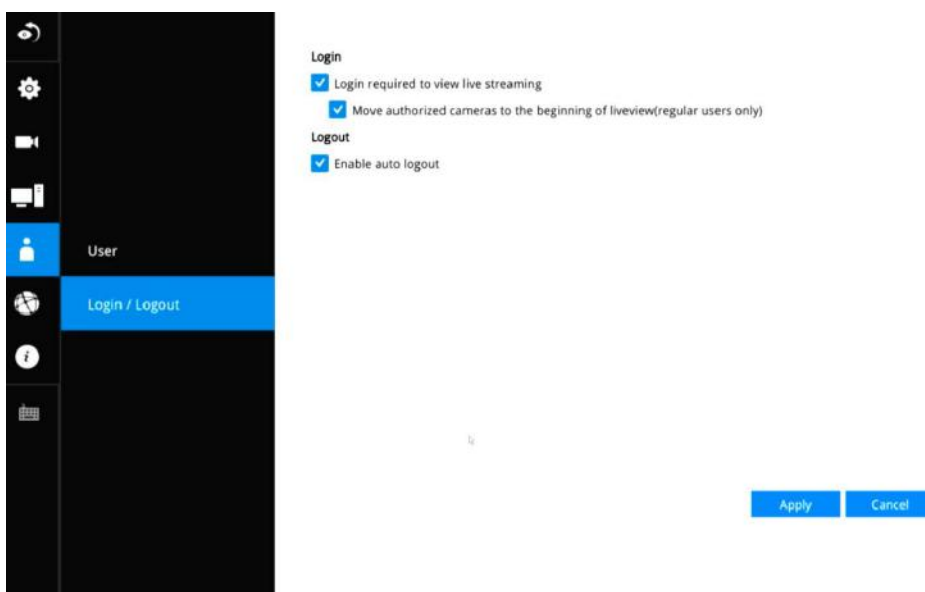

3-8. Information

This window shows the revision number of the firmware running on this machine.



Network Video Receiver

MODEL
RX9502

VERSION
4.1.1.1

DEVICE PACK
vNone



Copyright © 2023 VIVOTEK Inc. All rights reserved.

Section Two

Management over a Web Console

There are two different interfaces on the system:

1. One is connecting mouse and keyboard, and an HDMI cable to a TV or monitor. The local management thus made is described in **Section One** of this manual.
2. The other is accessed through the Ethernet connection. The management interface via a web console is identical to the local console. Please refer to the previous discussion for details.

In addition to this, only the Settings page is accessible via the web console. Live view is not available through the Ethernet connection.

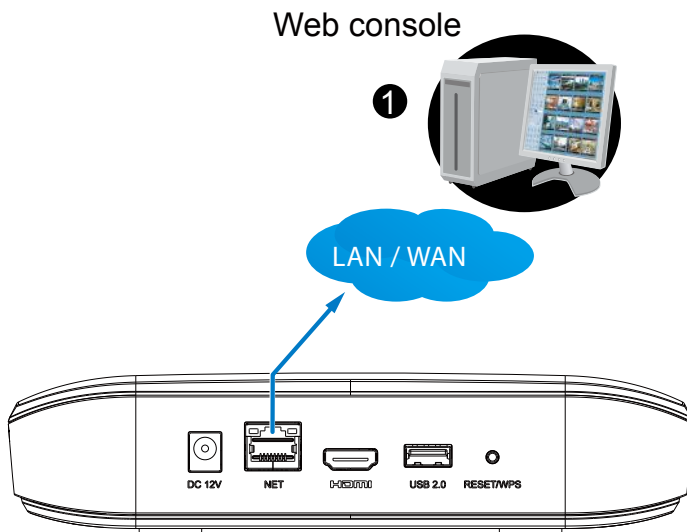

Since the Setting pages are identical, the following pages will be omitted. Please refer to page 35 for the description of the same details in System Settings via a local console.

Some minor differences between the web console and local console exist. One is the Restore Factory default function. It is only available on the web console.

On the chassis, you can press the Restore/WPS button for longer than 10 seconds to restore system defaults.

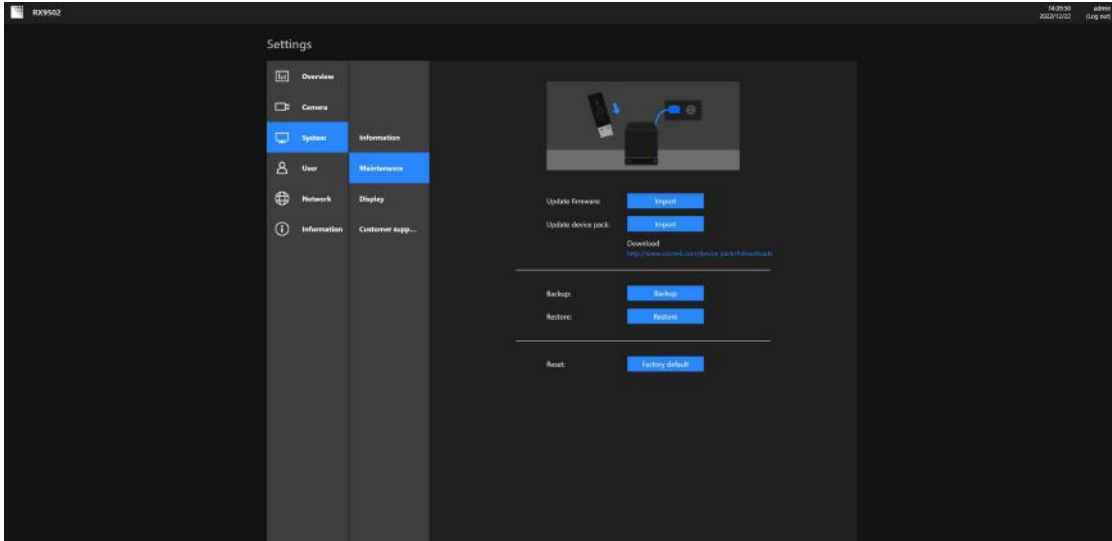

Enter the Information page to change the language used on the configuration interface.

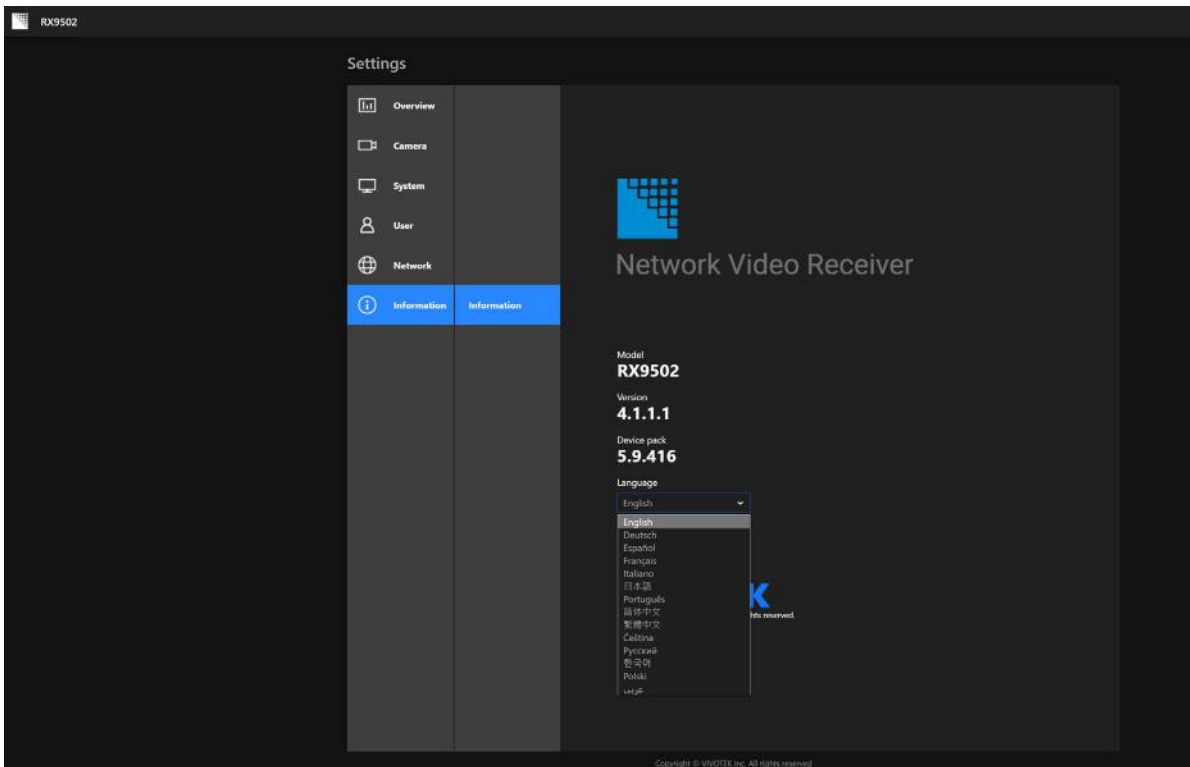

Another difference is the ability to enter a system name using languages other than English. The Receiver's system name also supports the use of other languages. This is only achievable through a web console.

The following characters are not supported:

[>][<][D][{][}][%][:][#][&][+][-][^]

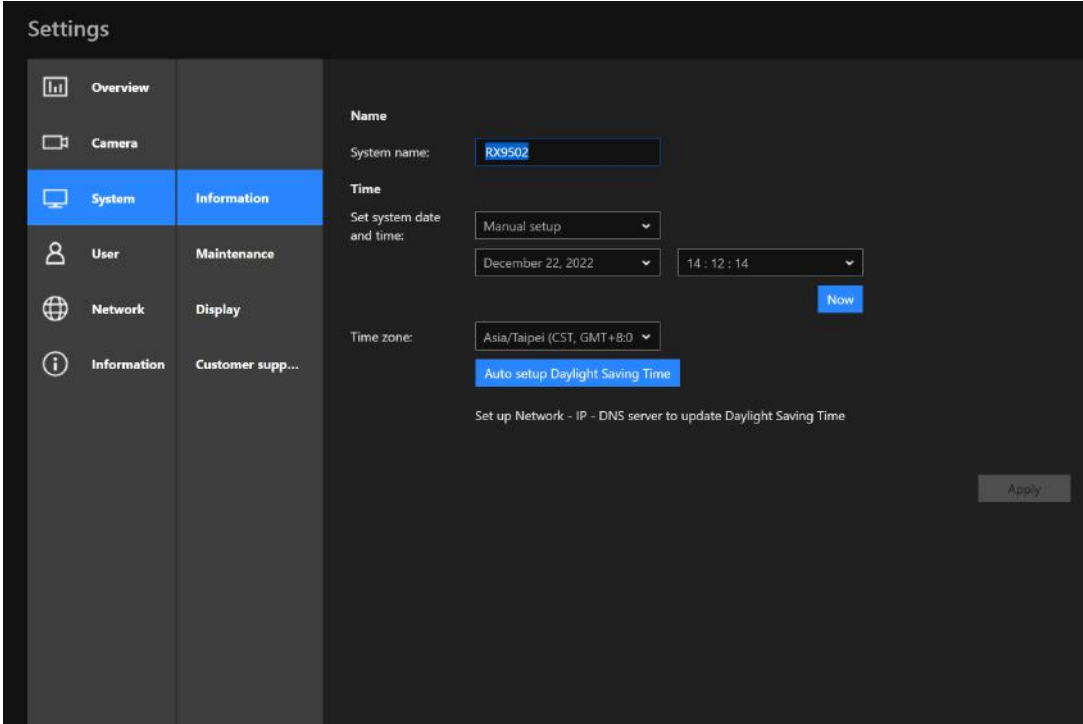

On the System > Display page, you can configure the display layout, and change the output resolution. Note that the output resolution is determined by the capability of your TV or monitor.

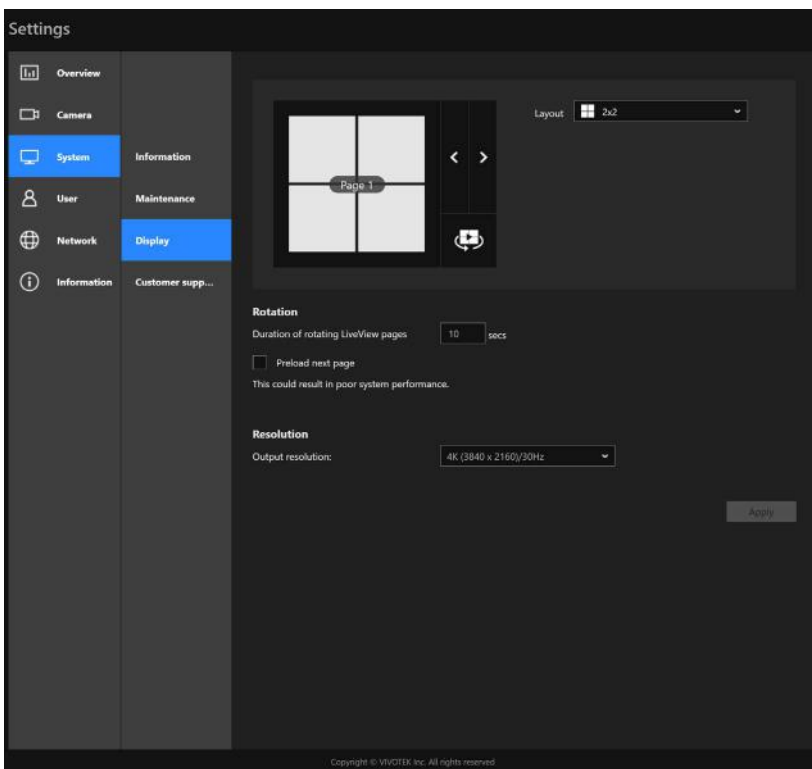

Safety and Compatibility



Federal Communications Commission (FCC) Statement

This Equipment has been tested and found to comply with the limits for a Class A digital device, pursuant to Part 15 of the FCC rules. These limits are designed to provide reasonable protection against harmful interference when the equipment is operated in a commercial environment. This equipment generates, uses and can radiate radio frequency energy and, if not installed and used in accordance with the instructions, may cause harmful interference to radio communications. Operation of this equipment in a residential area is likely to cause harmful interference in which case the user will be required to correct the interference at his own expense.

Warning:

[A shielded-type power cord is required in order to meet FCC emission limits and also to prevent interference to the nearby radio and television reception. It is essential that only the supplied power cord be used.]

[Use only shielded cables to connect I/O devices to this equipment.]

You are cautioned that changes or modifications not expressly approved by the party responsible for compliance could void your authority to operate the equipment.

[]: depend on EUT condition.



Information on Disposal for Users of Waste Electrical & Electronic Equipment (private households)

This symbol on the products and/or accompanying documents means that used electrical and electronic products should not be mixed with general household waste.

For proper treatment, recovery and recycling, please take these products to designated collection points, where they will be accepted on a free of charge basis. Alternatively, in some countries you may be able to return your products to your local retailer upon the purchase of an equivalent new product.

Disposing of this product correctly will help to save valuable resources and prevent any potential negative effects on human health and the environment which could otherwise arise from inappropriate waste handling. Please contact your local authority for further details of your nearest designated collection point.

Penalties may be applicable for incorrect disposal of this waste, in accordance with national legislation.

For business users in the European Union

If you wish to discard electrical and electronic equipment, please contact your dealer or supplier for further information.

Information on Disposal in other Countries outside the European Union

This symbol is only valid in the European Union. If you wish to discard this product, please contact your local authorities or dealer and ask for the correct method of disposal.

Japan VCCI Class A statement

この装置は、クラス A 情報技術装置です。この装置を家庭環境で使用すると電波妨害を引き起こすことがあります。この場合には使用者が適切な対策を講ずるよう要求されることがあります。 VCCI-A



ACA (Australian Communications Authority)

CAUTION
RISK OF EXPLOSION IF BATTERY IS REPLACED
BY AN INCORRECT TYPE.
DISPOSE OF USED BATTERIES ACCORDING TO THE INSTRUCTIONS