

# XNV-6022RM

2M Mobile Vandal-Resistant Network IR Flat Camera



## Key Features

- Max. 2Megapixel (1920 x 1080) resolution
- Max. 60fps@all resolutions (H.265 / H.264)
- 0.04Lux@F2.0 (Color), 0Lux (B/W : IR LED On)
- Built-in 3.6mm fixed lens
- H.265, H.264, MJPEG codec supported, Multiple streaming
- Day & Night (ICR), WDR (150dB)
- Tampering, Loitering, Directional detection, Defocus detection, Fog detection, Virtual line, Enter/Exit, (Dis)Appear, Audio detection, Face detection, Digital auto tracking, Sound classification
- Motion detection, Handover
- SD/SDHC/SDXC memory slot (Max. 256GB)
- IR viewable length 15m, IP66, IK10, NEMA4X
- Hallway view, PoE, LDC, M12 connector support

## Dimensions

Unit : mm (inch)

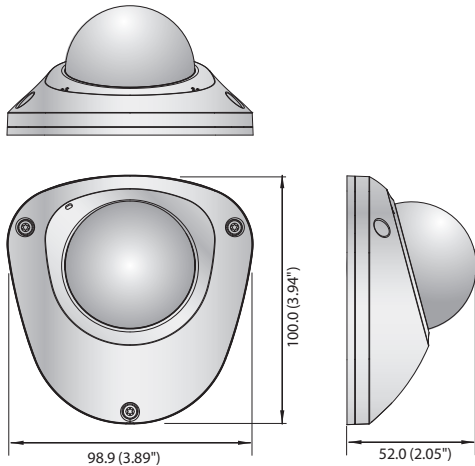

## XNV-6022RM

<b>VIDEO</b>	
Imaging Device	1/2.8" 2M CMOS
Total Pixels	1,945(H) x 1,109(V) 2.16M
Effective Pixels	1,945(H) x 1,097(V) 2.13M
Scanning System	Progressive Scan
Min. Illumination	Color : 0.04Lux (F2.0), B/W : 0Lux (IR LED On)
S / N Ratio	50dB
Video Out	USB : Micro USB type B, 1280 x 720, for installation
<b>LENS</b>	
Focal Length (Zoom Ratio)	3.6mm fixed
Max. Aperture Ratio	F2.0
Angular Field of View	H : 94.8° / V : 49.3° / D : 114.3°
Focus Control	Manual
Lens / Mount Type	Fixed / Board type
<b>PAN / TILT / ROTATE</b>	
Pan / Tilt / Rotate Range	±5° / 0° ~ 67° / ±90°
<b>OPERATIONAL</b>	
IR Viewable Length	15m (49.21ft)
Camera Title	Off / On (Displayed up to 85 characters) - W/W : English / Numeric / Special characters - China : English / Numeric / Special / Chinese characters - Common : Multi-line (Max. 5), Color (Gray / Green / Red / Blue / Black / White), Transparency, Auto scale by resolution
Day & Night	Auto (ICR) / Color / B/W / Schedule
Backlight Compensation	Off / BLC / HLC (Masking / Dimming), WDR
Wide Dynamic Range	150dB
Contrast Enhancement	SSDR (Off / On)
Digital Noise Reduction	SSNRV (2D + 3D noise filter) (Off / On)
Digital Image Stabilization	Off / On
Defog	Off / Auto / Manual
Motion Detection	Off / On (8ea, 8point polygonal zones), Handover
Privacy Masking	Off / On (32ea, polygonal zones) - Color : Gray / Green / Red / Blue / Black / White - Mosaic
Gain Control	Off / Low / Middle / High
White Balance	ATW / AWC / Manual / Indoor / Outdoor (Included mercury & Sodium)
Contrast	Level adjustment
LDC (Lens Distortion Correction)	Off / On (5 Levels with min / max)
Electronic Shutter Speed	Minimum / Maximum / Anti flicker (2 ~ 1/12,000sec)
Digital PTZ	24x, Digital PTZ (Preset, Group)
Flip / Mirror	Off / On, Hallway view : 90°/270°
Video & Audio Analytics	Tampering, Loitering, Directional detection, Defocus detection, Fog detection, Virtual line, Enter/Exit, (Dis)Appear, Audio detection, Face detection, Motion detection, Digital auto tracking, Sound classification (w/ external MIC)
Alarm Triggers	Motion detection, Video & Audio analytics, Network disconnect
Alarm Events	File upload via FTP, E-mail, Notification via E-mail, Local storage (SD/SDHC/SDXC) or NAS recording at event triggers, External output, DPTZ preset
Audio Noise Reduction	Off / On
Pixel Counter	Support
<b>NETWORK</b>	
Ethernet	M12 connector (10/100 BASE-T)
Video Compression Format	H.265 / H.264 (MPEG-4 part 10/AVC) : Main / Baseline / High, MJPEG
Resolution	1920 x 1080, 1280 x 1024, 1280 x 960, 1280 x 720, 1024 x 768, 800 x 600, 800 x 448, 720 x 576, 720 x 480, 640 x 480, 640 x 360, 320 x 240
Max. Framerate	H.265 / H.264 : Max. 60fps at all resolutions, MJPEG : Max. 30fps
Smart Codec	Manual mode (Area-based : 5ea)
WiseStream II	Support
Video Quality Adjustment	H.265 / H.264, MJPEG : Target bitrate level control
Bitrate Control Method	H.265 / H.264 : CBR or VBR, MJPEG : VBR
Streaming Capability	Multiple streaming (Up to 10 profiles)
Audio In	Selectable (Mic in / Line in), Built-in microphone Supply voltage : 2.5V DC (4mA), Input impedance : approx. 2K Ohm
Audio Out	Line out, Max output level : 1Vrms
Audio Compression Format	G.711 u-law/G.726 selectable, G.726 (ADPCM) 8KHz, G.711 8KHz, G.726 : 16Kbps, 24Kbps, 32Kbps, 40Kbps, AAC-LC : 48Kbps at 16KHz
Audio Communication	Bi-directional (2-Way)
IP	IPv4, IPv6
Protocol	TCP/IP, UDP/IP, RTP (UDP), RTP (TCP), RTP/RTSP, NTP, HTTP, HTTPS, SSL/TLS, DHCP, PPPoE, FTP, SMTP, ICMP, IGMP, SNMPv1/v2c/v3 (MIB-2), ARP, DNS, DDNS, QoS, UPnP, Bonjour
Security	HTTPS (SSL) login authentication, Digest login authentication, IP address filtering, User access log, 802.1X authentication (EAP-TLS, EAP-LEAP)
Streaming Method	Unicast / Multicast
Max. User Access	20 users at unicast mode
Edge Storage	SD/SDHC/SDXC 1 slot (up to 256GB) - Motion Images recorded in the SD/SDHC/SDXC memory card can be downloaded.
Application Programming Interface	NAS (Network Attached Storage), Local PC for instant recording
Webpage Language	ONVIF profile S/G, SUNAPI (HTTP API), Wisenet Open Platform English, Korean, Chinese, French, Italian, Spanish, German, Japanese, Russian, Swedish, Portuguese, Czech, Polish, Turkish, Dutch, Hungarian, Greek Supported OS : Windows 7, 8.1, 10, Mac OS X 10.10, 10.11, 10.12 Non-plugin Webviewer
Web Viewer	- Supported Browser : Google Chrome 54, MS Edge 38, Mozilla Firefox 49 (Window 64bit only), Apple Safari 9 (Mac OS X only) Plug-in Webviewer - Supported Browser : MS Explore 11, Apple Safari 9 (Mac OS X only)
Central Management Software	SmartViewer, SSM
<b>ENVIRONMENTAL</b>	
Operating Temperature / Humidity	-30°C ~ +55°C (-22°F ~ +131°F) / Less than 90% RH * Start up should be done at above -20°C (-4°F)
Storage Temperature / Humidity	-50°C ~ +60°C (-58°F ~ +140°F) / Less than 90% RH
Ingress Protection	IP66
Vibration Resistance	EN55011:2009+A1:2010, EN55081:2012, EN50121-3-2:2015, EN61000-4-2:2009, EN61000-4-3:2006+A2:2010, EN61000-4-4:2012, EN61000-4-5:2014, EN61000-4-6:2009, EN50155:2007, NEMA 4X
Vandal Resistance	IK10, NEMA4X
<b>ELECTRICAL</b>	
Input Voltage / Current	PoE (IEEE802.3af, Class3)
Power Consumption	Max. 6.7W
<b>MECHANICAL</b>	
Color / Material	Ivory (NCSS 0502-Y) / Metal
Dimensions (WxHxD)	98.9 x 52.0 x 100.0mm (3.89" x 2.05" x 3.94")
Weight	295g (0.65 lb)

\* The latest product information / specification can be found at [hanwha-security.com](http://hanwha-security.com)

\* Design and specifications are subject to change without notice.

\* Wisenet is the proprietary brand of Hanwha Techwin, formerly known as Samsung Techwin.