

DS-1271ZJ-135

Pendent Mounting Bracket for
Dome Camera

Features:

- Aluminum alloy material with surface spray treatment
- Waterproof design
- Cable hole on bracket makes the feature better
- Design of cap is for convenient wiring

Dimension:

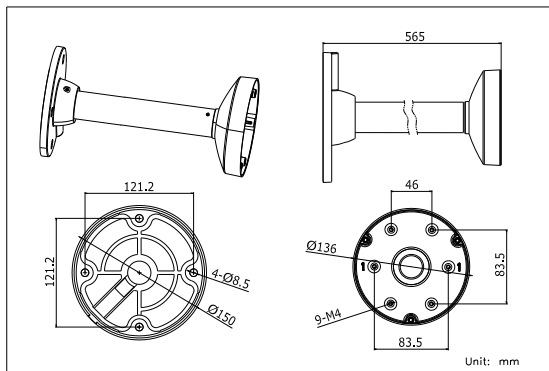

Order Model:

DS-1271ZJ-135

Parameter:

Model	DS-1271ZJ-135
Parameters	Pendent Mounting Bracket for Dome Camera
Appearance	Hikvision White
Material	Aluminum Alloy
Dimension	Φ 136×565mm
Weight	1350g

Notice:

- The bracket should be installed on flat wall
- Waterproof rubber is necessary for outdoor application
- The wall must be capable of supporting over 3 times as much as the total weight of the camera and the mount.
- The maximum load capacity of the bracket is 4.5KG

Model Suitable:

DS-2CD2712F-I(S), DS-2CD2732F-I(S), DS-2CC52xxP(N)-VP series, DS-2CC52xxP(N)-AVPIR2 series

Installation Step:

- ① Choose the appropriate wall to install the bracket and thread the cable

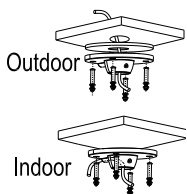

- ② Connect pole and adapter; thread cable and screw up

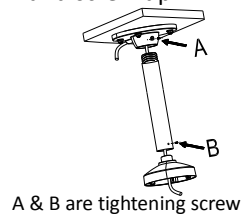

- ③ Screw up and complete the fixation of adapter and pole

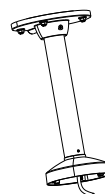

- ④ Take off lower dome and lining

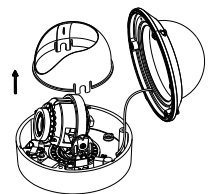

- ⑤ Install the camera to the adaptor and fix with screw

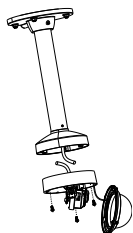

- ⑥ Complete the fixation and install the lining



- ⑦ Adjust the view of angle and install lower dome



- ⑧ Installation complete

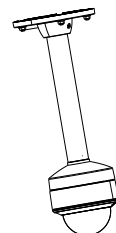

Note: The actual dome camera may vary from the picture above.