

DS-1273ZJ-135B

Wall Mounting Bracket for
Dome Camera (with Junction Box)

Features:

- Aluminum alloy material with surface spray treatment
- Design of cable entrance hole
- Better water proof design
- Junction box with waterproof stopper

Dimension:

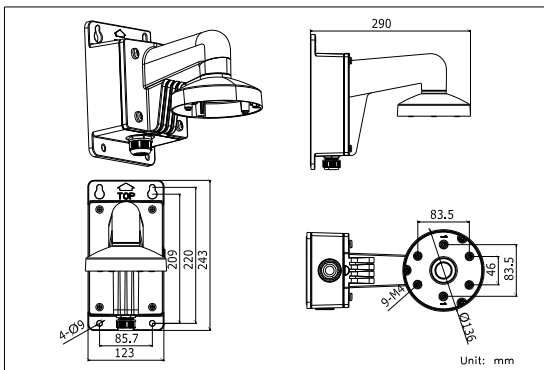

Order Model:

DS-1273ZJ-135B

Parameter:

Model	DS-1273ZJ-135B
Parameters	Wall Mounting Bracket for Dome Camera (with Junction Box)
Appearance	Hikvision White
Range of Application	Suitable for dome camera wall mounting
Material	Aluminum Alloy
Dimension	Φ 136×243×290mm
Weight	1490g

Notice:

- The bracket should be installed on flat wall
- The wall must be capable of supporting over 3 times as much as the total weight of the camera and the mount.
- The maximum load capacity of the bracket is 4.5KG

Model Suitable:

DS-2CD2712F-I (S), DS-2CD2732F-I (S), DS-2CC52X1P (N)-VP,
DS-2CC52X1P (N)-AVPIR2

Installation Step:

- ① Choose appropriate wall to install the bracket and thread the cable through waterproof stopper
- ② Fix bracket to junction box thread the cable and screw up
- ③ Fix adaptor cap to bracket with tightening screw
- ④ Take off lower dome and lining

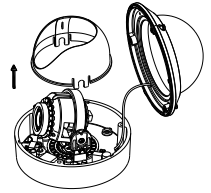
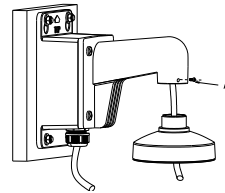
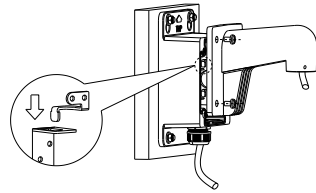
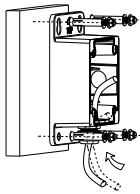

- ⑤ Install dome camera to adaptor cap and fix with screw
- ⑥ Install lining to dome camera and adjust the angle of view
- ⑦ Install lower dome to dome camera and screw up
- ⑧ Installation complete

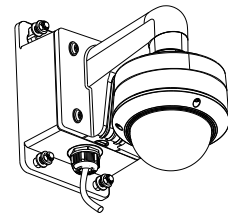
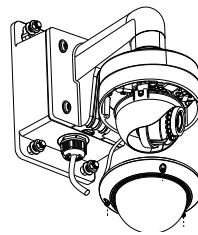
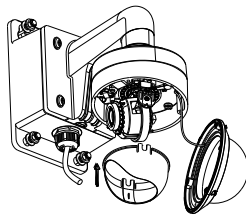
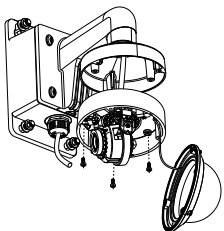

Note: The actual bracket may vary from the picture above.