

# 4MP HD Intelligent LightHunter IR VF Dome Network Camera

IPC3234SB-ADZK-IO



## Key Features



- High quality image with 4MP, 1/3"CMOS sensor
- 4MP (2688\*1520)@ 30/25fps; 4MP (2560\*1440)@ 30/25fps; 3MP (2304\*1296) @ 30/25fps; 2MP (1920\*1080) @30/25fps;
- Ultra 265, H.265, H.264, MJPEG
- Intelligent perimeter protection, include cross line, intrusion, enter area, leave area detection
- Based on target classification, smart intrusion prevention significantly reduce false alarm caused by leaves, birds and lights etc., accurately focus on human and, motor vehicle and non-motor vehicle
- LightHunter technology ensures ultra-high image quality in low illumination environment
- 120dB true WDR technology enables clear image in strong light scene
- Support 9:16 Corridor Mode
- Built-in Mic
- Alarm:1 in/1 out, Audio: 1 in/1 out
- Smart IR, up to 40m (131ft) IR distance
- Supports 256 G Micro SD card
- IK10 vandal resistant
- IP67 protection
- Support PoE power supply

## Specifications

IPC3234SB-ADZK-IO					
<b>Camera</b>					
Sensor	1/3", 4.0megapixel, progressive scan, CMOS				
Lens	2.7 ~ 13.5mm, AF automatic focusing and motorized zoom lens				
DORI Distance	Lens (mm)	Detect (m)	Observe (m)	Recognize (m)	Identify (m)
	2.7	60.8	24.3	12.2	6.1
	13.5	303.8	121.5	60.8	30.4
Angle of View (H)	98.26° ~ 31.35°				
Angle of View (V)	54.76° ~ 18.55°				
Angle of View (O)	127.74° ~ 36.99°				
Adjustment angle	Pan: 0° ~ 355°		Tilt: 0° ~ 80°		Rotate: 0° ~ 355°
Shutter	Auto/Manual, 1 ~ 1/100000s				
Minimum Illumination	Colour: 0.002Lux (F1.2, AGC ON) 0Lux with IR on				
Day/Night	IR-cut filter with auto switch (ICR)				
S/N	>56dB				
IR Range	Up to 40m (131ft) IR range				
Wavelength	850nm				
IR On/Off Control	Auto/Manual				
Defog	Digital Defog				
WDR	120dB				
<b>Video</b>					
Video Compression	Ultra 265, H.265, H.264, MJPEG				
H.264 code profile	Baseline profile, Main profile, High profile				
Frame Rate	Main Stream: 4MP (2688*1520), Max 30fps; 4MP (2560*1440), Max 30fps; 3MP (2304*1296), Max 30fps; 1080P (1920*1080), Max 30fps; Sub Stream: 720P (1280*720), Max 30fps; D1 (720*576), Max 30fps; 640*360, Max 30fps; 2CIF(704*288), Max 30fps; CIF(352*288), Max 30fps; Third Stream: D1 (720*576), Max 30fps; 640*360, Max 30fps; 2CIF(704*288), Max 30fps; CIF(352*288), Max 30fps;				
Video Bit Rate	128 Kbps~16 Mbps				
9:16 Corridor Mode	Supported				
OSD	Up to 8 OSDs				
Privacy Mask	Up to 4 areas				
ROI	Up to 8 areas				
Motion Detection	Up to 4 areas				
<b>Image</b>					
White Balance	Auto/Outdoor/Fine Tune/Sodium Lamp/Locked/Auto2				
Digital Noise Reduction	2D/3D DNR				
Smart IR	Support				
Flip	Normal/Vertical/Horizontal/180°/90°Clockwise/90°Anti-clockwise				
Dewarping	N/A				
HLC	Supported				

BLC	Supported
<b>Intelligent</b>	
Smart Intrusion Prevention	Cross Line, intrusion, enter area, leave area detection;
<b>Events</b>	
Basic Detection	Motion detection, tampering alarm, audio detection
General Function	Watermark, IP address filtering, alarm input, alarm output, access policy, ARP Protection, RTSP authentication, user Authentication
<b>Audio</b>	
Audio Compression	G.711
Two-way Audio	Supported
Suppression	Supported
Sampling Rate	8KHZ
<b>Storage</b>	
Edge Storage	Micro SD, up to 256GB
Network Storage	ANR, NAS(NFS)
<b>Network</b>	
Protocols	IPv4, IGMP, ICMP, ARP, TCP, UDP, DHCP, PPPoE, RTP, RTSP, RTCP, DNS, DDNS, NTP, FTP, UPnP, HTTP, HTTPS, SMTP, 802.1x, SNMP, QoS
Compatible Integration	ONVIF (Profile S, Profile G, Profile T), API
Client	EZStation EZView EZLive
Web Browser	Plug-in required live view: IE9+, Chrome 41 and below, Firefox 52 and below
	Plug-in free live view: Chrome 57.0+, Firefox 58.0+, Edge 16+, Safari 11+
<b>Interface</b>	
Audio I/O	Input: impedance 35kΩ; amplitude 2V [p-p]
	Output: impedance 600Ω; amplitude 2V [p-p]
Alarm I/O	1/1
Built-in Mic	Supported
Network	1 RJ45 10M/100M Base-TX Ethernet
<b>Certifications</b>	
Certifications	CE: EN 60950-1 UL: UL60950-1 FCC: FCC Part 15
<b>General</b>	
Power	DC 12V±25%, PoE (IEEE 802.3af)
	Power consumption: Max 7.0W
Dimensions (Ø x H)	Φ148 x 111.3mm (Ø5.8" x 4.4")
Net Weight	0.92kg (2.03lb)
Material	Metal + Plastic
Working Environment	-30°C ~ 60°C (-22°F ~ 140°F), Humidity: ≤95% RH (non-condensing)
Storage Environment	-30°C ~ 60°C (-22°F ~ 140°F), Humidity: ≤95% RH (non-condensing)
Surge Protection	6KV
Ingress Protection	IP67
Vandal Resistant	IK10

Reset Button

Supported

## Dimensions

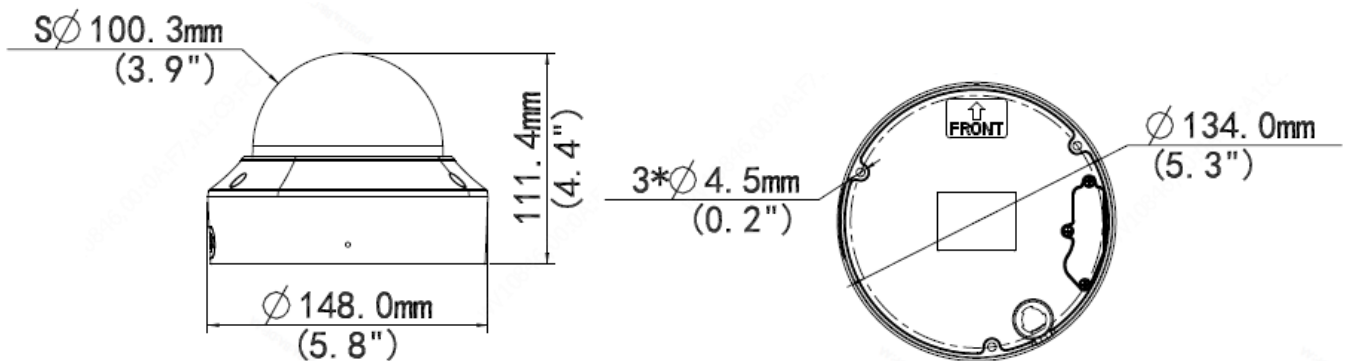

## Accessories

TR-JB04-C-IN



TR-JB07/WM04-B-IN



TR-WM04-IN



TR-FM152-A-IN

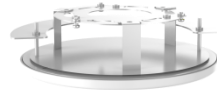

TR-UP06-IN



TR-A01-IN



TR-SM04-IN



TR-SE24-IN



TR-SE24-A-IN



TR-CM24-IN

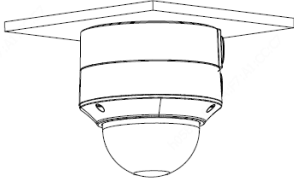
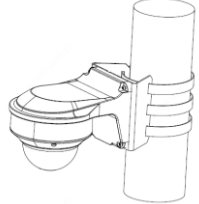
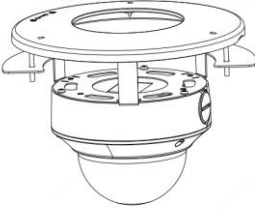
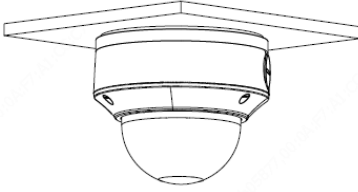
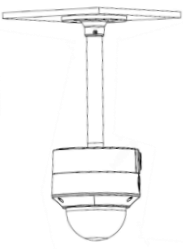

Junction box	Pole mount
TR-JB04-C-IN+TR-A01-IN	TR-JB07/WM04-B-IN (TR-WM04-IN)+ TR-UP06-IN
	
In-ceiling mount	Electric-box Transfer plate
TR-FM152-A-IN	TR-SM04-IN
	
Indoor pendent mount	
TR-JB04-D-IN+TR-A01-IN+ TR-SE24-IN(TR-SE24-A-IN)+ TR-CM24-IN	
	

**Zhejiang Uniview Technologies Co., Ltd.**

Building No.10, Wanlun Science Park, Jiangling Road 88, Binjiang District, Hangzhou, Zhejiang, China (310051)

Email: overseasbusiness@uniview.com; globalsupport@uniview.com

<http://www.uniview.com>

©2020 Zhejiang Uniview Technologies Co., Ltd. All rights reserved.

\*Product specifications and availability are subject to change without notice.