

ENGLISH

Diagram References

1 Appearance

- ① Microphone ② Indicator ③ Camera ④ Loudspeaker ⑤ Button
- ⑥ Card Reading Area ⑦ IR Light ⑧ Micro SD Card Slot(Reserved) & Debugging Port
- ⑨ Network Interface ⑩ Terminals

Note: The debugging port is used for debugging only.

Indicator Description Unlock: Green Call: Orange Communicate: White

2 Terminal and Wiring

- NC: Door Lock Relay Output (NC) 485-: RS-485 Interface (Reserved)
- NO: Door Lock Relay Output (NO) 485+: RS-485 Interface (Reserved)
- COM: Common Interface 12 VDC IN: Power Supply Input
- AIN1: For the access of Door Contact GND: Grounding
- AIN3: For the access of Exit Button LAN: Network Interface
- AIN2&AIN4: Reserved

3 Installation Accessory

- ① Mounting Template ② Mounting Plate

Note: The dimension of the mounting plate is 174 mm × 83.66 mm × 18 mm.

4 Installation

Note: Video intercom villa door station supports surface mounting.

Before You Start

- Make sure all related equipments are power-off during the installation.
- Tools that you need to prepare for installation: Drill (φ2.846) and gradienter.
- Purchase the protective shield before installation.

★ Surface Mounting without Protective Shield

1. Stick the mounting template on the wall. Drill screw holes according to the mounting template. Remove the template from the wall.
2. Secure the mounting plate on the wall with 4 supplied screws according to the screw holes.
3. Secure the device on the mounting plate with 4 supplied set screws.
4. Fix the cover onto the device with the screw.

★ Surface Mounting with Protective Shield

1. Stick the mounting template on the wall. Drill screw holes according to the mounting template. Remove the template from the wall.
2. Align the protective shield with mounting template.
3. Secure the mounting plate on the wall with 4 supplied screws according to the screw holes.
4. Secure the device on the mounting plate with 4 supplied set screws.
5. Fix the cover onto the device with the screw.

★ Surface Mounting without Protective Shield

1. Stick the mounting template on the wall. Drill the hole according to the mounting template. Remove the template from the wall. The suggested size of hole is 175 mm × 84 mm × 19 mm.
2. Install the gang box into the hole with 4 screws.
3. Insert the device to the gang box. Secure the device with 4 supplied screws.
4. Fix the cover onto the device with the screw.

★ Surface Mounting with Protective Shield

1. Stick the mounting template on the wall. Drill the hole according to the mounting template. Remove the template from the wall. The suggested size of hole is 175 mm × 84 mm × 19 mm.
2. Install the gang box into the hole with 4 screws.
3. Align the protective shield with gang box.
4. Insert the device to the gang box. Secure the device with 4 supplied screws.
5. Fix the cover onto the device with the screw.

5 Configuration via Web

1 Activate Device via Web

You are required to activate the device first by settings a strong password before you can use the device.

Default parameters of door station are as follows:

- Default IP Address: 192.0.0.65.
- Default Port No.:8000.
- Default User Name: admin

1. Power on the device, and connect the device to the network.
2. Enter the IP address into the address bar of the web browser, and click Enter to enter the activation page.

Note: The computer and the device should belongs to the same subnet.

3. Create and enter a password into the password field.
4. Confirm the password.
5. Click OK to activate the device.

Note: When the device is not activated, the basic operation and remote configuration of device cannot be performed.

2 Access to the Device by Web Browsers

1. In the browser address bar, enter the IP address of the device, and press the Enter key to enter the login page.
2. Enter the user name and password and click Login.

3 Communicate with Indoor Station

1. Click Settings -> Intercom -> Press Button to Call to enter the settings page.
 2. Set the parameters.
 - Edit call No. for every button.
 - Check Call Management Center to set the button calling center.
- Note: If you check Call Management Center and set the call No. as well, call management center has higher privilege than call No.
3. Press button to call indoor station.

4 Issue Card

1. Click Settings -> Access Control and Elevator Control to enter the settings page.
2. Click Issue Card. Present the card on the card reading area.
3. When issuing finished, the windows pop up on the settings page.

- Note:
- Only Mifare card supported, and Mifare card with non-standard shape is recommended.
 - Up to 10000 cards can be issued and managed by V series door station. A voice prompt (No more cards can be issued.) can be heard when the issued card amount exceeds the upper limit.

5 Unlock Door

After issuing cards, you can unlock the door by presenting the issued cards.

Refers to Video Intercom Villa Door Station User Manual (scan the QR code) for details.

Single-Button

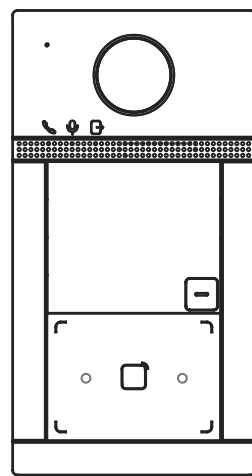

Two-Button

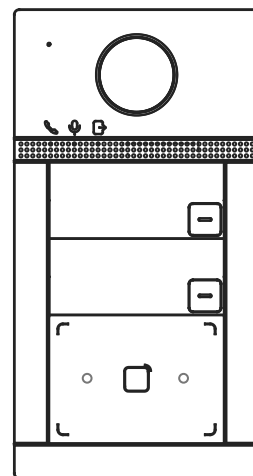

Four-Button

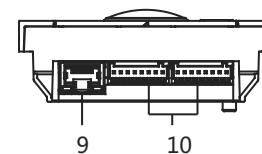
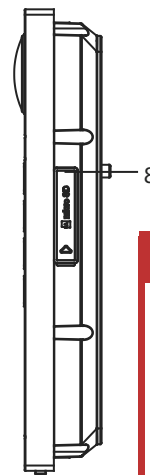
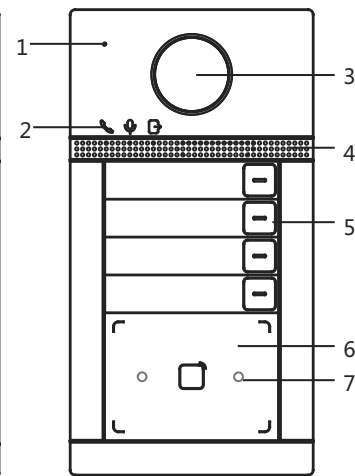

2

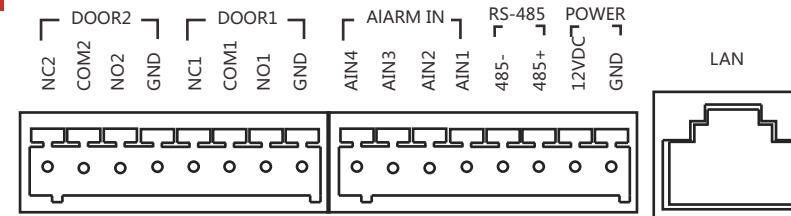

4

★ Surface Mounting without Protective Shield

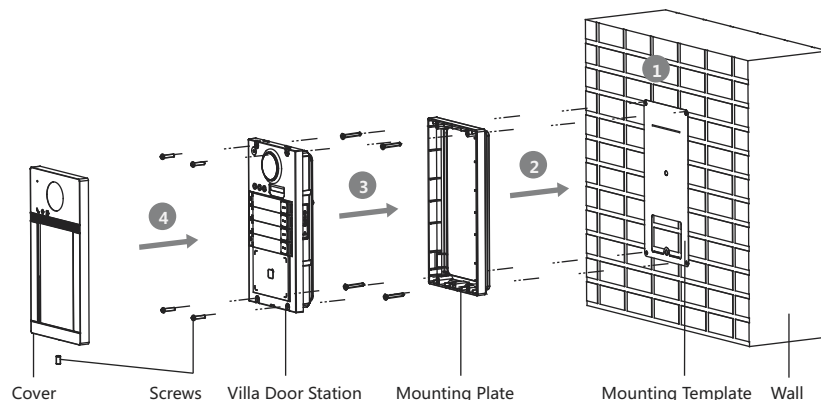

★ Surface Mounting with Protective Shield

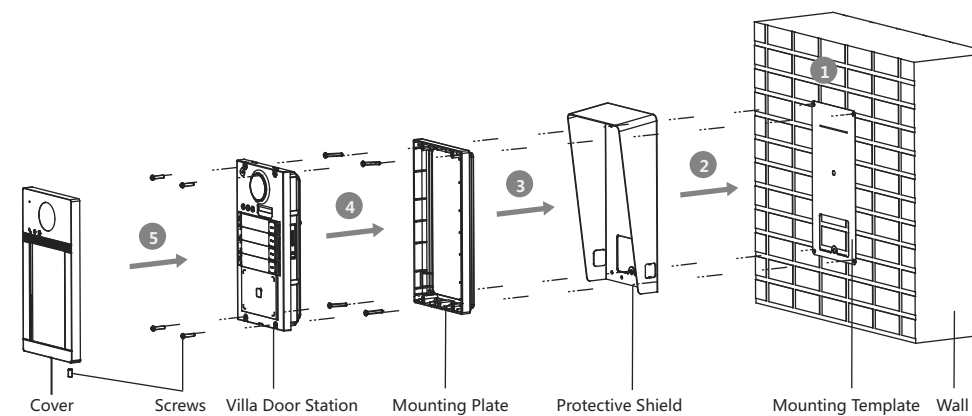

★ Flush Mounting without Protective Shield

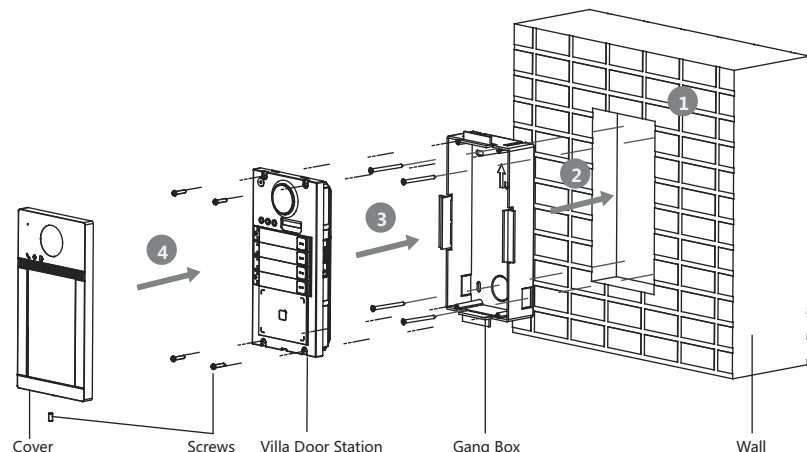

★ Flush Mounting with Protective Shield

